

Intelligent Systems Reference Library 163

Sudeep Tanwar
Sudhanshu Tyagi
Neeraj Kumar *Editors*

Multimedia Big Data Computing for IoT Applications

Concepts, Paradigms and Solutions

 Springer

Intelligent Systems Reference Library

Volume 163

Series Editors

Janusz Kacprzyk, Polish Academy of Sciences, Warsaw, Poland

Lakhmi C. Jain, Faculty of Engineering and Information Technology, Centre for Artificial Intelligence, University of Technology, Sydney, NSW, Australia;
Faculty of Science, Technology and Mathematics, University of Canberra, Canberra, ACT, Australia;

KES International, Shoreham-by-Sea, UK;
Liverpool Hope University, Liverpool, UK

The aim of this series is to publish a Reference Library, including novel advances and developments in all aspects of Intelligent Systems in an easily accessible and well structured form. The series includes reference works, handbooks, compendia, textbooks, well-structured monographs, dictionaries, and encyclopedias. It contains well integrated knowledge and current information in the field of Intelligent Systems. The series covers the theory, applications, and design methods of Intelligent Systems. Virtually all disciplines such as engineering, computer science, avionics, business, e-commerce, environment, healthcare, physics and life science are included. The list of topics spans all the areas of modern intelligent systems such as: Ambient intelligence, Computational intelligence, Social intelligence, Computational neuroscience, Artificial life, Virtual society, Cognitive systems, DNA and immunity-based systems, e-Learning and teaching, Human-centred computing and Machine ethics, Intelligent control, Intelligent data analysis, Knowledge-based paradigms, Knowledge management, Intelligent agents, Intelligent decision making, Intelligent network security, Interactive entertainment, Learning paradigms, Recommender systems, Robotics and Mechatronics including human-machine teaming, Self-organizing and adaptive systems, Soft computing including Neural systems, Fuzzy systems, Evolutionary computing and the Fusion of these paradigms, Perception and Vision, Web intelligence and Multimedia.

** Indexing: The books of this series are submitted to ISI Web of Science, SCOPUS, DBLP and Springerlink.

More information about this series at <http://www.springer.com/series/8578>

Sudeep Tanwar · Sudhanshu Tyagi ·
Neeraj Kumar
Editors

Multimedia Big Data Computing for IoT Applications

Concepts, Paradigms and Solutions

 Springer

Editors

Sudeep Tanwar
Department of Computer Science
and Engineering
Institute of Technology, Nirma University
Ahmedabad, Gujarat, India

Sudhanshu Tyagi
Department of Electronics
and Communication Engineering
Thapar Institute of Engineering
and Technology, Deemed University
Patiala, Punjab, India

Neeraj Kumar
Department of Computer Science
and Engineering
Thapar Institute of Engineering
and Technology, Deemed University
Patiala, Punjab, India

ISSN 1868-4394

ISSN 1868-4408 (electronic)

Intelligent Systems Reference Library

ISBN 978-981-13-8758-6

ISBN 978-981-13-8759-3 (eBook)

<https://doi.org/10.1007/978-981-13-8759-3>

© Springer Nature Singapore Pte Ltd. 2020

This work is subject to copyright. All rights are reserved by the Publisher, whether the whole or part of the material is concerned, specifically the rights of translation, reprinting, reuse of illustrations, recitation, broadcasting, reproduction on microfilms or in any other physical way, and transmission or information storage and retrieval, electronic adaptation, computer software, or by similar or dissimilar methodology now known or hereafter developed.

The use of general descriptive names, registered names, trademarks, service marks, etc. in this publication does not imply, even in the absence of a specific statement, that such names are exempt from the relevant protective laws and regulations and therefore free for general use.

The publisher, the authors and the editors are safe to assume that the advice and information in this book are believed to be true and accurate at the date of publication. Neither the publisher nor the authors or the editors give a warranty, expressed or implied, with respect to the material contained herein or for any errors or omissions that may have been made. The publisher remains neutral with regard to jurisdictional claims in published maps and institutional affiliations.

This Springer imprint is published by the registered company Springer Nature Singapore Pte Ltd. The registered company address is: 152 Beach Road, #21-01/04 Gateway East, Singapore 189721, Singapore

Preface

With an exponential increase in the provisioning of multimedia devices over the Internet of Things (IoT), a significant amount of multimedia big data has been generated from different devices located across the globe. Current proposals in the literature mainly focus on scalar sensor data with less emphasis on the streaming multimedia big data generated from different devices. This textbook examines the unique nature and complexity of MMBD computing for IoT applications and provides unique characteristics and applications divided into different chapters for MMBD over IoT. A number of research challenges are associated with MMBD, such as scalability, accessibility, reliability, heterogeneity, and quality-of-service (QoS) requirements. This textbook is the first-ever “how-to” guide addressing one of the most overlooked practical, methodological, and moral questions in any nations’ journeys to handle the massive amount of multimedia big data being generated from IoT devices’ interactions: For example, how to handle the complexity of facilitating MMBD over IoT? How to organize the unstructured and heterogeneous data? How to deal with cognition and understand complexity associated with MMBD? How to address the real-time and quality-of-service requirements for MMBD applications? How to ensure scalability and computing efficiency.

The book is organized into four parts. Part I is focused on technological development, which includes five chapters. Part II discussed the multimedia big data analytics, which has five chapters. Part III illustrates the societal impact of multimedia big data with well-structured four chapters. Finally, Part IV highlights the application environments for multimedia big data analytics with four chapters.

Part I Technological Developments

Chapter “[Introduction to Multimedia Big Data Computing for IoT](#)” presents an introduction to the multimedia big data computing for IoT applications. This chapter addresses the gap between multimedia big data challenges in IoT and

multimedia big data solutions by offering the present multimedia big data framework, their advantages and limitations of the existing techniques, and the potential applications in IoT. It also presents a comprehensive overview of the multimedia big data computing for IoT applications, fundamental challenges, and research openings for multimedia big data era.

Chapter “[Energy Conservation in Multimedia Big Data Computing and the Internet of Things—A Challenge](#)” highlights various ways to achieve energy conservation in the MMBD IoT environment. The authors have focused on the investigation of the existing technologies and mechanisms in the above domains. The authors have first presented the need for energy conservation briefly and then discuss the key points of the existing solutions for saving energy in IoT communications. At the end of the paper, the authors have summarized the findings to describe the advantages and limitations of the existing mechanisms and provide insights into possible research directions.

Chapter “[Deep Learning for Multimedia Data in IoT](#)” highlights the importance and convergence of deep learning techniques with IoT. Emphasis is laid on the classification of IoT data using deep learning and the essential fine-tuning of parameters. A virtual sensor device implemented in Python is used for simulation. An account of protocols used for communication of IoT devices is briefly discussed. A case study is also provided regarding the classification of Air Quality Dataset using deep learning techniques. Later in this chapter, the challenges faced by IoT are discussed, and deep learning is explained in detail. At the end, the future research directions are discussed.

Chapter “[Random Forest-Based Sarcastic Tweet Classification Using Multiple Feature Collection](#)” proposes a model with an accuracy slightly higher than 84%, which depicts a clear improvement in comparison with the existing models. The authors have used random forest-based classification model which outperformed all other candidates deployed under the experiment. Through simulations, the authors have obtained an accuracy of 84.7%, which outperforms the SVM (78.6%), KNN (73.1%), and maximum entropy (80.5%).

Part II Multimedia Big Data Analytics

Chapter “[Peak-to-Average Power Ratio Reduction in FBMC Using SLM and PTS Techniques](#)” presents an overview of a novel selective mapping (SLM) and partial transmit sequence (PTS) PAPR reduction technique which is suggested for FBMC. The authors have proposed a technique which was implemented by using an elementary successive optimization technique that upsurges the PAPR performance and ensures the design difficulty is taken low. PAPR and bit error rate (BER) parameters are analyzed and simulated for the proposed and conventional PAPR reduction techniques. The authors have performed simulation which shows that the SLM and PTS accomplished an excellent PAPR reduction up to 2.8 dB and 4.8 dB as compared to other peak power minimization techniques.

Chapter “[Intelligent Personality Analysis on Indicators in IoT-MMBD-Enabled Environment](#)” enlightens the use of personality detection test in academics, job placement, group interaction, and self-reflection. It provides the use of multimedia and IoT to detect the personality and to analyze the different human behaviors. It also includes the concept of big data for the storage and processing of the data which will be generated while analyzing the personality through IoT. In this chapter, authors have used supervised learning. Algorithms like Linear Regression, Multiple Linear Regression, Decision Tree and Random Forest to build the model for personality detection test.

Chapter “[Data Reduction in MMBD Computing](#)” provides an overarching view of data compression challenges related to big data and IoT environment. The authors have provided an overview of the various data compression techniques employed for multimedia big data computing, such as run-length coding, Huffman coding, arithmetic coding, delta modulation, discrete cosine transform, fast Fourier transform, Joint Photographic Experts Group, Moving Picture Experts Group, and H.261, including the essential theory, the taxonomy, necessary algorithmic details, mathematical foundations, and their relative benefits and disadvantages.

Chapter “[Large-Scale MMBD Management and Retrieval](#)” introduces the basics of multimedia data and the emergence of big data in multimedia. Then, the requirements that are essential for a Multimedia Database Management System to function properly and produce efficient results are discussed. Further, this chapter covers the annotation and indexing techniques that help manage a large amount of multimedia data. Finally, a detailed description of the databases can be put to use for storing, managing, and retrieving the multimedia big data.

Chapter “[Data Reduction Technique for Capsule Endoscopy](#)” explores data reduction techniques with the aim of maximizing the information gain. This technique exhibits high variance and low correlation to achieve this task. The proposed data reduction technique reduces the feature vector which is fed to a computer-based diagnosis system in order to detect ulcer in the gastrointestinal tract. The proposed data reduction technique reduces the feature set to 98.34%.

Part III Societal Impact of Multimedia Big Data

Chapter “[Multimedia Social Big Data: Mining](#)” presents an extensive and organized overview of the multimedia social big data mining. A comprehensive coverage of the taxonomy, types, and techniques of multimedia social big data mining is put forward. Then, a SWOT analysis is done to understand the feasibility and scope of social multimedia content and big data analytics is also illustrated. They concluded with the future research direction to validate and endorse the correlation of multimedia to big data for mining social data.

Chapter “[Advertisement Prediction in Social Media Environment Using Big Data Framework](#)” describes an advertisement prediction framework which uses prediction approaches on big data platforms. In addition, social media platforms are

used to collect data that is based on user interest. The authors have performed experiments on real-time data that is collected from social media platforms. Finally, the proposed framework can be served as a benchmark for business companies to send the appropriate advertisement to the individuals.

Chapter “[MMBD Sharing on Data Analytics Platform](#)” explores the field of multimedia big data sharing on data analytics platform. Multimedia data is a major contributor to the big data bubble. The authors have discussed various ways of data sharing. Further, this chapter covers cloud services as a recently developed area for storage and computation. Impacts of social media giants like Facebook and Twitter along with Google Drive have been discussed. Finally, this chapter ends with a brief mention of the security of online data and analysis of the MMBD.

Chapter “[Legal/Regulatory Issues for MMBD in IoT](#)” details the fundamental issues related to the use of MMBD in IoT applications and also presents a systematic discussion of some emerging questions regarding the transfer and use of data across the Internet. Thus, strict penalties are needed to be imposed on the offenders and misusers of MMBD, and an adequate legal framework is discussed in this chapter which addresses the regulatory and legal issues for MMBD in IoT that are required.

Part IV Application Environments

Chapter “[Recent Advancements in Multimedia Big Data Computing for IoT Applications in Precision Agriculture: Opportunities, Issues, and Challenges](#)” presents a survey on the existing techniques and architectures of MMBD computing for IoT applications in precision agriculture, along with the opportunities, issues, and challenges it poses in the context. As a consequence of the digital revolution and ease of availability of electronic devices, a massive amount of data is being acquired from a variety of sources. Moreover, this chapter focuses on major agricultural applications, cyber-physical systems for smart farming, multimedia data collection approaches, and various IoT sensors along with wireless communication technologies, employed in the field of precision agriculture.

Chapter “[Applications of Machine Learning in Improving Learning Environment](#)” presents various machine learning approaches that help educators to make the teaching and learning environment more fun and challenging with the aid of intelligent technologies and take our education to new heights, as soon as education system implements the machine learning concept in their curriculums.

Chapter “[Network-Based Applications of Multimedia Big Data Computing in IoT Environment](#)” gives a brief introduction on IoT with its structure. Then, different technologies are discussed in the field of IoT. The authors have described various application areas of IoT. Finally, big data and the importance of IoT-based sensor devices in big data are presented.

Chapter “[Evolution in Big Data Analytics on Internet of Things: Applications and Future Plan](#)” discusses some applications and explains the utilization of big

data and IoT in brief. Secondly, the deficiencies are also the matter of concern in this chapter. The desired solutions to overcome the drawbacks of the big data and Internet of Things are also discussed. The authors also have presented the development in the subject of big data on the Internet of things applications.

The editors are very thankful to all the members of Springer (India) Private Limited, especially Mr. Aninda Bose, for the given opportunity to edit this book.

Ahmedabad, Gujarat, India
Patiala, Punjab, India
Patiala, Punjab, India

Dr. Sudeep Tanwar
Dr. Sudhanshu Tyagi
Dr. Neeraj Kumar

Contents

Part I Technological Developments

Introduction to Multimedia Big Data Computing for IoT	3
Sharmila, Dhananjay Kumar, Pramod Kumar and Alaknanda Ashok	
Energy Conservation in Multimedia Big Data Computing and the Internet of Things—A Challenge	37
Pimal Khanpara and Kruti Lavingia	
An Architecture for the Real-Time Data Stream Monitoring in IoT	59
Mario José Diván and María Laura Sánchez Reynoso	
Deep Learning for Multimedia Data in IoT	101
Srinidhi Hiriyannaiah, B. S. Akanksh, A. S. Koushik, G. M. Siddesh and K. G. Srinivasa	
Random Forest-Based Sarcastic Tweet Classification Using Multiple Feature Collection	131
Rajeev Kumar and Jasandeep Kaur	

Part II Multimedia Big Data Analytics

Peak-to-Average Power Ratio Reduction in FBMC Using SLM and PTS Techniques	163
Arun Kumar and Manisha Gupta	
Intelligent Personality Analysis on Indicators in IoT-MMBD-Enabled Environment	185
Rohit Rastogi, D. K. Chaturvedi, Santosh Satya, Navneet Arora, Piyush Trivedi, Akshay Kr. Singh, Amit Kr. Sharma and Ambuj Singh	
Data Reduction in MMBD Computing	217
Yosef Hasan Jbara	

Large-Scale MMBD Management and Retrieval	247
Manish Devgan and Deepak Kumar Sharma	
Data Reduction Technique for Capsule Endoscopy	269
Kuntesh Jani and Rajeev Srivastava	
Part III Societal Impact of Multimedia Big Data	
Multimedia Social Big Data: Mining	289
Akshi Kumar, Saurabh Raj Sangwan and Anand Nayyar	
Advertisement Prediction in Social Media Environment Using Big Data Framework	323
Krishna Kumar Mohbey, Sunil Kumar and Vartika Koolwal	
MMBD Sharing on Data Analytics Platform	343
Manish Devgan and Deepak Kumar Sharma	
Legal/Regulatory Issues for MMBD in IoT	367
Prateek Pandey and Ratnesh Litoriya	
Part IV Application Environments	
Recent Advancements in Multimedia Big Data Computing for IoT Applications in Precision Agriculture: Opportunities, Issues, and Challenges	391
Shradha Verma, Anshul Bhatia, Anuradha Chug and Amit Prakash Singh	
Applications of Machine Learning in Improving Learning Environment	417
Pallavi Asthana and Bramah Hazela	
Network-Based Applications of Multimedia Big Data Computing in IoT Environment	435
Anupam Singh and Satyasundara Mahapatra	
Evolution in Big Data Analytics on Internet of Things: Applications and Future Plan	453
Rohit Sharma, Pankaj Agarwal and Rajendra Prasad Mahapatra	

About the Editors

Sudeep Tanwar is an Associate Professor in the Computer Science and Engineering Department at the Institute of Technology of Nirma University, Ahmedabad, India. He is invited as a Visiting Professor by the Jan Wyzykowski University Polkowice, Polkowice, Poland and University of Pitesti, Pitesti, Romania. He received his Ph.D. in 2016 from the Faculty of Engineering and Technology, Mewar University, India, with a specialization in Wireless Sensor Networks. His research interests include routing issues in WSN, Network Security, Blockchain Technology, and Fog Computing. He has authored four books: Energy Conservation for IoT Devices: Concepts, Paradigms and Solutions (ISBN: 978-981-13-7398-5), Routing in Heterogeneous Wireless Sensor Networks (ISBN: 978-3-330-02892-0), Big Data Analytics (ISBN: 978-93-83992-25-8), and Mobile Computing (ISBN: 978-93-83992-25-6). He is an associate editor of the Security and Privacy Journal, and is a member of the IAENG, ISTE, and CSTA.

Dr. Sudhanshu Tyagi is an Assistant Professor in the Department of Electronics and Communication Engineering, Thapar Institute of Engineering and Technology, Deemed University, India. He is invited as a Visiting Professor by the Jan Wyzykowski University Polkowice, Polkowice, Poland. He received his Ph.D. in 2016 from the Faculty of Engineering and Technology, Mewar University, India, with a specialization in Wireless Sensor Networks; and a Master's degree in Technology with honors in Electronics & Communication Engineering in 2005 from the National Institute of Technology, Kurukshetra, India. His research focuses on wireless sensor networks and body area sensor networks. He has co-authored two books: Big Data Analytics (ISBN: 978-93-83992-25-8), and Mobile Computing (ISBN: 978-93-83992-25-6). He is an associate editor of the Security and Privacy Journal, and is a member of the IEEE, IAENG, ISTE, and CSTA.

Dr. Neeraj Kumar is currently an Associate Professor in the Department of Computer Science and Engineering, Thapar Institute of Engineering and Technology, Deemed University, India. He received his Ph.D. degree in Computer Science and Engineering from Shri Mata Vaishno Devi University, India, in 2009. He was then a Postdoctoral Research Fellow at Coventry University, U.K. His research focuses on distributed systems, security and cryptography and body area networks. He is on the editorial board of the Journal of Network and Computer Applications and the International Journal of Communication Systems. He has published more than 200 research papers in leading journals and conferences in the areas of communications, security and cryptography. He is also a member of the IEEE and IEEE ComSoc.

Part I
Technological Developments

Introduction to Multimedia Big Data Computing for IoT



Sharmila, Dhananjay Kumar, Pramod Kumar and Alaknanda Ashok

Abstract The headway of new technology, the Internet of Things (IoT) assumes an active and central role in smart homes, wearable gadgets, agricultural machinery, retail analytics, engagement on energy resources, and healthcare. The boom of the internet and mobility support this proliferation in all these smart things, and massive production of multimedia big data of different formats (such as images, videos, and audios) daily. Multimedia applications and services provide more opportunities to compute multimedia big data. Most of the data generated from IoT devices such as a sensor in the devices, actuators, home appliances, and social media. In the near future, IoT will have a significant impact in broader domains such as healthcare, smart energy grids and smart cities in the name of IoT big data applications. More research work has been carried out in the multimedia big data in the different aspects such as acquisition of data, storage, mining, security, and retrieval of data. However, a few research work offers a comprehensive survey of the multimedia big data computing for IoT. This chapter addresses the gap between multimedia big data challenges in IoT, and multimedia big data solutions by offering the present multimedia big data framework, their advantages, and limitations of the existing techniques, and the potential applications in IoT. It also presents a comprehensive overview of the multimedia big data computing for IoT applications, fundamental challenges, and research openings for multimedia big data era.

Sharmila (✉) · D. Kumar · P. Kumar

Department of Computer Science Engineering, Krishna Engineering College, Ghaziabad 201007, Uttar Pradesh, India
e-mail: r.sharmila@krishnacollege.ac.in

D. Kumar

e-mail: dhananjay.kumar@krishnacollege.ac.in

P. Kumar

e-mail: pramodkumar.hod@krishnacollege.ac.in

A. Ashok

Women Institute of Technology, Dehradun, Uttarakhand Technical University, Dehradun, Uttarakhand, India
e-mail: alagn@rediff.com

© Springer Nature Singapore Pte Ltd. 2020

S. Tanwar et al. (eds.), *Multimedia Big Data Computing for IoT Applications*, Intelligent Systems Reference Library 163, https://doi.org/10.1007/978-981-13-8759-3_1

Keywords Big data · Internet of things · Multimedia data · Unstructured data · Data computing

1 Introduction

Regular ascend in new technologies and their accessibility coupled with the availability of multimedia sources, the rapid and extensive use of multimedia data such as videos, audios, images, and text have been increasing day by day. Currently, sources of multimedia big data are YouTube, Facebook, Flickr, iCloud, Instagram, Twitter, etc. For example, every minute, the people are uploading 100 h of videos in YouTube, per day the user send approximately 500 million of messages in Twitter; nearly, 20 billion photos are in Instagram [1]. The statistical analysis illustrates that due to the multimedia data sharing over the internet has reached nearly 6,130 PB every month in the year 2016. In 2020, the digital data rate surpasses 40ZB [2]. From this analysis, each person in the world generates nearly 5,200 GB of data.

Due to the advancement in the technology, the people spend most of the time on the internet and social networks to share and communicate their information in the form of multimedia data [3] such as audio, videos, text, images, etc. Multimedia big data is considered as a large volume of the information. Such multimedia big data is characterized in terms of its massive volume, diverse Variety, and rapid velocity. These data are mostly unstructured and may contain much noisy information. The processing and analyzing of these data becomes difficult using the traditional data handling and analytic tools because the traditional datasets, which consist of text and number. Therefore, the multimedia big data requires more extensive and sophisticated solutions to handle the large volume of unstructured data [4]. The major problem which needs to be analyzed efficiently and effectively by multimedia big data analytics such as data handling, data mining, visualizing, and understanding the different datasets generated by multimedia sources to handle real-time challenges. Multimedia applications and services provide more opportunities to compute multimedia big data. By 2020, it is anticipated that 4×10^{24} bytes may be generated. Studies lead by CISCO, and IBM states that 2.5 quintillions of data are generated each day making it equivalent to 5200 GB per person in the universe. Most of the data is generated from IoT devices such as a sensor in the devices, actuators, home appliances, and social media. Internet of Things (IoT) also offers new challenges to multimedia big data owing to the mobility of IoT devices, data gathering from omnipresent sensor devices, and Quality of Experience (QoE). In this chapter, an extensive overview of the multimedia big data challenges, impact of multimedia big data in IoT, characteristics of multimedia big data computing in 10 V's perspective, and further, addressed the opportunities and future research direction of multimedia big data in IoT.

1.1 *Big Data Era*

The big data concept is essential to understand the characteristics, challenges, and opportunities for multimedia big data. The following section provides the dawn of big data and its challenges. Over the past two decades, the amount of data has increased in a huge amount in different fields. In 2011, the International Data Corporation (IDC) studied and revealed that the entire volume of data generated and the size of data copied has grown ninefold within 5 years worldwide to 01.8×10^{21} Bytes (ZB) of data. Shortly, this numeral twice at least every 2 years [5]. Due to the massive growth in data globally, big data is predominantly utilized for explaining the huge amount of datasets. Big data needs much instant analysis as compared to traditional dataset because of unstructured data. Recently, industries and government agencies development an interest in this enormous volume of data and declared the first plans in the direction of research and applications in big data [6]. The big data challenges and concerns are extensively reported in public media [7–9]. Big data provides novel opportunities for realizing new values, to gather detailed knowledge about concealed values and also acquires in what way the data is to organize and manage multimedia datasets efficiently. At present, a large volume of data is generating rapidly from the source of Internet. For example, Facebook produces over 10 PB (Petabyte) of data log per month; Google deals with 100 s of PB of data, for online trading, Alibaba produces tens of terabyte of data for per day [10]. Advancement of IoT also contributes significantly to generating a large amount of data rapidly. For example, in YouTube, people are uploading an average of 72 h of videos per minute [10].

There is no abstract definition for big data. In 2001, Doug Laney addressed the issues and chances took by enlarged data concerning the 3 V's model, i.e., Volume, Velocity, and Variety. IBM [11] and Microsoft research department [12] have been used 3 V's model to outline the big data within the subsequent fifteen years. The 3 V's model represents Velocity, Volume, and Variety [13]. The Volume represents the large volume of data generation and collection, Velocity represents the speed of data generation, and Variety means the diverse forms of data which contain structured, unstructured, and semi-structured data such as text, audio, videos, web pages, etc. Apache Hadoop well stated the big data as the traditional computers which not able to process, and analyses the datasets in the year 2010 [14]. In 2011, McKinsey & Company defined big data as the succeeding level for the invention, rivalry, and productivity. In 2011, big data ranged from TB to PB [15]. The key features addressed by McKinsey & Company include increasingly growing of big data as well as management of big data.

The traditional database technologies could not manage the big data. Though, people still have different views, including the most powerful important frontrunner in the investigation fields of big data is International Data Corporation (IDC). IDC defines the big data as the new-fangled advancement of technologies and architectures, intended to retrieve the value economically from a huge amount of a diverse variety of data. Further, the big data considered as 4 V's such as Volume, Variety, Velocity, and Value. This characterization addressed the utmost difficult part in big

data, which is in what way to extract the values from a large volume of datasets. The extensive discussions have been carried out by academicians and industry on the characterization of big data [16].

1.2 *Big Data Challenges*

The big data provides more challenges such as data storage, to manage the data, data acquisition, and analysis. Traditional Relational Database Management System (RDBMS) is not suitable for unstructured and semi-structured data. The database management and analysis relies on RDBMS, which uses more expensive hardware. The traditional relational database management system could not manage the large capacity and diversity of big data concerning different types of data and sources. On a different perspective, the research community has proposed a solution to handle a large volume of big data. For example, distributed file system and NoSQL [17] databases provide the permanent solution to store and manage the large-scale chaotic datasets, and the cloud computing provides a solution to satisfy the needs on infrastructure for big data. Various technologies are developed for the applications of big data applications. Some author [18] addressed the issues and difficulties of the big data applications.

Some of the big data challenges are as follows:

- **Data Representation:** The different levels of big datasets such as structure, semantics, granularity, and openness. The main goal of data representation is that the data is more significant for computer analysis and user comprehensible. The inappropriate way of data representation reduces the originality of data and analysis. An efficient data representation achieves an efficient data operation on datasets.
- **Redundancy reduction and data reduction:** Big datasets have a large number of redundant data. It is an efficient method to decrease the highly redundant data generated by sensor networks from IoT applications and reduces the cost of the whole system.
- **Analytical mechanism:** Within the limited amount of period, the analytical mechanisms of big data process the vast volume of heterogeneous data. Traditional RDBMS has the limitation of scalability and expandability, which could not encounter the performance requirements. The non-relational databases system could process the unstructured data. It is the unique advantage of non-relational databases system; still, some problems are encountered in terms of performance and specific applications. The best solution to overcome the tradeoff of relational and non-relational databases for big data is mixed database architecture (Facebook and Taobao), which integrates the advantages of both.
- **Expendability and Scalability:** The logical scheme and algorithm for big data should sustain the current as well as forthcoming datasets and process the enormous growth of complex data.

- **Energy Management:** The energy consumption is a significant problem, which brings the attention of economy of the country. The different operations of multimedia big data such as acquisition, processing, analysis, storing, and broadcasting of the huge volume of big data consumes more energy. The system-level power depletion and managing established to ensure the expandability and accessibility of big data.

1.3 Big Data Applications in Multimedia Big Data

The multimedia big data management system depends on the big data techniques to process and manipulate the multimedia big data efficiency.

The application of big data in multimedia big data analytics are as follows,

- **Social Networks:** Many research works have been performed on social network big data analysis [19]. Tufeki et al., analyses the challenges of social activities and behaviors of people on Twitter hashtags, which has a large number of datasets, visibility, and ease of access. Ma et al. address the new emerging technology called social recommender system, and it is mainly used in social networks to share multimedia information. Davidson et al. presented YouTube video framework activities in which it integrates social information and personalizes videos in a recommendation system [18].
- **Smartphones:** Recently, smartphones have overhauled the usage of other electronic devices such as personal computers, and laptops. The smartphones have advanced technologies and capabilities such as Bluetooth, Camera, network connection, Global Positioning System (GPS), and high potential Central Processing Unit (CPU), etc. Using smartphones, the user can manipulate, process, and access the heterogeneous multimedia data. Mobile sensing issues of smartphones sensors and data analyses such as data sharing, influence, security, and privacy issues are addressed by Lane et al. [19]. The other challenges of smartphones are investigated such as the large volume of data, security, and multimedia cloud computing.
- **Surveillance Videos:** The significant sources of multimedia big data is surveillance videos. Xu et al. [20] present the dawn of big data innovative solutions for multimedia big data such as volume, velocity, variety, and value of multimedia generates from surveillance sources such as traffic control, IoT, and criminal investigation. Shyu et al. [21] present the concept of how to detect semantic concept from the surveillance videos. One of the promising applications of multimedia big data is smart city surveillance.
- **Other applications:** The applications of multimedia big data can be categorized as health informatics, smart TVs, Internet of Things (IoT), disaster management system, etc. The biomedicine data and healthcare data are considered as the primary origin of the multimedia big data. It consists of variety and a huge size of data such as patient records, medical images, physician prescription, etc. Kumari

et al. [22] examined the part of IoT, fog computing, and cloud computing for health care service.

2 Definition and Characteristics of Multimedia Big Data

Multimedia big data is the theoretical concept. There is no particular description for multimedia big data. Multimedia big data concept differs from big data in terms of heterogeneous, human-centric, different forms of media, and larger size as related to the typical big data.

Some of the features of multimedia big data are given below:

- Multimedia big data comprises an enormous number of data types as compared to traditional big data. Multimedia datasets are more understandable by a human as compared to the machines.
- The multimedia big data is more difficult to processing as compared to traditional big data because which consists of different types of audio, and videos data such as interactive videos, stereoscopic three-dimensional videos, social videosm and so forth.
- It is challenging to model and characterize the multimedia big data as these data are collected from diverse (heterogeneous) sources such as pervasive portable mobile devices, the sensor-embedded devices, the Internet of Things (IoT), Internet, digital games, virtual world, and social media.
- It is thought-provoking to analyze the content and context of multimedia big data, which is not constant over a period of time and space.
- Security of multimedia big data is complicated due to rapid increases in the sensitive video data on communication.
- There is a necessity to process the multimedia big data swiftly and uninterruptedly in order to cope with the transmission speed of the network. For real-time computing, the multimedia big data is needed to be stored in order to transfer the enormous amount of data in real time.

From the above discussed characteristics, it is observed that the scientific multimedia big data leads to some fundamental challenges such as cognition and understanding complexity, analyzing complex and heterogeneous data, difficult to manage the security of distributed data, quality of experience, quality of service, detailed requirements, and performance restriction that arises from multimedia big data applications. The abovementioned challenges are associated with processing, storing of multimedia big data, transmission, and analysis, which leads to more research directions in an area of multimedia big data.

Figure 1 shows the diverse sources of multimedia big data. The term big data is used to refer those datasets, which could be no longer handled by traditional data processing and analyzing application software because of a large volume of size and complexity. The massive volume of datasets is both structured and unstructured, which is very challenging to perform different types of task such as querying, sharing

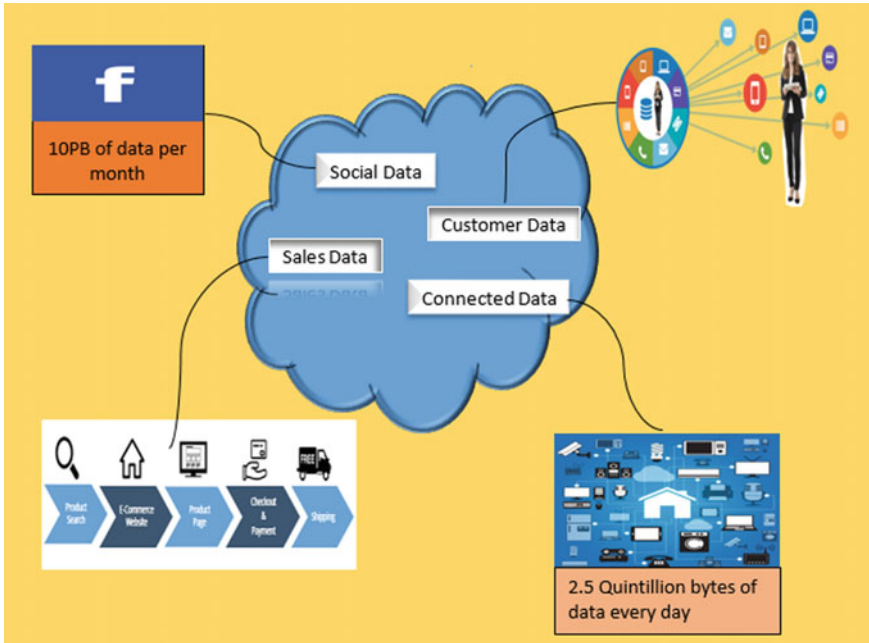

Fig. 1 Different sources of multimedia big data

of data, transferring, updating, collecting, storing, visualizing, analyzing, security, and privacy. The unstructured data does not have any fixed row and column format. Examples of unstructured data are picture files, auditory files, audiovisual files, webpages, and different kinds of multimedia contents.

It does not fit appropriately into a database. As compared to structured data, the unstructured data proliferate every second. The two different data of unstructured dataset are the captured data and user-generated. The captured data is generated based on users behavior. A user itself generates user-generated data. Examples of user-generated data are comments, posts, photos, and videos posted by a user on Facebook (Facebook.com 2016), Twitter (Twitter.com 2016), tweets, re-tweets, YouTube (Youtube.com 2016), etc. The structured data types refer to that data which has a static size and organized. It could be managed and stored easily in a database.

2.1 Challenges of Multimedia Big Data

As compared to the traditional big data(text-based big data), the multimedia big data has more challenges related to basic operations like storing of enormous datasets, processing, transmission, and analysis of data. Figure 2 depicts the multimedia big data and its challenges.

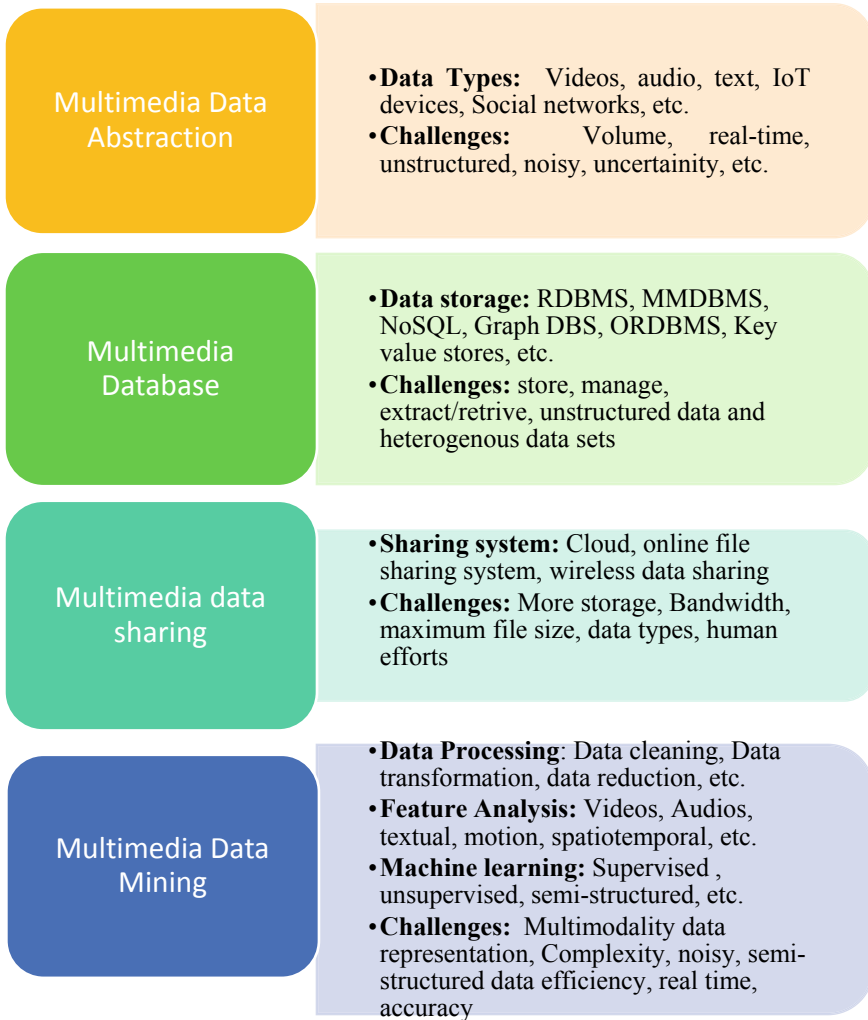

Fig. 2 Multimedia big data and its challenges

The following points are some of the challenges of multimedia data:

- **Real time and quality of experience requirements:** The services provided by multimedia big data is on real time. It is difficult to address the problem of Quality of Experience and its requirements, which needs to perform real-time streaming online, concurrently process the data for analysis, learning, and mining.
- **Unstructured and Multimodal data:** The representation of multimedia big data is challenging to store, and modeling due to unstructured and multimodal data which is acquired from heterogeneous sources. It is very thought-provoking to

transform unstructured multimedia data into structured data and representation of multimedia big data due to the data gathering from different sources.

- **Perception and understanding complexity:** Multimedia data cannot be readily understood by computer due to the high-level and low-level semantics gap between semantics. Furthermore, multimedia data vary for time and space.
- **Scalability and efficiency:** Multimedia big data systems are required to perform huge computation, so it must enhance communication resources, computation, and storage resources.

The above fundamental challenges lead to four logical problems as follows:

1. **Representation and Modeling:** In what way the unstructured data is converted into structured datasets? How to create representation and modeling for the multimedia data gathered from heterogeneous sources, unstructured data, and multimodal data?
2. **Data Computing:** How effectively can we can perform data mining and learning to examine the data?
3. **Online Computing:** In what way concurrently analyze, process, data mining, and learn the real-time multimedia data received in a parallel way?
4. **Computing, storage, and communication optimization:** In what way design a multimedia architecture to efficiently use storage, processing, and communication?

3 The Relationship Between IoT and Multimedia Big Data

In the rapid development of the IoT, a huge number of sensors are set into the numerous devices from personal electronics applications to industrial machines, which are connected to the internet. The embedded sensors are acquired from various kinds of data such as home appliances, environmental data, scientific data, geographical data, transportation data, medical data, personal human data, mobile equipment data, public data, and astronomical data. The multimedia big data, which collects from IoT devices have diverse characteristics as compared with typical big data due to the diverse characteristics of sources such as heterogeneity, different types of data (video, audio, and image), unstructured feature, noise, etc.

According to the report by IHS Markit, by 2030, the number of connected IoT devices can exceed 125 billion, and then an enormous amount of IoT data generated. Current technologies available to process the multimedia big data is not enough to face challenges in the future era. Many IoT operators realize that the importance and advancement of multimedia big data on IoT. It is essential for adopting the applications of IoT on the development of multimedia big data. The rapid growth of IoT, an enormous amount of multimedia data provides more openings for the growth of multimedia big data. These two well-known technological developments are mutually dependent on each other and should be developed together, which also provides more openings for the research on IoT.

4 Multimedia Big Data Life cycle

The emergence of IoT device is having a more significant impact on multimedia big data life cycle. The fundamental challenges addressed with the help of multimedia life cycle stages.

The figure shows the different stages of a multimedia life cycle, which consists of data collection, processing, storage, dissemination, and presentation [23]. Figure 3 depicts the multimedia big data life cycle and Fig. 4 shows the key technologies of multimedia big data.

4.1 Generation and Acquisition of Data

Data Generation. The first phase of multimedia big data life cycle is data generation. The best example of multimedia big data is Internet data. A large amount of Internet data is generated from surfing data, forum posts, chat records, blog messages, and videos. These data are day-by-day activities of people’s lives, which is generated from diverse heterogeneous sources such as camera clicks, sensors, videos, etc. The primary sources of multimedia big data are sensing information from connected devices (Internet of Things), data generated from scientific research, people’s communication and location information, trading datasets in enterprises, etc. Multimedia big data is mainly generated from IoT, which is the primary source of big data. Big data are generated from IoT-enabled smart cities, industries, agriculture field, traffic, transportation, medical data, public department, etc.

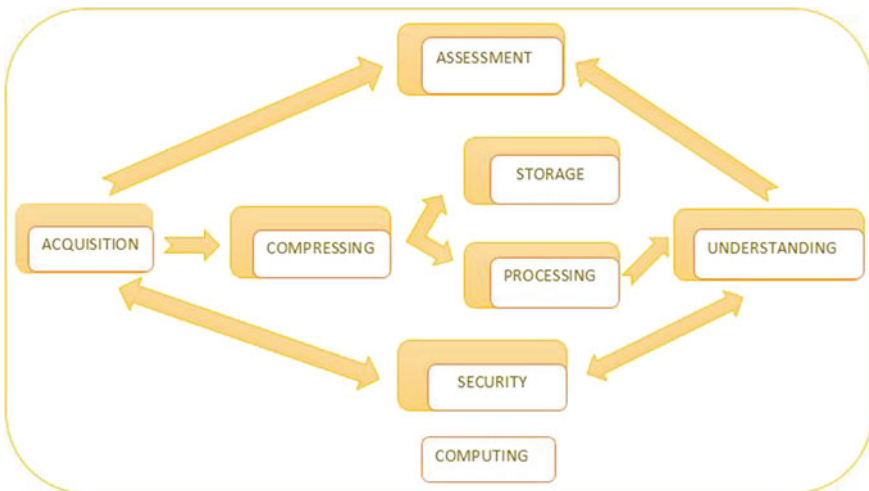

Fig. 3 Different phases of the multimedia life cycle

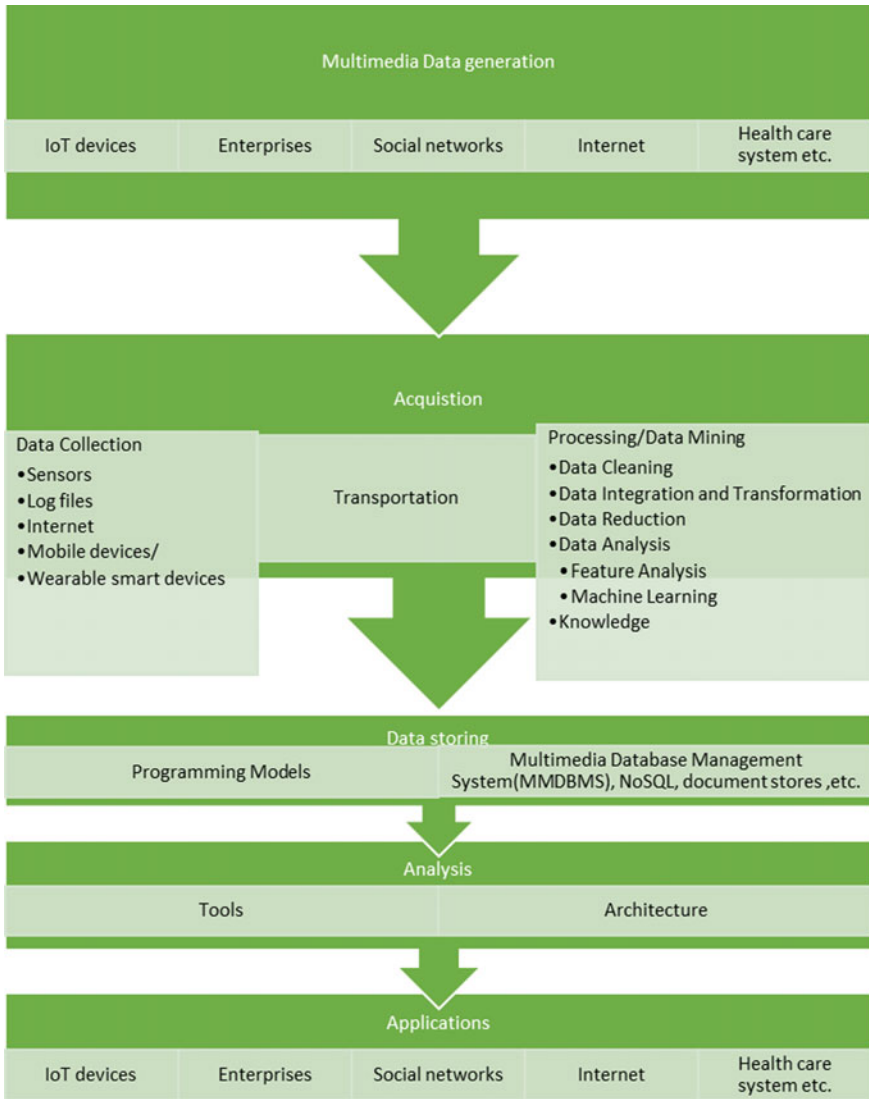

Fig. 4 Key technologies in multimedia big data

Data Acquisition. Acquisition is the first phase of the multimedia life cycle to get multimedia data from heterogeneous sources, Internet of Things (IoT), sensor, actuator, social media, digital games, etc. Different types of multimedia big data are generated from the sources such as audio, 2D, 3D virtual worlds, videos from the camera, online streaming videos, social video, Hypertext Markup Language (HTML), tables, etc. Recently, researchers proposed many standards for video coding. As compared to typical big data, it has a high level of difficulty in acquiring data from different sources due to the unstructured way of data representation. The unstructured datasets are proliferating regarding volume, size, and quality. These features of multimedia big data can offer opportunities to design new representation methods to deal with complex and heterogeneous datasets. Table 1 depicts the comparison of multimedia big data sets with other datasets such as representative dataset and big data.

IoT Multimedia big data generation and acquiring. To process an acquired multimedia data from IoT devices and for transmission, the network layer is divided into different layers such as the physical (sensing) layer, application layer, and the network layer. The acquisition is carried out by sensing layer, which consists of sensor networks. The information transmission and processing are carried out by the network layer. The sensor network is responsible to perform transmission with in the range and long distance transmission is carried out with the help of internet. The application services of the Internet of Thing are carried out by the application layer. The features of data generated from IoT as follows:

- Large-scale multimedia data;
- Heterogeneity;
- A limited amount of data due to noises;
- Robust time and space correlation.

Table 1 Characteristics of multimedia big data, typical datasets, and big data

Characteristics	Typical datasets	Big data	Multimedia
Volume	Less	Medium	Big
Data size	Definite	Uncertain	Uncertain
Inferring video	Not at all	No	Yes
Representation of data	Structured data	Structured data	Unstructured data
Real-Time	Not at all	Yes	Yes
Human-centric	Not at all	No	Yes
Response	No	No	Yes
Data source	Centralized	Heterogeneous distributed	Heterogeneous distributed
Complexity	Low	Medium	High

4.2 Data Compression

The size of multimedia big data decreased to store, communicate, and process the data efficiently. Multimedia data compression refers to eliminate the redundant data in the dataset. Redundant data refers to duplications or additional data in the datasets, which increases the data inconsistency, storage space, data transmission cost and delay, and reduction of data reliability.

Feature-transformation-based data compression: The numerical data reduction is carried out by compressive sensing and wavelet transform.

- **Cloud-based compression:** A large amount of multimedia data is produced today with the advent of IoT era. In the current scenario, many organizations are moving toward the cloud to store an enormous volume of multimedia data, which leads to storage issues in cloud computing. The storage issues are related to space, time, access control, validation, etc. Facebook has declared that 300 billion pictures are shared per day. Microsoft has announced that its cloud storage service accommodates approximately 11 billion pictures. Many efficient compressing techniques are available regarding space and time to store multimedia data efficiently in a cloud. Subsequently, research on multimedia data compression for cloud computing is of increasing importance in the computer society.

4.3 Multimedia Data Representation

The multimedia data which received from the different sources and each source represents the data in different format. For multimodal analysis, it needs a common representation of data. Multimedia data representation comprises of the following different methods:

1. **Feature-based data representation:** Some features of multimedia big data are standard regarding space or time; feature-based data representation is used to extract the data among all different combination of features. Currently, many types of research are being carried on feature vectors to retrieve the content-based multimedia data. According to the applications, from the audio, video streams, or image pixels, the features are extracted and combined into vectors. The application-based approach leads to scalability, and accuracy lack in feature-based data representation.
2. **Learning-based representation:** The common feature space extraction is a challenging task in multimedia big data due to the large volume of data gathered from different sources. A new representation which used to extract the hidden space is called learning or machine based representation.

Many learning-based representation approaches have been suggested to signify multimedia big data. Predominantly, in recent years, deep architectures are extensively applied for data learning representation.

4.4 Data Processing and Analysis

Once the data is acquired and stored, the next phase of the life cycle is data processing and analysis. The raw multimedia data, which is received from different heterogeneous sources are unstructured and noisy. The unstructured large-scale multimedia datasets are not directly suitable for analysis because of sparse, noisy, and diverse data, which causes troublesome and sometimes unfeasible. The problem as mentioned earlier can be alleviated by preprocessing methods. Data preprocessing is the process of conversion of unusable data into new and cleaned data for further analysis. After the data preprocessing, the datasets are ready for further higher level analysis.

Multimedia preprocessing of data comprises data cleaning, data transformation, and data reduction [24] as follows:

Data Cleaning: According to the reports, data scientists are spending almost 60% of the time on data organizing and cleaning. Data organization and cleaning [23] comprises of noise reduction, acquisition, outlier identification, and avoiding inconsistencies. Data cleaning can improve the data quality and reduce the discrepancy and faultiness of data. Data imputation methods have been used to handle the missing data values. To improve the final results, error-aware data mining approach incorporates the noise information in it. The noisy semi-structured data is converted into clean data with the help of data manipulation and preprocessing tools.

Data Integration and Transformation: Data integration is the process of combining the heterogeneous sources, as well as, their metadata into a consistent source. It detects data conflicts and resolves it. Data transformation is another crucial step in preprocessing. Data transformation includes data formatting, aggregation, and normalization. Recently, extensive research work [25] is going on to develop a common representation model to transform different data into enhanced, and simplified data.

Data reduction: Recently, many data compression techniques is proposed to handle a large amount of multimedia data. Researches mainly focused on feature reduction and instance reduction. In instance reduction technique [26], the quality of mining model is improved by reducing the original datasets as well as the complexity of the data without affecting the original data structure and integrity of the data.

- **Data Analysis:** As multimedia big data research is advanced due to the development of IoT, the typical data analysis is a new complication on multimedia big data processing. A generally big data analysis is narrowed down to the single data format.
- **Feature Analysis:** The current explosion of multimedia data increases the complications of data analysis as well. Feature extraction is connected to the gap between low-level multimedia characteristics into its high-level semantic content. It is time-consuming task to extract the features from massive datasets, and for that, the whole process is parallelized and shared among numerous systems. Recently, the fast feature extraction method is studied [27], and compared the three big data techniques for multimedia feature extraction such as Apache Hadoop, Apache Storm, and Apache Spark. Schuller et al. [23] studied how to extract the features directly from compressed audio data.

- **Deep learning Algorithm:** Many researchers have been motivated by the popular Deep Learning toolboxes to extract large-scale features using deep learning algorithms. Deep learning has mainly focused on unsupervised feature learning and based on deep learning, a very less amount of work has been carried out on multimodal features. An audiovisual speech classification framework using three learning techniques are fusion-based method, a cross-modality, and shared representation learning method. In the mid-2000s, feature reduction techniques were proposed for large scale real time multimedia data. Online feature selection (OFS) in which an online learner is only allowed to maintain a classifier involved only a small and fixed number of features. The group and nonlinear feature selection methods are based on Adaptive feature scaling to increase the performance and speed of the training process.
- **Machine Learning:** Machine learning is the procedure of improving the performance of computer programs by learning the data automatically through experience. The main purpose of machine learning is to learn a specific work whose class tag is unknown. The supervised and unsupervised learning are the classifications of machine learning. In unsupervised learning, there is no label related to each data instance input. The Supervised learning use an algorithm to learn the mapping function from the input to the output.

4.5 Storage and Retrieval of Multimedia Data

The multimedia big data management and recovery are carried out with the help of annotation due to the unstructured and heterogeneity of data. Annotation [12] is categorized as the manual and automatic annotation. The manual annotation [28] is done by users, source providers, and tools. The automatic annotation is carried out by machine learning algorithms. The automatic annotations are more interesting as compared to manual annotation due to the endlessly growing data. The main problem of automatic annotation is a semantic gap. From the multimedia text documents, the semantic data are extracted by using Latent Dirichlet Modeling (LDM). Currently, the deep learning techniques have been used widely to extract annotations for videos and pictures. Generally, the Multimedia Database Management System (MMDBMS) consists of multimedia data and their relationship, which is different from traditional relational database management system. The characteristics of the multimedia database are storage, constraints on spatial and temporal, presentation of data, retrieval, etc.

The main requirements of the multimedia database are traditional database capabilities, data modeling, storage management, retrieval, integration of media, interface, and interactivity, and performance. The multimedia database management system requires to satisfy the following requirements to perform the manipulation and storage efficiency:

- **Data modeling for multimedia.** Even though the various traditional database modeling is available such as relational modeling, semantic, and network modeling, only few modeling methods proposed for multimedia databases due to the unstructured nature of multimedia data. For each type of media, the multimedia data needs an object-oriented data model. The modeling system for the multimedia document, which combines the technologies such as Object-Oriented Database Management System, Natural Language Processing (NLP), etc., to excerpt the vital information, structure the input documents and offers semantic recovery. The data modeling is mainly used to extract/retrieve the information.
- **High volume storage management.** The storage management of multimedia characterized by significant volume and variety which need a hierarchical structure. The hierarchical storage of multimedia big data increases the storage size and decreases the performance.
- **Query support and retrieval capabilities.** Multimedia data needs different queries such as content and keyword. The multimedia query typically does not return an exact match; it returns a result which contains an object similar to the query object. The multimedia consists of different media types, which require consistent ranking and pruning approaches.
- **Media Integration, configuration, and presentation.** The integration and configuration play an essential role; once unstructured data are converted into a structured data format. It ensures the truthfulness and individuality of multimedia data. The multimedia big data require an efficient and effective presentation to reduce excessive computation storage.
- **Performance.** The performance is an essential parameter of multimedia big data, such as competence, consistency, processing of data on real-time and execution, Quality of Service (QoS), Quality of Experience (QoE), and guaranteed multimedia presentation. These performances are achieved with the help of cloud computing and distributed processing.
- **Multimedia Indexing.** Generally, the traditional RDBMS is not appropriate for multimedia big data because of unstructured data format. This problem solved with the help of indexing approaches. The indexing approaches have been proposed to manage the different data types and queries. Artificial Intelligence (AI) and non-artificial intelligence are the types of indexing approaches.

4.6 Assessment

Advancements of information technologies and MEMS (Micro Electro Mechanical Sensor) technologies and its extensive growth in numerous areas resulted in an enormous amount of different data such as videos, audios, and text data. Due to the rapid development of multimedia data and services, it is vital to provide the Quality of Experience (QoE) to the users. Either the subjective or objective analysis is carried out to test the quality of the videos. The subjective analysis is carried out in a test center which needs more human resource and expense. Generally, the subjective

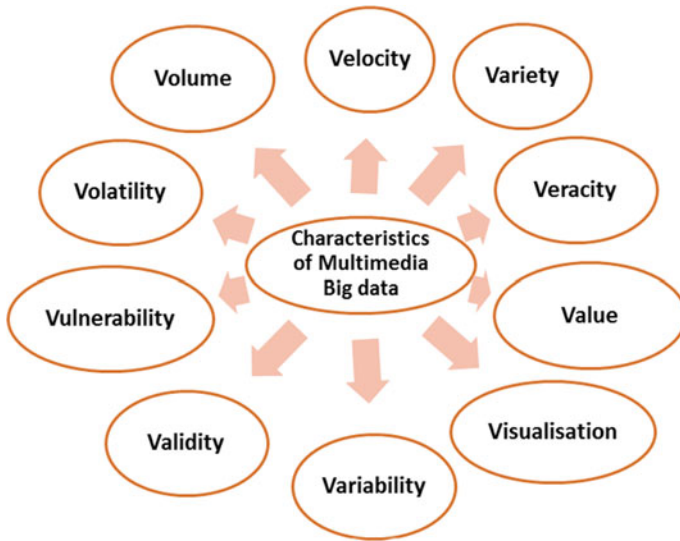

Fig. 5 Characteristics of multimedia big data

assessment is not carried out for real-time estimation. The objective test depends on the standard of Human Visual System (HVS). The objective assessment analysis is based on subjective assessment test parameters.

4.7 Computing

From the enormous amount of multimedia data, it is a challenging task to organize and process the multimedia big data. Multimedia big data computing is a novel paradigm; the data analytics is performed by combining large-scale computation with mathematical models.

5 Characteristics of Multimedia Big Data

A multimedia is a group of enormous and complicated datasets. Figure 5 shows the characteristics of multimedia big data. Figure 6 shows the five V's of multimedia big data. The following characteristics can describe it,

Volume: In big data, the volume defined as the vast volumes of data generated through the internet of things, portals, internet, etc. According to Worldometers 2016, above 7.4 billion people (Worldometers 2016) are in the world, and almost 2 billion peoples are linked to the internet, and remaining individual people are using various

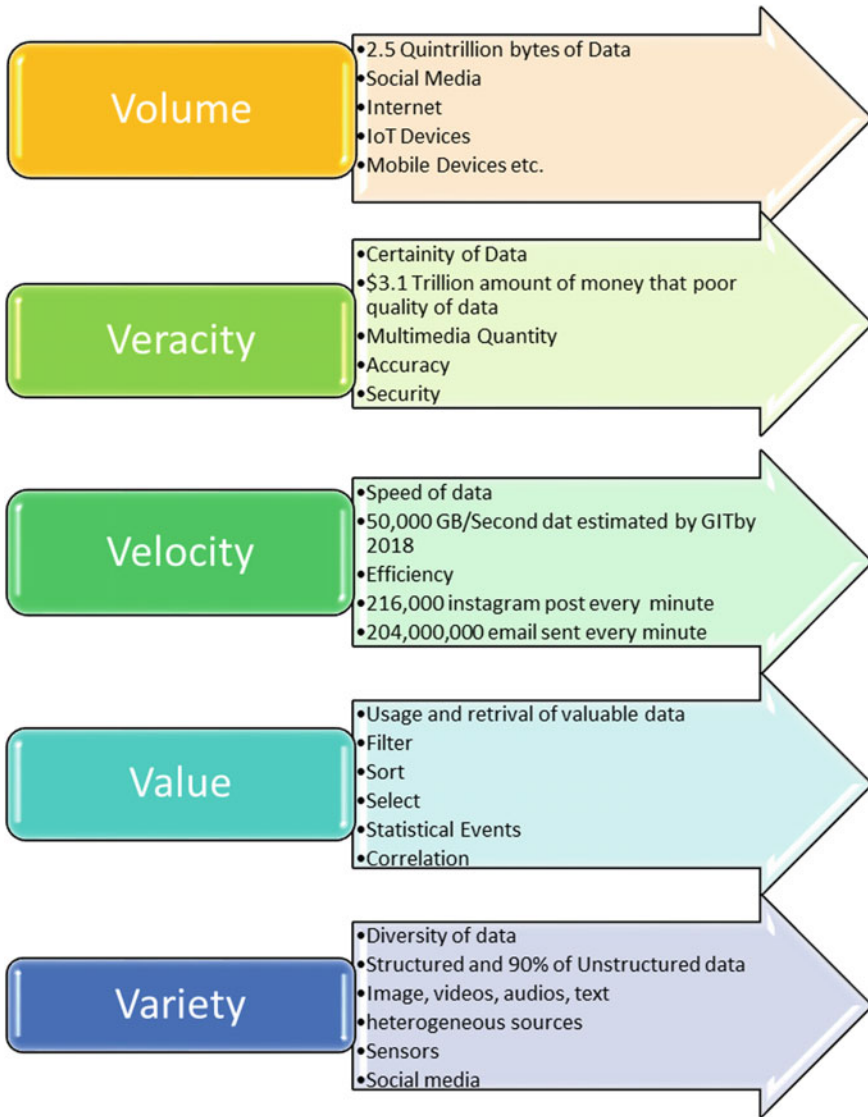

Fig. 6 Five V's of multimedia big data

portable handheld devices, i.e., mobile devices. As a result of this technological development, each product produces huge volume of multimedia data through the growth of Internet technology and the use of various devices. Especially, remote sensors embedded in the devices produce the heterogeneous data continuously either in a structured or unstructured format. In the near future, the exponential growth of multimedia data exceed yottabytes (10^{24}). For example, more than one billion users (YouTube.com 2016) are daily uploading videos over 300 h/min on YouTube. The Facebook comprises more than 1.4 billion users, 25 trillion posts as on 2016 (StatisticsBrain 2016), and a total of 74 million Facebook pages. In 2016, 6.2 billion gigabytes of global mobile traffic is estimated per month. According to the report of Digital universe study of International Data and EMC Corporation, the data has been generating tremendously, i.e., 800 EB in 2009–1.8 ZB in 2011, and in near future, data grow 40 times (40ZB) greater in 2020. It is very challenging to handle such amount of multimedia big data [26] concerning gathering, storage, analyzing, preprocessing, sharing, and visualization.

Velocity: The term velocity denotes the rate at which data has been generated, i.e., how fast the data is coming in. Hendrickson et al. [29], reports that information proliferates by one order of scale every 5 years. Every day, 5 billion users browse the internet, tweet, upload, and send both multimedia and standard data. The people generates 58 million tweets and 2.1 billion queries in tweeter per day. The number of users using YouTube increased to 40% since March 2014. Almost 50% of Facebook account holders log into Facebook account every day. Every minute, about 2 million searches and queries in Google (Google.com 2016) and Google processed 25 PB every day. The efficient management tools and techniques are required to cope up with the speed of multimedia big data.

Variety: The term variety refers to the diversity of data [29]. Examples of variety are emails, voicemails, video message, ECG reading, audio recording, etc. In the age of multimedia big data, the data gathered from heterogeneous sources are represented by either images or videos. It contains more information and knowledge. Generally, sources generate structured and unstructured data. Unstructured data does not have any fixed format which is very difficult to process. The similar formats and predefined lengths are referred to as structured data. The unstructured data can be processed with the help of Hadoop; the clustering method used to process the unstructured data in a short interval of time. The unstructured multimedia big data brings more challenges for analyzing, preprocessing, and extracting the valuable data.

Veracity: In multimedia big data, the term veracity denotes the uncertainty of data, noise, and deviation in data. It is very challenging issues in multimedia big data to ensure the precision of data which make it as difficult to determine how much data can be reliable.

Value: Value is the most critical element in multimedia big data. It denotes the usage and retrieval of the valuable information from these huge volumes and diversity of data. For the analysis of data, it is essential to filter, sort, and select data.

The other essential V's of multimedia big data is as follows:

- **Visualization:** The essential challenging characteristics of multimedia big data are in what way the data is visualized. The technical challenges confronted by tools available for visualization is due to the limitations of memory, functionality, expandability, and response time. It is not possible to plot a billion of data points using traditional graphs. The multimedia big data need different methods of representing data such as data clustering, parallel coordinates, circular network diagrams, sunbursts, etc.
- **Vulnerability:** Vulnerability refers to security concerns about multimedia big data.
- **Validity:** Validity denotes the correctness of the data for its envisioned use.
- **Variability:** It refers to the number of inconsistencies in the data, as well as, the speed at which multimedia data loaded into your database.

6 Multimedia Big Data Challenges and Opportunities

With the proliferation of IoT, the world has marched into multimedia big data. The development of multimedia big data provides a lot of challenges as well as countless chances for the betterment of IoT applications.

6.1 Acquisition Challenges

Many different types of multimedia are videos, audios, speech, online streaming videos, documents, graphics, geospatial data, 3D virtual worlds, etc. Multimedia big data is unstructured data, which have more complexity in an analysis as compared to typical big data. The unstructured data can be easily understandable by users which proliferate regarding quantity and quality. It is difficult to understand by the machines. These are the main challenges of multimedia big data acquisition. Some of the papers addressed these issues are as follows: the representation and modeling of multimedia big data is a very challenging task. Most of the studies focused on graph structure instead of video structure. Generally, the large-scale multimedia big data is acquired from the source, which contains the data in the form of incompleteness, uncertainty, communication errors, also affect from malicious attack, data corruptions mainly ignored the hidden video content and different levels of quality.

In BigKE method presents the knowledge framework to handles disjointed knowledge and E-learning methods which receives the data from heterogeneous sources. The streams feature is derived from spatial and temporal information. Wu et al. [30] presents a tag assignments stream clustering for dynamic unstructured data, which is modeled as a stream to describe the properties and interest of users. Hu et al. [11] proposed a model to manage the multimedia big data using semantic link network, which creates the relationship among different multimedia resources.

Table 2 Existing methods of acquisition process

Methods	Objectives	Limitations
BigKE [30]	Knowledge framework to handles disjointed knowledge exhibiting and E-learning methods from numerous heterogeneous sources	Not addressed IoT
Semantic link network model [11]	Manage the multimedia data using semantics	Not addressed issues on IoT
Wang [35], Pouyanfar et al. [44]	Addressed the review of multimedia big data	Not addressed issues on IoT
Kumari et al. [31]	Addressed the taxonomy and multimedia big data for IoT	Focused on IoT

Multimedia data acquisition for IoT application is categorized as three parts, namely, data gathering, compression, and representation [31]. Table 2 shows the pros and cons of existing acquisition process.

In context of IoT, the multimedia data is often collected from sensors. The data collection has been carried out from several areas such as forecasting health status of patient, wireless networks, Internet of Multimedia Things (IoMT), Healthcare I, industrial IoT (Health-IIoT) and personal devices. The multimedia big data collected from the IoT devices are heterogeneous in nature. The main limitations of the existing methods are each method has different views and categories. While designing a new method for data acquisition, the following factors are considered such as unstructured data, heterogeneous sources, multimodal, dynamic evolution, user's interest, spatial and temporal information, semantics, and geographically distributed data.

6.2 Compressing Challenges

The multimedia big data is a massive size of data; it must be compressed before further processing and storage.

The compression of multimedia big data brings more challenges as compared to traditional datasets and big data techniques. Due to the limited storage and processing/computational capability, it needs to be compressed effectively with the help of signal processing and transformation.

Many challenges arise while compressing multimedia big data as follows:

- Multimedia big data is difficult to handle because of unstructured data;
- Due to the large volume of data, it is challenging to compress at a fast speed;
- Data loss is very high due to diverse sources.

The traditional big data reduction approaches for compression are wavelet transform and compressive sensing. Duan et al. [32] proposed the compression technique

based on feature descriptor to attain large reduction ratio which depends on different coding approaches. Bu et al. [22] proposed a deep learning-based feature extraction context to extract the multilevel three-dimensional shape feature extraction. Xu et al. [20] proposed a latent intact space learning to acquire abundant data information by merging multiple views. Herrera et al. [33] proposed an architecture to handle the data from various multimedia streaming stations such as TV and radio stations to perform gather, process, analyze, and visualize data. The approaches mentioned above is mainly focused on high-level integrated features in multiple views. The effective description techniques are needed to extract high features. Most of the existing approaches are not focused on the application of IoT. Table 3 shows the pros and cons of existing methods of data reduction and collection.

6.3 Storage Challenges

Big volume of multimedia big data being is created continuously, and it is essential to store the large volume of data after compression. The size of multimedia big data is unlimited and has a variety of media types. With the massive evolution of multimedia big data, the quality and amount of unstructured data bring more challenges to store data as compared to typical big data. The storage system of typical big data is based on the NoSQL. In multimedia big data scenario, it is impossible to store all real-time streaming multimedia data. The limitation of existing storage methods is given in Table 4.

The challenges of multimedia big data storage addressed in the new design regarding feasibility and cost. Dede et al. [34] present a pipeline processing to combine the NoSQL storage with big data processing platform (MapReduce). Wang et al. [35] presented hybrid stream big data analytic models for multimedia big data to addresses the data video analysis which contains data preprocessing, classification, recognition, and big data overload reduction. Table 3 shows the limitations of existing storage methods.

Liu et al. [20] present a hashing algorithm based on deep learning and shallow learning to efficiently store multimedia data, indexing, and retrieval. NoSQL-based approach is introduced to manage real-time embedded database efficiently. It is mainly designed to distribute data storage for an enormous amount of data needs, which takes advantage of scaling. The concept of integrating the IP Multimedia Subsystem (IMS) with the Hadoop system increases the performance, scalable distributed storage, and computing system of IP multimedia subsystem service resources. While designing the storage system for multimedia big data, the following features should be considered to increase the performance and distributed storage. The boundaries of IoT and cloud computing should be considered.

Table 3 Existing methods of data collection and reduction

Category	Survey	Area of Interest	Pros	Cons
Multimedia data collection	Gao et al. [39]	Machine learning feature analysis	Outline of High-dimensional multimedia big data and machine learning techniques	Not focused on multimedia big data and its technical challenges on IoT
	Hu et al. [11]	Retrieval of video	An overview on video indexing and retrieval	<ul style="list-style-type: none"> • Limited to single multimedia data type • Lack of multimedia big data challenges
	Wang et al. [39]	Smart grid	A general overview on multimedia wireless sensor networks and its application in smart grid	Limited to multimedia big data analytics
	Madan et al. [45]	To predict health status of the patient	Low costs for providers	Not addressed wireless networks issues
	LUSTER [46], Hossain et al. [47]	<ul style="list-style-type: none"> • Environmental monitoring using WSN • Data collected from Internet 	<ul style="list-style-type: none"> • Data reliability, efficient scalability • Distributed and fault tolerant storage 	Prone to Security breaches
	Duang et al. [32]	<ul style="list-style-type: none"> • Feature descriptor based on multimedia coding approaches 	<ul style="list-style-type: none"> • High compression ratio 	Not focused on multimedia data on IoT

Table 4 Existing methods of data storage

Multimedia big data storage	Survey	Methodology	Limitation
	Dede et al. [34]	Combining NoSQL with Big data platform	Need to consider IoT and Cloud Computing to increase the performance and storage
	Wang et al. [35]	<ul style="list-style-type: none"> • Addressed Video data analysis • High stream big data analytics 	
	Liu et al. [20]	<ul style="list-style-type: none"> • Hashing algorithm depend on deep and shallow learning 	

6.4 Processing Challenges

The fundamental task of the processing is to extract useful information for further activities. The multimedia big data are generated from real-time applications. It is essential to process the multimedia big data effectively with limited processing time. It is essential to address the challenges of multimedia significant data processing is as follows:

- The larger volume of multimedia big data is generated continuously from the heterogeneous sources. It needs to be processed at high speed to store data efficiently in real-time.
- To handle the enormous amount of multimedia data, it needs to develop the automated and intelligent analytical technique to extract knowledge from heterogeneous data.
- To process the multimedia big data, it needs parallel/distributed, and real-time streaming algorithms.
- Need large-scale computation, storage, communication resources, and networking to process a huge volume of multimedia big data which should be optimized.

The sparsity, spatial-temporal information, and heterogeneity should be considered in future approaches for multimedia big data. The bottlenecks of processing such as communication, storage, and computational should be reduced.

6.5 Understanding Challenges

With the massive evolution of multimedia big data, there is a semantic gap between low-level and high-level semantics features. Multimedia big data is challenging to understand by a device; particularly, certain multimedia big data changes with respect to time and space. In order to understand the semantic gap in the multimedia big data, the efficient cross-media and multimodal systematic tools, and intelligent analytical methods are needed to overcome the limitations. Schuhmacher et al. [31] present a

knowledge graph which consists of objects, concepts, and relationships; to extract the knowledge associations from different heterogeneous data. The concept and entities reproduce the real-world concepts. The pattern matching methodologies is used to extract the information from open source before constructing the knowledge graph. The knowledge graph is used in different applications, such as big data analytics, deep learning, to search semantic data, etc. Extensive research is needed to construct the knowledge graph automatically to handle the huge scale of data. Recently, research works are going on the structured and semi-structured text data. More research is required on the unstructured knowledge graph to handle the large volume of multimedia big data.

6.6 Computing Challenges

The multimedia big data is generated from the real-time environment. It is generating continuously by more number of heterogeneous sources, which requires to process uninterruptedly to store the data efficiently and time restrictions. Multimedia big data consists of a wide variety of data and transient in nature. As a result, it is essential to design the concurrent and instantaneous online streaming processing for scrutiny of multimedia data. To perform computation on large-scale data, it is necessary to optimize storage, communication resources, and processing. Due to the development of communication technology, the multimedia big data travels through the network at very high speed; it brings the challenges of GPU computing. The cloud-based system presented to harvest data from multimedia big data in the global camera networks. In this method, it receives multimedia data from numerous devices, and it can be evaluated instantaneously by an application programming interface. The storage and computing of multimedia big data problem can be addressed by cloud computing technology.

Sadiq et al. [36] addressed the several challenges of multimedia big data received from crowded heterogeneous sources. The author presents a framework for spatial multimedia big data and various multimedia sources. It also handled the spatial queries related to multimedia big data in real-time. Cevher et al. [37] addressed the bottlenecks in big data such as computational, storage, and communications. It also

shows that advances in convex optimization algorithms propose several unconventional computational choices. The synchronization problem in multimedia big data is addressed to exploit the therapy recorder, which can implement the two-tier synchronization process. It creates the multimedia synchronized therapy session file and separates the complex media files. Garcia et al. [38] present a pipeline media concept and Platform as a Service (PaaS) scheme. Zhang et al. [28] presents a method to efficient precision recommendation method to recover the particular image from the large size image database. The author presents three different types of content-based imageretrieval, based on the content comparison the relevant image is recovered from the image database. The authors have been analysed the platform to facilitate the public cultural services based on cloud computing and Hadoop system. The fusion of cloud computing and big data technology need to be considered to reduce computation time and improve data scalability. The data traffic can be classified based on the local and structural features to process the data in real-time.

6.7 Security and Privacy Challenges

The multimedia big data consists of different datasets, which include private/personal videos or sensitive videos [27]. With the explosion of videos, the multimedia big data must be governed in complete security. It is challenging and essential to trace and protect the multimedia big data. In order to manage and accesses the multimedia big data securely, it is essential to study the implementation of a privacy policy. In the context of IoT devices, the security of multimedia big data provides confidentiality, integrity, and availability. Due to the huge volume and heterogeneous nature of data, the security brings more challenges to deal with multimedia big data in IoT. In case of centralized data, the single point of failure reveals the user's information which violates the laws. An outset of data mining in the real world dogged to privacy issue. The encryption techniques are used to secure the confidentiality of multimedia big data. At present, the methodologies/technologies available ensure only the privacy of the static data. The protection of dynamic dataset is a challenging task.

6.8 Assessment Challenges

The Quality of Experience (QoE) plays a significant part in multimedia big data for video applications. Some of the challenges of multimedia big data assessment are as follows:

- It is a tedious task to measure and quantify user experience levels.
- In real time, it is complicated to keep track of multimedia big data applications.
- In what way to correlate Quality of Service (QoS) and QoE metrics effectively?
- In what way to obtain a standard for users?

- How efficiently analyses the customers' experience?
- In what way quickly and accurately measure the QoE under various standards?

Wang et al. [39] present the importance of monitoring and analyzing the network traffic to improve the customer experience and improving resource allocation of networks. Liu et al. [20] present the methodology to monitor and analyze the big data traffic with the help of Hadoop. Hadoop is mainly developed for batch processing, later on, used for large-scale data processing. It is a license-free Java-based distributed computing platform for big data. Google developed Hadoop for big data applications. In Hadoop, the Java language is used to write MapReduce code. The features of Hadoop are cost effective, high efficiency, scalability, tolerate the fault, and distributed concurrency computing. The significant primary challenge of Hadoop is tough to adapt it for network measurement. Recently, many research works have been carried out on QoE problems. Adaboost model presented to achieve higher accuracy which shows the relationship between the significances of the IPTV set-up box and QoE. An user-centric QoE prediction methodology depends on various machine learning algorithms such as artificial neural networks, decision tree, Gaussian Naïve Bayes classifiers, and vector regression tool. Sun et al. [4] present a decision tree video to model datasets, which achieves good service and enhance the users QoE. The main characteristics of this model provide the association between users QoE and alarming data for IPTV. The cross-layer prediction method was proposed to estimate the mobile video quality without any reference model. Recently, much research has been carried out on user-centric analysis and a likelihood of QoE based on a machine learning algorithm.

7 Opportunities

Despite all the challenges faced by the multimedia big data, it still offers considerable opportunities to the Internet of Multimedia Things (IoMT) to advance the facilities and applications through the efficient use of multimedia big data. With the proliferation of MEMS technologies, the IoT is well thought-out as one of the most transitions in today's technology. IoT offers more opportunities for multimedia big data analytics. Some examples of multimedia big data computing for IoT applications are as follows:

E-Commerce In this era, the growth of multimedia big data is very high as compared to traditional data. To process the large quantity of data in real time, the multimedia IoT big data analytics provides well-designed tools for decision-making. The integration of multimedia big data with IoT provides new challenges and openings to construct a smart environment.

Social Media Analytics collects the data from social media such as Facebook, Twitter, Google Plus, blogs, Wikipedia, etc., to analyses/statistics such data to gather the knowledge. Most of the E-commerce vendors are gathering the social media

analytics to gain business values, increase the sales and profits, customer satisfaction, build companies reputation, and create brand awareness among people.

Smart Cities The development of multimedia big data and evolution of IoT technologies have played a significant role in the initiatives of smart cities. The integration of IoT and multimedia big data is a promising new research area that brought more interesting challenges and opportunities for attaining the goal of future smart cities. IoT plays an important source for collecting a large amount of multimedia big data, which needs high-speed processing, analysis, and transmission. Tanwar et al. [40, 41] proposed an advanced security alert system architecture for smart home using pyroelectric infrared and raspberry pi module.

Healthcare: Big data has a huge potential to alter the healthcare industry. The smart healthcare devices produce a huge amount of information such as ECG, temperature monitors, sugar level, etc. The healthcare devices monitor real-time health data of patient, which reduces the overall cost for the prevention and management of illnesses. From the analysis of health data, the doctor could diagnose and detect diseases at an early stage. Due to the high-speed access to the internet, many people have started to utilize mobile applications to manage their health problems. These mobile applications and smart devices are integrated and act as a Medical Internet of Thing (MIoT).

The proper use of multimedia big data gathered from IoT increase economics, productivity and bring new visions to the world. Based on a literature review, the challenges are identified for multimedia big data analytics in Internet of Things (IoT).

8 Future Research Directions

Many of the organizations have widely acknowledged multimedia big data computing for IoT applications. Still, multimedia big data for IoT is in primary stages. Many current challenges have been not addressed. This section gives numerous challenges and its future research directions of multimedia big data computing for IoT applications.

8.1 Infrastructure

In this era, the amount of data generated from the IoT devices exceeds the computer resources. To analyze the multimedia big data, the manufacturers have to produce a high-volume solid hard disk drive to handle a massive volume of data. The solid disk drive replaced the conventional hard disk storage system. In the near future, a powerful processor is needed to process an enormous amount of multimedia big data. The diversity of real-time multimedia big data such as 3D graphics, audios, and videos are processed by more efficient Central Processing Unit (CPU) virtualization and I/O virtualization needed, which reduces cloud computing cost. As already mentioned

that the primary source of generating multimedia data from the internet is IoT, which would need large data warehouses. Hadoop and Spark techniques would be used further to explore the data locality and transfer huge volume of big data to computing units over traditional High-Performance Computing (HPC).

8.2 Data Security and Privacy

Data security and privacy play a significant concern in multimedia big data. Still, most of the enterprises do not use the cloud to store their multimedia big data due to the nonexistence of data visibility and privacy in this new infrastructure. As mentioned earlier, data security and privacy have been a significant problem in the development of technologies and mobile devices (MIoT). The security storage and management of big data, privacy on data mining and analysis, access control are the possible mechanisms for multimedia big data. It does not increase the computational and processing cost. It should balance between access control and processing ease. The efficient security mechanism such as encryption of multimedia data is required to secure the multimedia big data. The privacy plays an significant issue in data mining. The privacy of data is achieved by encryption, anonymity, and temporary identification. Another security issue related to multimedia big data associated with IoT is the heterogeneity sources used and the nature of different types of data generated. The authentication of heterogeneous devices could be carried out by assigning a unique identification to the respective device. The architecture of heterogeneous IoT has increased the security risks to security professionals. Subsequently, any attack in IoT architecture compromises the security of the system and cutoff interconnected devices. The traditional security algorithm is not appropriate for IoT devices due to a dynamic observation of data. The security problems encountered by IoT big data are as follows: (a) dynamic updates—challenging to keep system updates, (b) identifying illegitimate traffic patterns among legitimate ones, (c) interoperability, (d) and protocol convergence—the application of Ipv4 security rules are not suitable for currently compatible IPv6.

Currently, these challenges are not addressed to accomplish the privacy and security of connected IoT devices. The subsequent strategies can overwhelm these difficulties such as (1) APIs is essential to evade compatibility and dependability problems. (2) IoT devices is well guarded while interconnecting with peers. (3) Protected devices with best-hardcoded security practices to resist against threats.

8.3 Data Mining

Data mining plays a significant part in multimedia big data, which is used to extract the interesting data for multimedia datasets. Multimedia datasets consist of structured and unstructured data such as videos, audio, images, speech, text, etc. The multimedia

data mining is further categorized as static and dynamic media. Examples of static media are text and images; dynamic media is audio and videos. The multimedia data mining mentions that the analysis of a massive amount of multimedia big data gathered from IoT devices to excerpt the useful information pattern depend on their statistical relationship.

Data mining methods offer solutions for multimedia big data to generalize for new data. IoT brought the challenges of data extraction. The main challenges related to data mining and processing are knowledge discovery, processing, and data. A large amount of big data faces the challenges due to volume, openness, exactness, and heterogeneity regarding data sources and data type. The big data sets are more irregularities and uncertainties in nature, which require additional preprocessing such as cleansing, reduction, and transmission. Recently, researchers have presented programming models based on concurrent, and serial processing and diverse algorithms are proposed to reduce the response time of query on big data. Researchers have an opportunity to address the bottlenecks of data mining in big data IoT.

8.4 Visualization

In big data analytics with IoT systems, the visualization plays a vital role in dealing with a large amount of data are generated. Visualization is difficult to process because of a large amount of data and its different dimensions. It is necessary to work faultlessly in big data analytics and visualization to obtain better results from IoT applications. Visualization is a difficult task in big data because of heterogeneous and various types of data such as structured, unstructured and semi-structured data. Designing visualization for IoT big data is an arduous task. Wang et al. [42] addressed the challenges and technology progress of visualization and big data. The visualization software is used to visualize the fine-grained dimensions based on the concept of the locality reference as well as the probability of identifying the correlations, outliers, and patterns. The concurrency is a thought-provoking task in visualization to manage the IoT big data. Most of the visualization tools used for IoT produced deprived performance regarding scalability, functionality, and response time. Gorodov et al. [43] addressed real-time analytics for IoT architecture issues of data visualization concerning the application of big data such as visual noise, information loss, great image observation, high-performance requirements due to the dynamic generation of data in an IoT environment.

8.5 Cloud Computing

The advancement of visualization technologies has motivated the development of cloud computing technologies. The cloud computing technologies characterized by virtual computers are constructed on top of the computing infrastructure. The main

limitations of cloud computing are cost of the massive amount of data storage, control over the distributed environment, security, privacy, and transfer. All these limitations is considered for future research directions.

8.6 Integration

Data integration denotes that the different formats of data can be viewed as uniform. Integration offers a single point of view of the data, which is gathered from heterogeneous sources. Multimedia big data are generated from different sources continuously. The produced data can be classified into three groups, namely, (1) structured, (2) unstructured, and (3) semi-structured. It extracts the information from different datasets. It is a challenging task to integrate different data types, and overlapping of the same data increases the scalability, performance, and enable real-time data access. These challenges related to the integration of data should be addressed in the near future.

8.7 Multimedia Deep Learning

The application of deep learning in computer vision, NLP, speech processing, etc., are growing faster as compared to current research in deep learning on multimedia big data analysis. The deep learning analysis of multimedia big data is yet in its initial stage of development. The different modularity of data needs to be analyzed using multimodal deep learning techniques. The future deep learning research is mainly focused on dealing with heterogeneous sources, high-dimensional, and un-named multimedia data. As compared to the traditional machine learning approaches, the computational efficiency of deep learning is remains a big challenge; because of the massive amount of resources and more training time is needed. The efficiency of deep learning techniques can be increased by using clusters of GPU. Lacey et al. [37] suggested the use of Field-Programmable Gate Arrays (FPGA) on deep learning, which provides an optimization, the large degree of parallelism and reduces the power consumption as compared to the GPU.

9 Summary

This chapter has presented the sophisticated approaches developed for multimedia big data analytics. The emergence of multimedia big data opens opportunities and draws more attention to researchers. First, introduce the general background of big data, challenges, and its application in multimedia big data. This chapter provides an extensive overview of the multimedia big data challenges, the impact of multimedia

big data in IoT, and characteristics have been discussed in 10 V's perspective. The different phases of multimedia big data such as data generation and acquisition, data representation, compression, processing and analysis, storage and retrieval, assessment, and computing have been discussed. Further, a comprehensive and organized framework has been discussed for each stage such as background, technical challenges, and review the recent updates in the area of multimedia big data. In addition, a list of opportunities for the multimedia big data has also been provided. In spite of all the challenges faced by the multimedia big data, it still offers huge opportunities to the Internet of Multimedia Things (IoMT) to advance the services and applications through the efficient use of multimedia big data. Many organizations acknowledged the development of multimedia big data for IoT applications. Multimedia big data for IoT is in the primary stage. These discussions aim to offer a broad overview, and perspective to make the significant advances in multimedia big data for IoT that meets futures requirement.

References

1. R. John et al., Riding the multimedia big data wave, in *Proceedings of the 36th International ACM SIGIR Conference on Research and Development in Information Retrieval* (ACM, Dublin, Ireland) pp. 1–2 (2013)
2. L. Mearian, By 2020, there will be 5,200 GB of data for every person on the Earth, <http://www.computerworld.com/article/2493701/data-center/by-2020-there-will-be-5-200-gb-of-datafor-every-person-on-earth.html>. Accessed 5 Apr 2016
3. E. Adler. Social media engagement: the surprising facts about how much time people spend on the major social networks (2016), <http://www.businessinsider.com/social-media-engagement-statistics-2013-12>
4. Mei-Ling Shyu, Shu-Ching Chen, Qibin Sun, Yu. Heather, Overview and future trends of multimedia research for content access and distribution. *Int. J. Semant. Comput.* **1**(1), 29–66 (2007)
5. J. Gantz, D. Reinsel, Extracting value from chaos. IDC iView 1–12 (2011)
6. K. Cukier, Data, data everywhere: a special report on managing information (2011)
7. Lohr S, The age of big data. *N. Y. Times* 11 (2012)
8. V. Mayer-Schonberger, K. Cukier, Big data: a revolution that will transform how we live, work, and think. EamonDolan/Houghton Mifflin Harcourt (2013)
9. P. Zikopoulos, C. Eaton et al., Understanding big data: analytics for enterprise-class Hadoop and streaming data. McGraw-Hill Osborne Media (2011)
10. E. Meijer, The world according to LINQ. *Commun. ACM.* **54**(10), 45–51 (2011)
11. C. Hu, Z. Xu, Y. Liu, L. Mei, L. Chen, X. Luo, Semantic link network-based model for organizing multimedia big data. *IEEE Trans. Emerg. Top. Comput.* **2**(3), 376–387 (2014)
12. M. Beyer, Gartner says solving big data challenge involves more than just managing volumes of data. Gartner, <http://www.gartner.com/it/page.jsp>
13. R. Cattell, Scalable SQL and NoSQL data stores. *ACM SIGMOD Rec.* **39**(4), 12–27 (2011)
14. O.R. Team, Big data now: current perspectives from O'Reilly radar. O'Reilly Media (2011)
15. A. Labrinidis, H.V. Jagadish, Challenges and opportunities with big data. *Proc. VLDB Endow.* **5**(12), 2032–2033 (2012)
16. R.E. Wilson, S.D. Gosling, L.T. Graham, A review of Facebook research in the social sciences. *Perspect. Psychol. Sci.* **7**(3), 203–220 (2012)

17. Z. Tufekci, Big questions for social media big data: representativeness, validity and other methodological pitfalls, in *Proceedings of the Eighth International Conference on Weblogs and Social Media* (Michigan, USA, 2014) pp. 505–514
18. D. Agrawal, P. Bernstein, E. Bertino, S. Davidson, U. Dayal, M. Franklin, J. Gehrke, L. Haas, A. Halevy, J. Han et al., Challenges and opportunities with big data. A community white paper developed by leading researches across the United States (2012)
19. N.D. Lane, E. Miluzzo, L. Hong, D. Peebles, T. Choudhury, A.T. Campbell, A survey of mobile phone sensing. *IEEE Commun. Mag.* **48**(9), 140–150 (2010)
20. Xu Zheng, Yunhuai Liu, Lin Mei, Hu Chuanping, Lan Chen, Semantic-based representing and organizing surveillance big data using video structural description technology. *J. Syst. Softw.* **102**, 217–225 (2015)
21. Mei-Ling Shyu, Zongxing Xie, Min Chen, Shu-Ching Chen, Video semantic event/concept detection using a subspace-based multimedia data mining framework. *IEEE Trans. Multimedia* **10**(2), 252–259 (2008)
22. A. Kumari, S. Tanwar, S. Tyagi, N. Kumar, Fog computing for healthcare 4.0 environment: opportunities and challenges, *Comput. Electr. Eng.* **72**, 1–13 (2018)
23. Gerald Schuller, Matthias Gruhne, Tanja Friedric, Fast audio feature extraction from compressed audio data. *IEEE J. Select. Top. Sign. Process.* **5**(6), 1262–1271 (2011)
24. K.R. Malik, T. Ahmad, M. Farhan, M. Aslam, S. Jabbar, S. Khalid, M. Kim, Big-data: transformation from heterogeneous data to semantically-enriched simplified data. *Multimed. Tools Appl.* **75**(20), 12727–12747 (2016)
25. Y. Jia, E. Shelhamer, J. Donahue, S. Karayev, J. Long, R. Girshick, S. Guadarrama, T. Darrell, Cafe: convolutional architecture for fast feature embedding, in *Proceedings of the ACM International Conference on Multimedia* (2014), pp. 675–678
26. N. Khan, I. Yaqoob, I.A.T. Hashem, Z. Inayat, W. Kamaleldin, M. Ali, M. Alam, M. Shiraz, A. Gani, Big data: survey, technologies, opportunities, and challenges. *Sci. World J.* **18** (2014)
27. David Mera, Michal Batko, Pavel Zezula, Speeding up the multimedia feature extraction: a comparative study on the big data approach. *Multimed. Tools Appl.* **76**(5), 7497–7517 (2017)
28. G. Zhang, Y. Yang, X. Zhai, W. Huang, J. Wang, Public cultural big data analysis platform, in *Proceedings of 2016 IEEE Second International Conference on Multimedia Big Data (BigMM)* (Taipei, Taiwan, 2016) pp. 398–403
29. S. Hendrickson, Getting started with Hadoop with Amazon’s Elastic MapReduce (2010), <https://www.slideshare.net/DrSkiippy27/amazon-elastic-map-reduce-getting-started-with-hadoop>
30. X. Wu, H. Chen, G. Wu, J. Liu, Q. Zheng, X. He, A. Zhou, Z. Zhao, B. Wei, M. Gao, Y. Li, Q. Zhang, S. Zhang, R. Lu, N. Zhang, Knowledge engineering with big data. *IEEE Intell. Syst.* **30**(5), 46–55 (2015)
31. M. Schuhmacher, S.P. Ponzetto, Knowledge-based graph document modeling, in *Proceedings of 7th ACM International Conference on Web Search and Data Mining (WSDM’14)* (New York, NY, 2014) pp. 543–552
32. L.-Y. Duan, J. Lin, J. Chen, T. Huang, W. Gao, Compact descriptors for visual search. *IEEE Multimed.* **21**(3), 30–40 (2014)
33. J. Herrera, G. Molto, Detecting events in streaming multimedia with big data techniques, in *Proceedings of 2016 24th Euromicro International Conference on Parallel, Distributed, and Network-Based Processing (PDP)*, (Heraklion Crete, Greece, 2016), pp. 345–349
34. E. Dede, B. Sendir, P. Kuzlu, J. Weachock, M. Govindaraju, L. Ramakrishnan, Processing Cassandra datasets with Hadoop-Streaming based approaches. *IEEE Trans. Serv. Comput.* **9**(1), 46–58 (2016)
35. Z. Wang, S. Mao, L. Yang, P. Tang, A survey of multimedia big data. *China Commun.* **15**(1), 155–176 (2018)
36. B. Sadiq, F. Ur Rehman, A. Ahmad, A Spatio-temporal multimedia big data framework for a large crowd, in *Proceedings of 2015 IEEE International Conference on Big Data* (Santa Clara, CA, 2015), pp. 2742–2751

37. G. Lacey, G.W. Taylor, S. Areibi, Deep learning on FPGAs: past, present, and future. CoRR abs/1602.04283 (2016). <http://arxiv.org/abs/1602.04283>
38. B. Garcia, M. Gallego, L. Lopez, G.A. Carella, A. Cheambe, NUBOMEDIA: an elastic PaaS enabling the convergence of real-time and big data multimedia, in *Proceedings of 2016 IEEE International Conference on Smart Cloud (SmartCloud)* (New York, 2016) pp. 45–56
39. X. Wang, L. Gao, S. Mao, BiLoc: bi-modality deep learning for indoor localization with 5 GHz commodity Wi-Fi. *IEEE Access J.* **5**(1), 4209–4220 (2017)
40. Tanwar et al., An advanced internet of thing based security alert system for smart home, in *International Conference on Computer, Information and Telecommunication Systems (IEEE CITS-2017)*, vol. 21(2) (Dalian University, Dalian, China, 2017), pp. 25–29
41. S. Tanwar, S. Tyagi, S. Kumar, The role of internet of things and smart grid for the development of a smart city, in *Intelligent Communication and Computational Technologies, IoT4TD 2017* (Lecture Notes in Networks and Systems: Proceedings of Internet of Things for Technological Development), vol. 19 (Springer International Publishing, 2017), pp. 23–33
42. L. Lin, G. Ravitz, M.-L. Shyu, S.-C. Chen, Effective feature space reduction with imbalanced data for semantic concept detection, in *Proceedings of the IEEE International Conference on Sensor Networks, Ubiquitous, and Trustworthy Computing* 262–269 (2008)
43. E.Y. Gorodov, V.V. Gubarev, Analytical review of data visualization methods in application to big data. *J. Electr. Comput. Eng.* **22** (2013)
44. S. Pouyanfar, Y. Yang, S.-C. Chen, M.-L. Shyu, S.S. Iyengar, Multimedia big data analytics: a survey. *ACM Comput. Surv.* **51**(1):10:1–10:34 (2018)
45. A. Madan, M. Cebrian, D. Lazer, and A. Pentland. Social sensing for epidemiological behavior change, in *Proceedings of the 12th ACM International Conference on Ubiquitous Computing (Ubi Comp'10, 2010)* pp. 291–300
46. L. Selavo, A. Wood, Q. Cao, T. Sookoor, H. Liu, A. Srinivasan, Y. Wu, W. Kang, J. Stankovic, D. Young, and J. Porter. Luster: Wireless sensor network for environmental research in *Proceedings of the 5th International Conference on Embedded Networked Sensor Systems (SenSys'07, 2007)* pp. 103–116
47. M. Shamim Hossain and Ghulam Muhammad. Cloud-assisted industrial internet of things (iiot) – enabled framework for health monitoring. *Computer Networks*, **101**(Supplement C):192–202 (2016)

Energy Conservation in Multimedia Big Data Computing and the Internet of Things—A Challenge



Pimal Khanpara and Kruti Lavingia

Abstract In the recent days, wide-ranging cellular devices and purchaser gadgets in the Internet of Things (IoT) have created immense multimedia information in different types of media (for example, content, pictures, video, and sound). Due to this, there is a great increase in the research challenges for creating strategies and tools in addressing Multimedia Big Data (MMBD) for future IoT. As the worldwide framework for the ongoing data society, IoT empowers progressed benefits by inter-connecting (virtual as well as physical) things dependent on existing and advancing interoperable data and correspondence advancements. An immense measure of connected objects will be installed universally in a couple of years. In the meantime, the utilization of MMBD has been developing colossally since recent years, while organizations are rapidly getting on what they remain to pick up. Actually, these two advances are affecting and molding one another. In spite of the fact that they emerge from various application situations, MMBD can be together utilized with machine learning, AI, factual, and other progressed procedures, models, and techniques to investigate or locate the profound incentive behind the immense information originated from IoT. Actually, the registering knowledge, including transformative calculation, neural systems, and the fuzzy hypothesis, is relied upon to assume a vital job for these issues. It is as yet one of the most scorching and most challenging fields to create novel processing knowledge for the reasonable situations concerned with the MMBD for future IoT. In this paper, we focus on one of the most important research domains in MMBD IoT, Energy Conservation. IoT devices communicate through the wireless communication medium and are expected to transmit information whenever needed. The battery life of IoT devices is an important concern for researchers and device manufacturers. Many exhaustive efforts have been put by researchers in this area. Since most IoT devices are usually deployed in remote and hostile environments out of reach for human users, it may not be possible to charge and recharge

P. Khanpara (✉) · K. Lavingia

Department of Computer Science and Engineering, Institute of Technology, Nirma University, Ahmedabad, India

e-mail: pimal.khanpara@nirmauni.ac.in

K. Lavingia

e-mail: kruti.lavingia@nirmauni.ac.in

© Springer Nature Singapore Pte Ltd. 2020

S. Tanwar et al. (eds.), *Multimedia Big Data Computing*

for IoT Applications, Intelligent Systems Reference Library 163,

https://doi.org/10.1007/978-981-13-8759-3_2

batteries frequently. Moreover, in MMBD IoT applications, a large volume of multimedia traffic needs to be processed, which consumes precious network resources such as bandwidth and energy. Thus, devising protocols for conserving energy of IoT devices in such environments has become a very interesting topic of research. There are various ways to achieve energy conservation in the MMBD IoT environment. Some of the popular research inclinations are designing energy-efficient communication protocols, developing of mechanisms that enable IoT devices to self-generate, recycle, store and harvest energy, and modifying underlying protocol stack of communication technologies to support energy efficiency. Our paper mainly focuses on the investigation of existing technologies and mechanisms in the above domains. We first present the need for energy conservation briefly and then discuss the key points of existing solutions for saving energy in IoT communications. At the end of the paper, we summarize our findings to describe the advantages and limitations of existing mechanisms and provide insights into possible research directions.

Keywords IoT · MMBD · Energy conservation · IoT nodes · Energy harvesting · Energy management · Energy-efficient routing · Green IoT

1 Introduction

In the current era, the application domain of Ubiquitous Computing and IoT has been quickly increasing as it suggests impending web connectivity for all. IoT is a system of interrelated processing devices, mechanical and computerized machines, items, creatures, or individuals that are furnished with Inique Identifiers (UIDs) and has the capacity to exchange data through a communication network without expecting human-to-human or human-to-PC connection [1]. The increasing arena of IoT prompted a technical rebellion to develop intelligent and small-sized devices, outfitted with constrained storage, energy, and computing abilities. Such advances empower fabricating huge-scale heterogeneous systems that associate an enormous number of regular physical devices like intelligent sensors, actuators, cell phones, watches, healthcare devices, RFID labels, CCITVs, wearable devices, and so on. These objects are associated with the web through a wired or wireless medium. Wireless is the most favored medium to accomplish this extensive range of connectivity. These intelligent and smart devices can detect the data, gather the data and exchange the data. The working strategy of these devices relies upon one's requirements.

IoT has turned into a rising key innovation for forthcoming advancements, in which a heap of sensors, actuators, and brilliant questions in our day-to-day life are associated with the internet. These sensors and actuators (e.g., reconnaissance cameras, home machines, and condition observing sensors) are commonly outfitted with various types of microcontrollers, handsets, and conventions for correspondence of detecting and controlling information [2]. These genuine items, either sensors or actuators, are associated with one another to exchange their detected information to bring together servers, where data is, on the whole, put away and made accessible for

specific clients with legitimate access privileges. The exchange of information from one sensor/actuator hub to another sensor/actuator hub or to an IoT server is executed over another correspondence model termed Machine-Type Communications (MTC) or Machine to Machine (M2M) [3].

Insights uncover that Internet traffic is moving from non-multimedia information to interactive media information. This predominant strength connotes the significance and increment of multimedia use in our everyday undertakings. Consistent synthesis, agreeable detecting, connectivity, and self-sufficiency on the Internet of Multimedia Things (IoMT) framework opens ways to various opportunities to enhance administrations and applications through productive usage of huge multimedia information. Be that as it may, the heterogeneous idea of huge multimedia information desires versatile and customized recommendation frameworks for effective investigation of enormous information gathered in situations like reconnaissance, retail, telemedicine, traffic checking, and disaster management. Recommender frameworks are the specialized reaction to the way that we as often as possible depend on people groups' involvement, social standards, and provincial conventions when stood up to with another field of ability, where we don't have a wide learning all things considered, or where such learning would surpass the measure of data people can subjectively manage. This perception, in reality, proposes that recommender frameworks are a natural and profitable augmentation, permitting both end clients and multimedia specialist organizations to play a considerably more dynamic job in choosing semantically important substance and giving significant recommendations. For example, in smart urban areas, multimedia sensors enable overseers to effectively screen resources and exercises. Upgrades in the programmed translation of media huge information can improve the limit of keen city directors via self-governing responding to crisis circumstances, and suggesting powerful activities, accordingly decreasing reaction times altogether. Moreover, novel answers for interactive media information handling and the board in the IoMT biological system can upgrade personal satisfaction, urban condition, and smart city organization.

Big data processing incorporates data management as well as data analytics. Management of data requires effective cleaning, learning extraction, and reconciliation and total techniques. Though, IoMT's investigation depends on information modeling and understanding, which is increasingly more regularly performed by manipulating deep learning models. In a couple of years, blending ordinary and deep learning procedures, have displayed incredible guarantee in ingesting multimedia big data, investigating the worldview of exchange learning, predictive analytics, association rule mining, and so forth.

The key processing elements of an IoT network are shown in Fig. 1. As discussed above, device-to-device communication between sensors and actuators take place using the M2M model. The tiny devices involved in the IoT themselves have limited storage ability and the processing power.

There is a number of IoMT applications, which cover practically all the areas of our day-to-day life [4]. As shown in Fig. 2, on the basis of their impact on the environment, the applications can be categorized into domains such as IoT in Health

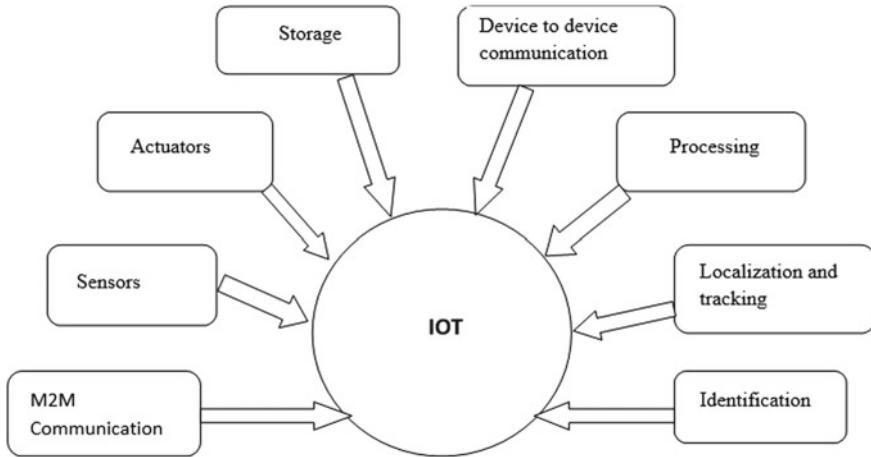

Fig. 1 Processing elements in IoT systems

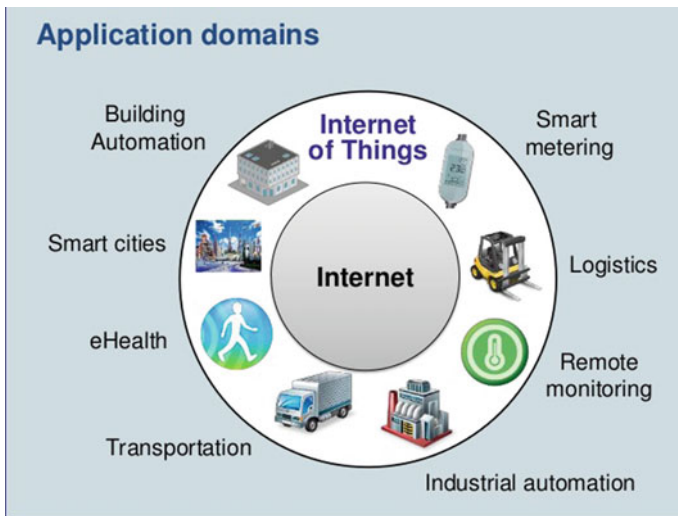

Fig. 2 IoT application domains

and Living, Industrial Automation, Habitation Monitoring, Smart city Management, Energy, Transportation, etc.

IoT in healthcare domain is useful for real-time tracking and identification of both patients as well as medical equipment in health care and smart data collection. IoT sensors are real-time health indicators, which in turn help in the diagnosis of patients. IoT can also be useful for sports domain where people are concerned about getting the dynamic, real-time information of a game. In the Industrial Automation field, IoT helps in designing Smart Industrial Plants, M2M as well as Smart Plant

Monitoring. If we look into Habitat monitoring, work is being carried out on Smart Agriculture, Smart Animals, and Smart Underwater Sensor Networks. To facilitate urban population growth, IoT has also emerged into applications such as Smart Buildings, Smart Environment, Smart Streetlight management systems as well as Smart Waste Management. IoT in energy management includes Smart Grid and Smart Metering. IoT also plays a vital role in Transportation for Smart Parking, Smart Traffic Congestion Detection, and Smart Logistics. The list of applications is never-ending. In all the areas of our routine life, the IoT is emerging at a great speed.

Figure 3 shows the IoT World Forum Reference Model [5]. The multi-layer design of the IoT World Forum is very intriguing as it outlines the different layers from the edge as far as possible up to the most vital layer, including Business Processes and Collaboration. At the bottommost layer, the edge lies the smart IoT devices also known as the “Things in IoT”. The next layer comprises of the communication and processing units that are responsible for the connectivity of these IoT devices. The Edge computing layer carries out Data element analysis and Transformation. The fourth layer is responsible for the accumulation of data. The fifth Layer carries out the task of data abstraction, whereas the top two layers involve applications such as Reporting, Analytics, and Control as well as Collaboration-related activities.

As described in [6], the features of IoMT are almost equal to those of IoT systems apart from Quality of Service (QoS) and required bandwidth. Therefore, energy-efficient solutions available for IoT applications can also be applied in IoMT domain. In this paper, we provide an exhaustive study and analysis of the latest actions to determine the Energy preservation challenges for resource compelled IoT gadgets and talk about problems and explanations given in various types of survey works. This review inspects the writing with a particular spotlight on Energy Management in

IoT World Forum Reference Model

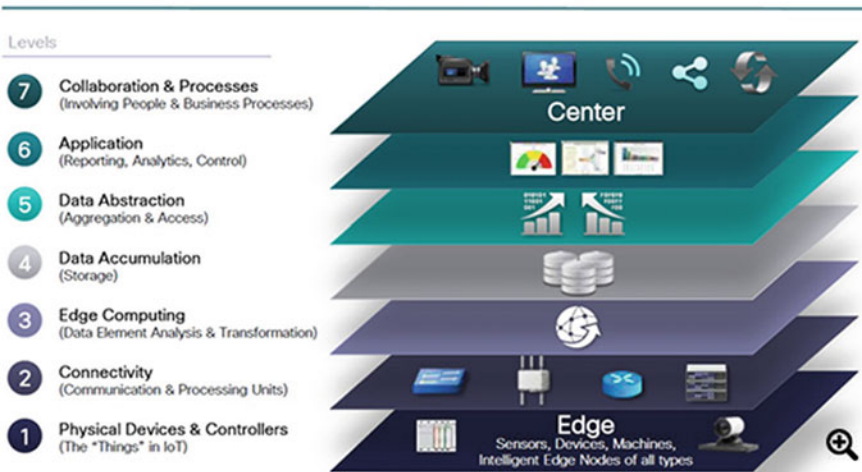

Fig. 3 IoT World Forum Reference Model [5]

terms of Efficient Communication, Routing, Self-Generating, and Recycling Energy and Energy Harvesting and Storing.

1.1 Research Problems in IoMT

The IoMT is still at an initial level of development, and numerous issues/look into challenges must be resolved before it is extensively accepted. A considerable amount of these challenges are technological, as well as interoperability, adaptability, and scalability, as a large number of diverse gadgets will be associated, yet choosing how to put resources into the IoMT is a test for corporate, and there are additionally societal, ethical, and legitimate issues, together with privacy and security of data gathering, which need to be settled.

There is a number of issues of research related to the IoMT. Some of the issues are well known now, there may be many new to emerge later on. These issues shield the entire field, comprising the technical ones of outlining, overseeing plus utilizing a multi-industrial, multinational multi-innovation framework, the commercial difficulties of creating IoMT plans of action, as well as the hierarchical, political, and societal difficulties of a novel innovation that guarantees to modify the manner of our living and working style in significant means.

The major research problems of IoMT can be categorized into Design, Scientific/Engineering, and Management/Operations categories. The design would include the concepts of Architecture, Interoperability, Scalability, Mobility, Security, and Privacy [7]. Scientific/Engineering domain includes Energy Efficiency, Power Reliability, and Robustness, whereas, Management/operations would include Software Development Availability, Data Management/Information Fusion, and Cloud Computing Performance [8, 9].

1.2 Importance of Energy Conservation in IoMT

In practical scenarios, the IoMT usage comes across numerous challenges. It is because of the devices that are comprised in the IoMT, must detect/sense information constantly [10]. Due to this constant sensing and processing of data, a large amount of energy gets consumed and hence there is a necessity for enhancing energy. An enormous number of nodes are involved in the IoMT network, and hence, it devours additional energy for the entire system [11, 12].

Energy has to be properly managed so that no node moves toward becoming energy deficient [13]. This would in turn help in making the network operational for an extensive amount of time. To achieve this, each and every node in the network of sensors ought to have executed a proficient energy management protocol.

Energy is believed to be the utmost critical asset for a sensor node, particularly if any sensor node is kept in an environment such as a distributed network and on the off

chance that it isn't possible to supply extra energy to the sensor node, as soon as the existing energy gets finished [14]. Hence, an energy management system which can adjust the demand and supply is expected, to avoid energy deficiency circumstances in the network [15]. The battery is the main controlling source of a node in sensor networks which can either be energized by recharging or changed/replaced on the basis of the environment where it has been deployed [16].

For finding out energy-efficient mechanisms, a lot of research work has been carried out. Work is being carried out on designing energy-efficient communication protocols, modifying underlying stack of communication technologies to support energy efficiency, designing mechanisms for helping the IoT devices to self-generate, store, recycle, and harvest energy [15, 17].

The main motto of our paper is to inspect the different existing mechanisms for energy conservation in IoT devices and analyze those mechanisms in terms of their efficiency. We summarize our findings to describe the advantages and limitations of existing mechanisms and provide insights into possible research directions.

2 Related Work

The scope of this survey is to first recognize the main research challenges. Numerous ongoing studies on the IoMT, incorporate an area on exploring difficulties, and we have endeavored to merge their outcomes for our motivations. This was a troublesome undertaking because of contrasts in wording by various researchers, the way that the distinctive research challenges can't be totally isolated from one another, and the way that they can be depicted at various levels of detail. For instance, "IoT design" may be considered as a very high-level research challenge, but this incorporates a various low level of research issues, for example, "architecture", "interoperability" as well as "adaptability" [18, 19]. Every one of these lesser level research difficulties may incorporate other lower level of research issues, e.g., for an Architectural Structure for the IoT, IEEE's Standard incorporates the exploration difficulties of assurance, security, protection as well as safety. A few writers view IoT Standardization as a self-imbibed challenge [20, 21]. The views differ from author to author.

Some of the surveys that we have looked upon include the following: Kim and Kim [22] adjusted an Analytic Hierarchy Procedure exemplary related to three IoT usages: health-related services, energy management, and logistics, utilizing norms of innovation, showcase prospective, and regulatory situation. Review information that was examined utilizing this model demonstrated that marketplace potential was the most critical paradigm in the model's principal layer and reasoned that the most encouraging usage from the ICT specialist's Technical point of view is the IoT logistics. Healthcare services need to beat client obstructions and technical dependability requires to be acknowledged. Energy administration necessitates government bolster (Korean Smart Grid activity). Haghghi et al. [23] utilized a game theory methodology to deal with streamline dissemination of task and Energy utilization in the IoT networks. To deal with deciding costs for solving clashes among peers, an

auction-based approach was used. The discrete-event simulation would give off an impression of being a perfect way to deal with concentrating a significant number of the outline and designing difficulties for IoT, like the scalability and energy efficiency can be developed in a situation wherein new ideas can be steadily tried. Researchers Esmaeili and Jamali [24] connected GA for enhancing energy utilization, which is a key aspect in the case of IoT networks. The authors here have designed and proposed a few more algorithms for enhancing energy utilization in the field of WSNs.

3 Methodology: Classification of Existing Energy Conservation Mechanisms

Research work is being carried out by a number of researchers for finding efficient solutions for conserving energy for IoT devices [25]. The authors in their literature have carried out a survey on the basis of different categories.

Musaddiq et al. [26] have provided a review on resource management by taking IoT Operating Systems into consideration. The authors have carried out a survey on resource management concepts of Contiki, TinyOS, and FreeRTOS which includes all the operating system concepts of process organization, memory organization, energy management, the organization of files, and communication management. Future research directions and challenges in resource management of IoT OSs are also provided.

Ryan and Watson [27] in their paper have focused on the methods of Operations Research (OR) to deal with the research challenges faced by IoT. The authors first identify the research problems, and then proposes contribution in the means of solutions where OR can be used to deal with the problem.

Abbas and Yoon [28] in their paper carried out a survey on providing solutions for energy conservation in resource-constrained IoT devices. Their main focus is on wireless networking aspects of IoT Energy Conservation. Their survey focuses on providing energy conservation solutions for devices based on their network architecture such as Wireless Networking—WWAN, WLAN, and WPAN.

Our paper mainly focuses on a survey of mechanisms that are already proposed by different researchers. We have categorized these solutions on the basis of the fol-

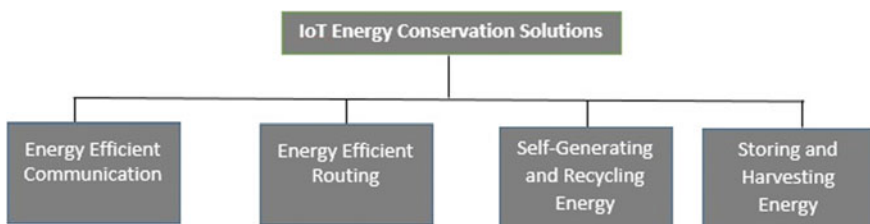

Fig. 4 Classification of existing energy conservation solutions for IoT applications

lowing categories: Solutions for Energy-Efficient Communication, Energy-Efficient Routing, Solutions for Self-generating and Recycling Energy/Green IoT and Solutions for Storing and Harvesting energy. This classification is shown in Fig. 4.

4 Solutions for Energy Management

Various techniques for conserving energy in IoT communications have been proposed by researchers [29, 30]. This section provides an overview of such existing mechanisms. These mechanisms are grouped based on their objectives and key techniques for implementation. The analysis of these mechanisms is presented in the next section.

4.1 Mechanisms for Energy-Efficient Communication

The authors of [31] have described an energy-efficient management framework for the IoT environment. The main idea proposed in this paper is to regulate the duty cycles of IoT sensors considering QoI (Quality of Information) requirements. This paper also proposes an idea to cover the critical task set to choose sensor services. This concept is based on QoI-aware sensor-to-task relevance. The advantage of this proposal is that it can be used with any underlying routing protocols for a variety of applications to preserve energy in communication. Moreover, the energy management decision is taken dynamically to deal with constraints such as service delay and optimum level of energy. The authors have also considered the latency of processing and signal propagation time and shown the impact of these factors on average measured delay probability. The proposed algorithm is greedy in nature and executes mainly three steps: shutting down sensors which are not perilous to the recent task; keeping the current status of each sensor for every task and computing the least energy requirement likelihood for task transitions. The proposed framework is applicable to certain realistic scenarios.

For energy-efficient and highly scalable IoT, the concept of multihop networking is presented in [32]. The mechanism uses blind cooperation along with multihop communications to improve scalability. Power control is necessary to have efficient blind cooperation. The authors also discuss an uncoordinated power control technique in conjunction with blind cooperative clustering to be implemented in each device. As claimed in the paper, this mechanism outperforms the simple point-to-point routing mechanism. Multihop networking helps reduce the overhead associated with the underlying routing protocols and enhances scalability. An upper bound for the mean transmit power level is computed as a function of cluster size. The proposed mechanism is evaluated based on the normalized transport rate. The performance of this mechanism is improved when there is a small deviation between the real size and assessed the size of a cooperative cluster.

According to the authors of [33], Ferroelectric RAM (FRAM) technology can be used in IoT edge devices to control unreliable power supply. FRAM is a volatile memory technology and can be treated as a unified memory. FRAM-based solutions offer reliability but they are energy inefficient in comparison of SRAM due to a greater access latency. In contrast to FRAM-based solutions, SRAM-based solutions provide a high level of energy efficiency but they are not reliable in the face of power loss. The authors present a hybrid approach which is based on FRAM-SRAM MCUs and uses shrewd memory mapping to get reliability from FRAM and efficiency of SRAM-based systems. The memory mapping technique proposed in this paper is energy-aware and lowers the consumption of energy without affecting reliability. The proposed technique uses eM-map-based representation to compute the optimum memory map for the functions which establish programs. This makes the solution platform-portable and energy-aligned. To enhance energy efficiency and performance, the solution aligns system's powered-on time intervals to function execution bounds. The authors claim a 20% reduction in energy consumption when their proposed solution is used.

Van et al. [34] propose the use of converged Fi-Wi (Fiber-Wireless) access networks to develop a collective communication facility for the Internet of Things. The paper discusses the applicability and difficulties associated with the design and implementation of energy-efficient IoT infrastructures in the optical backhaul network. This effort discusses the usage of converged Fi-Wi networks which combine a capacity-centric OAN backhaul and a coverage-centric multi-RAT front-end network to support the Internet of Things infrastructure. The paper proposes mechanisms for power saving, scalability, energy efficiency, H2H/M2M coexistence and network integration for IoT deployment scenarios. The Authors state that in small-scale Fi-Wi-based IoT scenarios, approximately 95% of energy can be preserved by implementing TDMA-based scheduling. In the large-scale LTE-based IoT setups, up to 5 years of battery life can be attained by incorporating the suggested DRX technique.

Suresh et al. [35] describe an energy-efficient mechanism called EEIoT (Energy-Efficient Internet of Things) for IoT applications. This mechanism is based on the concept of MECA (Minimum Energy Consumption Algorithm). MECA techniques are not efficient as they do not consider energy consumption in sensor nodes. The goal of EEIoT is to control factors that energy consumption in IoT efficiently. EEIoT has a self-adaptation property and can lower energy harvesting to a great extent in the IoT environment. Different energy consumption factors have been considered by the authors to make the implementation of EEIoT effective. The paper also describes the effective method of dealing with energy efficiency requirements for data streams in big data platforms. Here, the objective is to maintain connectivity and normal functionality despite low energy levels. According to the authors, EEIoT outperforms other traditional methods of energy saving.

4.2 Mechanisms for Energy-Efficient Routing

A hybrid routing protocol for M2M sensor networks for wireless IoT applications has been proposed in [36]. In this paper, nonuniform energy consumption, scalability of network and performance degradation issues have been addressed. To handle these issues, a scalable energy-efficient clustering method is presented. In this approach, numerous mobile sink nodes have been considered for large-scale M2M sensor networks to discover the shortest routing trail to the destination node from the cluster head. It helps to lengthen the lifespan of the network. The rotation used in the selection of cluster heads results in a better distribution of energy and traffic among all sensing nodes in the network. Because of this, the lifetime of the nodes and hence of the network is increased. It also helps in improving end-to-end delay and throughput of the communication process. Simulation outcomes indicate that the use of the suggested clustering procedure and multiple mobile sink nodes enhance the network lifetime and energy distribution. The authors claim significant improvement in the routing process compared to the efficiency of the existing routing protocol.

Alkuhlani and Thorat [37] address a trade-off between the privacy of locations and energy consumption in the IoT environment. The authors of this paper suggest a secure procedure to preserve the location secrecy of the source node by modifying the routing procedure, and energy-aware load balancing protocol based on the selection of random routes to support fair energy consumption with path diversity. In this method, each packet is forwarded to a random node. To keep the actual route of the packet confidential and maximize the confidentiality, tunnels of M intermediate hops are defined. This keeps the location of the source node hidden from the attacks based on backtracking. The paper explains an energy-aware load balancing RPL-based protocol which is integrated with multiple random path-finding techniques such that each packet is forwarded in different directions on a random basis. This idea prevents attackers to eavesdrop the exact location of the source node using back-tracing and may reach a different node.

An energy proficient self-organizing multicast routing protocol called ESMR is presented in [38] for IoT applications. In this protocol, there are two categories of nodes: network nodes and nonnetwork nodes. The nodes which are present in the network are treated as network nodes. The other category of nodes, nonnetwork nodes use Markov process based diverse measurements for computing a network nodes' weight. The protocol selects a node with the highest weight as a sink node. Nonnetwork nodes can enter into the network by sending requests to sink nodes. This is how a tree-like structure is constructed in the network. The structure of the network is balanced in stages to control energy levels. Automatic AVL tree pruning operation is used to prolong the network lifetime. When the network grows in size, the packet loss proportion does not increase due to pruning and this results in extending the lifespan of the network. In the AVL tree structure, a node is declared as a sink node only if can poise child nodes, remaining energy, hop count and the spatial deviation between the sink node and its child nodes. The height of the tree is also optimized in ESMR. The topology of the network is changed during data

communication based on the future energy of sink nodes. The authors of this paper claim that a dependable tree-based network can be built using ESMR which improves the lifetime of the network and lowers the consumption of energy. The success rate of packets is shown to be improved in ESMR compared to AODV (Ad hoc On-Demand Distance Vector Routing), DSDV (Destination Sequence Distance Vector Routing), and ADMR (Adaptive Demand-Driven Multicast Routing) protocols.

Under many application areas in the IoT, the mobility of nodes and P2P (Point-to-Point) communication are the basic requirements. Therefore, such applications should have routing mechanisms that support mobility and discovery of best P2P paths and focus on energy efficiency as well. According to the authors of [39], the existing P2P routing protocols for the IoT do not upkeep the movement of nodes. Hence, they suggest a novel energy-efficient mobility-aware routing protocol titled MAEER (Mobility-Aware Energy-Efficient Routing) for the IoT scenarios. This protocol minimizes the total number of partaking nodes in the P2P path-finding process to lower the ingesting of energy. It also provides a mechanism to facilitate mobility with improved packet delivery ratio. As stated in this paper, the energy depletion of MAEER is 24% less compared to P2P-RPL protocol.

Behera et al. [40] describe the altered LEACH (Low Energy Adaptive Clustering Hierarchy) protocol to decrease the energy ingesting in sensor nodes for IoT applications. This protocol defines a threshold for selecting cluster heads with simultaneously changing the power levels between the nodes. The authors state that their modified LEACH protocol performs better than the existing LEACH and other energy-efficient protocols in terms of network lifespan, throughput, and stability period when used in different scenarios with varying network size, the density of nodes and available energy.

4.3 Mechanisms for Self-generating and Recycling Energy/Green IoT

Shaikh et al. [41] describe the efficient deployment of different technologies such as sensors, Internet, and other smart objects in the IoT environment to make it green IoT. According to the definition given in this paper, Green IoT is defined as the IoT which uses either hardware or software-based energy-efficient procedures. The objective of green IoT is to diminish the effect of the greenhouse effect of IoT services and applications. The life sequence of green IoT mainly focuses on reducing the greenhouse effect in the design, production, utilization, and disposal or cycling processes. The authors of these paper have also considered numerous facets such as applications, communications, crucial enablers, and services to achieve green IoT. The survey of various solutions for achieving green IoT is also presented. The paper provides the list of IoT application areas where it is possible to conserve energy to have the green environment. The list of key enablers of green IoT and various methods to implement energy-efficient solutions with respect to these enablers are

also discussed. Domains of green IoT such as service management, heterogeneous communication, physical environments, and sensor cloud integration are required to be considered for providing efficient communication among them. Future scope in existing efforts is highlighted to implement green IoT.

An energy-efficient protocol stack named GREENNET is presented in [42]. This solution is proposed for IP-enabled wireless sensor networks but can be used in the IoT environment. The protocol stack executes on a photovoltaic cell energy-enabled hardware platform. GREENNET integrates different standard mechanisms and improves the performance of existing protocols to a great extent. It provides a discovery mechanism that facilitates the adjustment of the duty cycles of harvested nodes to the remaining energy in the network and leverages network performance. GREENNET also supports the security of standard operations at the link layer and data payload. It does not utilize multiple channels to increase the capacity of the network. Robustness and mobility of the nodes are considered in the proposed scheme.

An amended tiered clustering protocol named EH-mulSEP (Energy Harvesting enabled Multi-level Stable Election Protocol) is given in [43] for green IoT-based heterogeneous wireless sensor networks. The authors of this paper discuss the effects of energy harvesting methods in large-scale IoT systems when a large number of relay nodes that harvest energy and obtain the accumulated information from the selected cluster heads. Relay nodes forward this information to the base stations. The paper also presents a general computation method for multi-level weighted election possibility which can facilitate up to n levels of heterogeneous nodes with their corresponding level of primary energies. More than three types of nodes are considered for heterogeneity, which provides generic models for higher initial energy levels in sensor nodes. The major goal of EH-mulSEP is to reduce the energy depletion in battery-operated sensor nodes in IoT applications and maximize the conservation of energy by increasing the scalability and lifespan of the network. Using an intermediary energy harvesting layer between the base stations and cluster heads, EH-mulSEP improves the performance of the network in terms of throughput, permanence, scalability, network lifespan, and energy consumption in comparison of the other versions of SEP protocols in similar deployment settings.

4.4 Mechanisms for Storing and Harvesting Energy

IoT systems need sensing, data congregation, storage, handling, and data transmission capabilities. Real time, as well as virtual sensors, are used to provide these capabilities. Mahapatra et al. [44] describe robustness in data delivery process and energy efficiency as the major requirements of IoT communication. The authors of [44] propose data awareness, cluster head selection using active RFID tags and energy harvesting in the IoT the environment. The proposed protocol, DAEECI (Data Aware Energy-Efficient Distributed Clustering protocol for IoT), saves energy involved in the cluster head selection process. It uses active RFID tags to reduce dispensation energy by including data awareness factor and enhancing lifespan by infusing RF

energy harvesting. Energy consumption models are formulated in each round and the same is sent from sensor nodes to BS through gateways. The authors claim a significant enhancement in network lifetime and data delivery when DAECCI is deployed.

A novel sensor architecture named EcoSense is presented in [45]. Unlike conventional software-based techniques, EcoSense uses a hardware-based reactive sensing technique that removes the energy waste generated by a sensor working in either standby mode or sleep mode. If the target events are available, a sensor is powered off to reserve energy. When the target events are present, a reactive connection component harvests energy from the events and activates the sensor again. Light and RF-driven sensors are used to sense lights and RF signals and provide fair reaction distances. The reactive connection module is used to control the connections between the power supply unit and sensors. By default, this module is disabled so no power is used by the sensors. When a target event takes place, the energy harvester module stores the energy correlated to the events and enables sensors by linking them to the power supply. The performance is evaluated based on reaction distance, reaction times, and working duration. Results state that the suggested mechanism is applicable only in short-range applications.

A modified routing mechanism for the 802.11 networks is presented in [46]. The routing protocol proposed in this paper uses energy harvesting data for making path-finding decisions. The objective of this modified routing protocol is to extend the network lifetime when it is set up in an energy-constrained scenario. When no viable energy source is available, network nodes harvest energy from the environment. This logic is incorporated into the routing activity so that the network operation can execute without disruptions and harvested energy can be utilized properly. The routing algorithm determines energy-efficient routes for transmitting messages through the network. To achieve this, the algorithm maintains energy harvesting information along with the level of residual energy at each hop in the network. To see the effect of the proposed routing protocol on energy management, the authors presented the simulation of the proposed logic with varying energy harvesting conditions. According to the results given in the paper, the proposed protocol can improve network lifetime by approximately 30% in low energy harvested scenarios. In high energy harvested conditions, the proposed algorithm is claimed to avert the energy hole problem successfully.

The infrastructure of the IoT comprises of a big number of battery-driven devices with restricted lifetime. The manual replacement of their batteries is not feasible in large-scale deployments. The host stations need to communicate with the distributed sensor devices and this communication requires a significant amount of energy based on the physical distance between the host and sensing nodes. An energy-efficient multi-sensing platform is presented in [47]. This paper addresses long-range device communication, energy harvesting and self-sustainability of low-power short-range devices in the network. The idea to design a power-efficient solution and reduce the quiescent current in the radio devices even when they are always on in the wireless channel. The proposed platform supports a heterogeneous long and short-range network architecture to minimize latency and energy consumption during the

listening phase. For better energy management, the architecture combines LoRaTM and wake up radio. This results in increased communication efficiency and reduced power consumption.

Yang et al. [48] explore resource distribution for a machine to machine-aided cellular network to achieve energy efficiency and nonlinear energy harvesting. The proposed method uses two major access strategies, NOMA (Non-Orthogonal Multiple Access) and TDMA (Time-Division Multiple Access). This method attempts to reduce the total energy consumption in the network through joint circuit power control and time allocation. The authors state that both access strategies can be used for optimal machine communication with minimum energy consumption and improved throughput. Energy consumption of each machine type communication device is defined as a convex function with regard to the assigned communication duration. Using the optimum transmission power conditions of machine type communication devices, the optimization issue for NOMA can be transformed into an equivalent issue whose solution can be derived suboptimally. The paper also discusses the transformation of the original TDMA optimization to an equivalent tractable problem by considering appropriate variable transformation. This transformed problem can then be solved iteratively. The authors show that NOMA requires less amount of energy compared to TDMA with low circuit power control machine type communication devices. In the case of high circuit power control of machine type communication devices, TDMA does better than NOMA, in terms of energy efficiency. The paper also analyses the total energy consumed in NOMA and TDMA policies in uplink M2M communications. Energy minimization problem is stated in terms of circuit power consumption, throughput, energy causality, and transmission power constraints. Either NOMA or TDMA can be used based on the circuit power control in machine type communication devices.

5 Analysis of Existing Energy Conservation Mechanisms

Table 1 recapitulates the existent energy-conserving mechanism for various IoT applications with respect to the category of the solution, key technology used, and approaches. This table also lists the advantages and drawbacks or limitations of these energy-conserving mechanisms.

6 Conclusions

This paper has presented an inclusive investigation of energy preserving issues and existing mechanisms for energy-constrained IoT environment. The existing energy conservation mechanisms are classified based on the techniques used for conserving energy in battery-operated IoT devices and networks. These mechanisms have been studied and analyzed based on various aspects such as distributed and het-

Table 1 Existing energy conservation mechanisms for IoT applications

Protocol	Category	Key techniques implemented	Advantages	Limitations	Approach
[31]	Energy-efficient communication	QoI-aware energy-efficient framework	Transparent and compatible with lower protocols	Applicable in specific scenarios	Uses sensor-to-task relevancy and critical covering set concepts
GREENNET [42]	Green IoT	Energy-efficient protocol stack for sensor nodes	Improved performance of existing protocols	Limited network capacity	Uses photovoltaic cell energy-enabled hardware platform
[41]	Green IoT	Key enablers and methods to implement green IoT	Integration of IoT domains for smooth interaction	Discusses only theoretical aspects	Various application domains of green IoT
[32]	Energy-efficient communication	Multihop networking, blind cooperative clustering	Reduced overhead in the underlying protocol, improved scalability	Efficiency depends on cluster size	Sets upper bound for mean transmit power level
[33]	Energy-efficient communication	Hybrid FRAM-SRAM MCUs, energy alignment	Platform portability reduced power consumption	Computation complexity	Uses optimal memory maps
DAEECI [44]	Energy harvesting	Data awareness, cluster head selection using active RFID tags	Energy saving cluster head selection, improved lifetime	None	Computes energy consumption models in each round
[34]	Energy-efficient communication	Integrated capacity-centric OAN backhaul and a coverage-centric multi-RAT front-end network	Improved battery life	None	Uses converged Fi-Wi access networks

(continued)

Table 1 (continued)

Protocol	Category	Key techniques implemented	Advantages	Limitations	Approach
EcoSense [45]	Energy storage and harvesting	Hardware based on-demand sensing technique	Energy consumption only for desired events	Useful for only short-range applications	Controlled connection between sensors and the power supply unit
[46]	Energy storage and harvesting	Energy-aware routing protocol	Prolonged network lifetime, prevents energy hole	Cannot be used with existing routing protocols, increased computational complexity	Additional information needs to be maintained at every node
EEToT [35]	Energy-efficient communication	Modified MECA algorithm	Self-adaptation of energy harvesting	Specific to big data platforms	Based on MECA
[36]	Energy-efficient routing	Scalable energy efficient clustering	Fair distribution of energy, prolonged network lifetime	None	Hybrid routing protocol for M2M sensor networks
[47]	Energy harvesting	Energy efficient multi-sensing platform	Reduced latency, self-sustainability	None	Heterogeneous, long-range device communication
[37]	Energy-efficient secure routing	Energy-aware load balancing routing protocol	Location privacy, fair energy consumption	Increased packet forwarding	Uses path diversity
[48]	Energy harvesting	Circuit power control	Improved throughput, optimal machine communication	Selection of access mechanism is difficult	Considers NOMA and TDMA access mechanisms

(continued)

Table 1 (continued)

Protocol	Category	Key techniques implemented	Advantages	Limitations	Approach
ESMR [38]	Energy-efficient routing	Energy-efficient self-organizing multicast routing	Prolonged network lifespan, improved packet success rates	None	Uses AVL tree pruning
MAEER [39]	Energy-efficient routing	Energy-efficient mobility-aware routing	Supports mobility, improved packet delivery ratio	High memory requirement	Reduces the number of participating nodes for optimal route discovery
EH-mulSEP [43]	Green IoT	Energy harvesting enabled multi-level stable election	Improved scalability, throughput, network lifetime	Uses fixed traffic patterns	Uses multi-level weighted election probability on heterogeneous nodes
Modified LEACH [40]	Energy-efficient routing	Threshold-based cluster head selection	Enhanced throughput, network lifespan	Cannot be used with heterogeneous routing	Modification in LEACH protocol

erogeneous working environments, adjustment of duty cycles, access control, and congestion avoidance techniques, sleep time control techniques during inactivity periods, switch off and standby time of radio, resource management and scheduling, efficient cluster head selection schemes, prolonged network lifetime, throughput, scalability, and so on. As features of IoMT and IoT are almost similar, energy conservation techniques proposed for IoT systems can be used for IoMT applications to achieve energy efficiency. The survey presented in this paper evaluates the existing solutions considering various performance metrics to address energy conservation issues.

References

1. Y. Agarwal, A.K. Dey, Toward building a safe, secure, and easy-to-use internet of things infrastructure. *IEEE Comput.* **49**(4), 88–91 (2016)
2. A. Sheth, Internet of things to smart iot through semantic, cognitive, and perceptual computing. *IEEE Intell. Syst.* **31**(2), 108–112 (2016)
3. M. Weyrich, C. Ebert, Reference architectures for the internet of things. *IEEE Softw.* **33**(1), 112–116 (2016)
4. S.M. Alzahrani, Sensing for the internet of things and its applications, in *2017 IEEE 5th International Conference on Future Internet of Things and Cloud: Workshops (W-FiCloud)* (IEEE, 2017), pp. 88–92
5. C. Rostetter, S. Khoshafian, *The Adaptive Digital Factory: IoT Reference Architectures* (2016), <https://www.pega.com/insights/articles/adaptive-digital-factory-iot-reference-architecture>
6. S.A. Alvi, B. Afzal, G.A. Shah, L. Atzori, W. Mahmood, Internet of multimedia things: vision and challenges. *Ad Hoc Netw.* **33**, 87–111 (2015)
7. A. Al-Fuqaha, M. Guizani, M. Mohammadi, M. Aledhari, M. Ayyash, Internet of things: a survey on enabling technologies, protocols, and applications. *IEEE Commun. Surv. Tutor.* **17**(4), 2347–2376 (2015)
8. A. Rodriguez, A. Ordóñez, H. Ordoñez, Energy consumption optimization for sensor networks in the IoT, in *2015 IEEE Colombian Conference on Communications and Computing (COLCOM)* (IEEE, 2015), pp. 1–6
9. T. Hourset, L. Lizzi, F. Ferrero, C. Danchesi, S. Boudaud, Energy efficient reconfigurable antenna for ultra-low power IoT devices, in *2017 IEEE International Symposium on Antennas and Propagation & USNC/URSI National Radio Science Meeting* (IEEE, 2017), pp. 1153–1154
10. T.D. Nguyen, J.Y. Khan, D.T. Ngo, A distributed energy-harvesting-aware routing algorithm for heterogeneous IoT networks. *IEEE Trans. Green Commun. Netw.* (2018)
11. P.V. Krishna, M.S. Obaidat, D. Nagaraju, V. Saritha, CHSEO: an energy optimization approach for communication in the internet of things, in *GLOBECOM 2017–2017 IEEE Global Communications Conference* (IEEE, 2017), pp. 1–6
12. S. Santiago, L. Arockiam, A novel fuzzy based energy efficient routing for internet of things, in *2017 International Conference on Algorithms, Methodology, Models and Applications in Emerging Technologies (ICAMMAET)* (IEEE, 2017), pp. 1–4
13. Z. Sun, C.H. Liu, C. Bisdikian, J.W. Branch, B. Yang, QoS-aware energy management in internet-of-things sensory environments, in *2012 9th Annual IEEE Communications Society Conference on Sensor, Mesh and Ad Hoc Communications and Networks (SECON)* (IEEE, 2012), pp. 19–27
14. S. Mallick, A.Z.S.B. Habib, A.S. Ahmed, S.S. Alam, Performance appraisal of wireless energy harvesting in IoT, in *2017 3rd International Conference on Electrical Information and Communication Technology (EICT)* (IEEE, 2017), pp. 1–6
15. M.E. Khanouche, Y. Amirat, A. Chibani, M. Kerkar, A. Yachir, Energy-centered and QoS-aware services selection for internet of things. *IEEE Trans. Autom. Sci. Eng.* **13**(3), 1256–1269 (2016)
16. D. Chen, W. Yang, J. Hu, Y. Cai, X. Tang, Energy-efficient secure transmission design for the internet of things with an untrusted relay. *IEEE Access* **6**, 11862–11870 (2018)
17. Q. Ju, H. Li, Y. Zhang, Power management for kinetic energy harvesting IoT. *IEEE Sens. J.* **18**(10), 4336–4345 (2018)
18. C.X. Mavromoustakis, J.M. Batalla, G. Mastorakis, E. Markakis, E. Pallis, Socially oriented edge computing for energy awareness in IoT architectures. *IEEE Commun. Mag.* **56**(7), 139–145 (2018)
19. T. Wan, Y. Karimi, M. Stanacevic, E. Salman, Energy efficient AC computing methodology for wirelessly powered IoT devices, in *2017 IEEE International Symposium on Circuits and Systems (ISCAS)* (IEEE, 2017), pp. 1–4
20. S.S. Prasad, C. Kumar, An energy efficient and reliable internet of things, in *2012 International Conference on Communication, Information & Computing Technology (ICCICT)* (IEEE, 2012), pp. 1–4

21. C.C. Liao, S.M. Cheng, M. Domb, On designing energy efficient wi-fi P2P connections for internet of things, in *2017 IEEE 85th Vehicular Technology Conference (VTC Spring)* (IEEE, 2017), pp. 1–5
22. S. Kim, S. Kim, A multi-criteria approach toward discovering killer IoT application in Korea. *Technol. Forecast. Soc. Chang.* **102**, 143–155 (2016)
23. M. Haghighi, K. Maraslis, T. Tryfonas, G. Oikonomou, A. Burrows, P. Woznowski, R. Piechocki, Game theoretic approach towards optimal multi-tasking and data-distribution in IoT, in *2015 IEEE 2nd World Forum on Internet of Things (WF-IoT)* (IEEE, 2015), pp. 406–411
24. M. Esmaeili, S. Jamali, A survey: optimization of energy consumption by using the genetic algorithm in WSN based internet of things. *CIIT Int. J. Wirel. Commun.* (2016)
25. M.H. Asghar, N. Mohammadzadeh, Design and simulation of energy efficiency in node based on MQTT protocol in internet of things, in *2015 International Conference on Green Computing and Internet of Things (ICGCIoT)* (IEEE, 2015), pp. 1413–1417
26. A. Musaddiq, Y.B. Zikria, O. Hahm, H. Yu, A.K. Bashir, S.W. Kim, A survey on resource management in IoT operating systems. *IEEE Access* **6**, 8459–8482 (2018)
27. P. Ryan, R. Watson, Research challenges for the internet of things: what role can OR play? *Systems* **5**(1), 24 (2017)
28. Z. Abbas, W. Yoon, A survey on energy conserving mechanisms for the internet of things: wireless networking aspects. *Sensors* **15**(10), 24818–24847 (2015)
29. C. Chilipirea, A. Ursache, D.O. Popa, F. Pop, Energy efficiency and robustness for IoT: building a smart home security system, in *2016 IEEE 12th International Conference on Intelligent Computer Communication and Processing (ICCP)* (IEEE, 2016), pp. 43–48
30. H. Khodr, N. Kouzayha, M. Abdallah, J. Costantine, Z. Dawy, Energy efficient IoT sensor with RF wake-up and addressing capability. *IEEE Sens. Lett.* **1**(6), 1–4 (2017)
31. C.H. Liu, J. Fan, J. Branch, K. Leung, Towards QoI and energy-efficiency in internet-of-things sensory environments. *IEEE Trans. Emerg. Top. Comput.* **1**, 1, 2014
32. A. Bader, M.S. Alouini, Blind cooperative routing for scalable and energy-efficient internet of things, in *2015 IEEE Globecom Workshops (GC Wkshps)* (IEEE, 2015), pp. 1–6
33. H. Jayakumar, A. Raha, V. Raghunathan, Energy-aware memory mapping for hybrid FRAM-SRAM MCUs in IoT edge devices, in *2016 29th International Conference on VLSI Design and 2016 15th International Conference on Embedded Systems (VLSID)* (IEEE, 2016), pp. 264–269
34. D.P. Van, B.P. Rimal, J. Chen, P. Monti, L. Wosinska, M. Maier, Power-saving methods for internet of things over converged fiber-wireless access networks. *IEEE Commun. Mag.* **54**(11), 166–175 (2016)
35. K. Suresh, M. RajasekharaBabu, R. Patan, EEIoT: energy efficient mechanism to leverage the internet of things (IoT), in *International Conference on Emerging Technological Trends (ICETT)* (IEEE, 2016), pp. 1–4
36. B.R. Al-Kaseem, H.S. Al-Rawashidy, Scalable M2M routing protocol for energy efficient IoT wireless applications, in *2016 8th Computer Science and Electronic Engineering (CEECE)* (IEEE, 2016), pp. 30–35
37. A.M.I. Alkuhlani, S.B. Thorat, Enhanced location privacy and energy saving technique for sensors in internet of things domain, in *2016 International Conference on Global Trends in Signal Processing, Information Computing and Communication (ICGTSPICC)* (IEEE, 2016), pp. 122–125
38. S. Nisha, S.P. Balakannan, An energy efficient self organizing multicast routing protocol for internet of things, in *2017 IEEE International Conference on Intelligent Techniques in Control, Optimization and Signal Processing (INCOS)* (IEEE, 2017), pp. 1–5
39. S.S. Chaudhari, S. Maurya, V.K. Jain, MAEER: mobility aware energy efficient routing protocol for internet of things
40. T. Behera, U.C. Samal, S. Mohapatra, Energy efficient modified LEACH protocol for IoT application. *IET Wirel. Sens. Syst.* (2018)
41. F.K. Shaikh, S. Zeadally, E. Exposito, Enabling technologies for green internet of things. *IEEE Syst. J.* **11**(2), 983–994 (2017)

42. L.O. Varga, G. Romaniello, M. Vučinić, M. Favre, A. Banciu, R. Guizzetti, C. Planat et al., GreenNet: an energy-harvesting IP-enabled wireless sensor network. *IEEE Internet Things J.* **2**(5), 412–426 (2015)
43. A.S.H. Abdul-Qawy, T. Srinivasulu, EH-mulSEP: energy-harvesting enabled multi-level SEP protocol for IoT-based heterogeneous WSNs, in *2017 3rd International Conference on Applied and Theoretical Computing and Communication Technology (iCATccT)* (IEEE, 2017), pp. 143–151
44. C. Mahapatra, Z. Sheng, V.C. Leung, Energy-efficient and distributed data-aware clustering protocol for the internet-of-things, in *2016 IEEE Canadian Conference on Electrical and Computer Engineering (CCECE)* (IEEE, 2016), pp. 1–5
45. Y. Liu, Q. Chen, G. Liu, H. Liu, Q. Yang, EcoSense: a hardware approach to on-demand sensing in the internet of things. *IEEE Commun. Mag.* **54**(12), 37–43 (2016)
46. L. Rosyidi, R.F. Sari, Energy harvesting aware protocol for 802.11-based internet of things network, in *2016 IEEE Region 10 Conference (TENCON)* (IEEE, 2016), pp. 1325–1328
47. M. Magno, F.A. Aoudia, M. Gautier, O. Berder, L. Benini, WULoRa: an energy efficient IoT end-node for energy harvesting and heterogeneous communication, in *Proceedings of the Conference on Design, Automation & Test in Europe* (European Design and Automation Association, 2017), pp. 1532–1537
48. Z. Yang, W. Xu, Y. Pan, C. Pan, M. Chen, Energy efficient resource allocation in machine-to-machine communications with multiple access and energy harvesting for IoT. *IEEE Internet Things J.* 1–1, 2017

An Architecture for the Real-Time Data Stream Monitoring in IoT



Mario José Diván and María Laura Sánchez Reynoso

Abstract The IoT allows a new kind of monitoring strategy based on the heterogeneity of the devices and its lower cost. It implies a challenge in terms of the data interoperability and the associated semantic when they must support the real-time decision making. In this chapter, an integrated and interdisciplinary view of the data processing in the heterogeneous contexts is presented at the light of the Processing Architecture based on Measurement Metadata (PAbMM). The processing architecture gathers the data stream processing with the batch processing related to the Big Data repositories under the umbrella of the measurement projects. Thus, the integration between the measurement and evaluation (M&E) framework and the real-time processing is detailed. Followed, the interoperability is addressed from the M&E project definitions and the data interchanging related to PAbMM. The decision-making support is strengthened by a similarity mechanism which allows looking for similar experiences when a given situation lack of a specific knowledge. Finally, an application of the processing architecture based on Arduino technology for the “Bajo Giuliani” (La Pampa, Argentina) lagoon monitoring is shown.

Keywords Data stream · Measurement · Real-Time processing · Internet of thing · Big data

1 Introduction

The evolution of the communications and the Internet have allowed the integration of different kind of services and infrastructures. From the active web pages, passing through the social networks and mobile devices to the real-time data consuming,

M. J. Diván (✉) · M. L. Sánchez Reynoso
Economics and Law School, National University of La Pampa, Coronel Gil 353. 1st Floor,
6300 Santa Rosa, Argentina
e-mail: mjdivan@eco.unlpam.edu.ar

M. L. Sánchez Reynoso
e-mail: mlsanchezreynoso@eco.unlpam.edu.ar

© Springer Nature Singapore Pte Ltd. 2020
S. Tanwar et al. (eds.), *Multimedia Big Data Computing for IoT Applications*, Intelligent Systems Reference Library 163,
https://doi.org/10.1007/978-981-13-8759-3_3

they are today the current coin in a world dominated by the communication and the information systems [1]. In this context, the data are continuously generated under different kinds of formats and following a specific underlying model.

Nowell, along with the data generation process, it is possible to differentiate at least between the real-time data and historical data. On the one hand, the real-time data are consumed as close as possible to the generation instant, and the life cycle is limited to the arrival of new data (i.e. the new data implies the substitution and updating of the previous data, allowing describing an updated situation). On the other hand, the historical data are consumed at any moment and they are oriented to characterize a given historical situation, conceptualizing the idea of “historical” such as a captured past event in relation to the current time (e.g. the past five minutes). The real-time and historical data are useful in its own context, that is to say, the real-time data are mainly oriented to the active monitoring of an entity under analysis (e.g. an outpatient, the environment, etc.), while the historical data are associated with the non-critical information systems in where there exists tolerance in relation to the answer time and its processing.

In this sense, the data source is understood such as an integrable component (physical or not) with a given precision and accuracy, able to generate data under a particular organization from a given entity. The entity represents any concept able to be analyzed through a set of measurable characteristics (be abstract characteristics or not). Thus, the idea of data source could be matched with different kinds of physical sensors, or even a software measuring specific aspects of other software.

The configuration possibilities associated with each data source are very wide and it depends on the specific application, and for that reason, the likelihood to find heterogeneous data sources is very high. For example, it could be possible to measure the water temperature using a digital thermometer, or by mean of a thermometer based on mercury. In both cases, the measured value could be similar, however, the data organization for informing the current data, the accuracy and precision could be different.

Another important aspect in relation to the data sources is its autonomy, that is to say, each data source sends the captured and observed data from its own entity under analysis, and no one external entity could affect or interrupt its internal behavior. Continuing the example of the water temperature, the thermometer informs the value of the measured temperature from the water following a given technique, but this is independent of other devices. This is important to highlight because a data processor is not able to affect or modify the expected behavior from the data sources, it just can receive and process the sent data from the data source.

Thus, the basic idea of data source could be defined as an integrable component, heterogeneous, with a given precision and accuracy, susceptible to be calibrated, autonomous in terms of the measurement technique and the measure production, with basic interaction capacities limited to the coordinating of the data sending.

The evolution of the data sources converges today in the idea associated with the Internet of Thing [2]. Before defining it, it is important to say that by “things” is understood that data source able to interact by wireless connections with other devices, conforming, integrating or scaling new services. Thus, the Internet of Thing

could be defined such as the autonomous capacity related to a set of pervasive “things” connected through wirelesses, which is able to integrate, extend or support new kind of services by mean of the interaction among them. In this kind of environment, the things could be heterogeneous, and for that reason, the data interchanging requires a common understanding which fosters the interoperability from the syntactic and semantic point of view.

In this way, the data could be continuously generated from different environments and any time, which implies a rapid growing of the volume and variety of data. In the case of the data should be stored, it gives place to a big data repository. In effect, the three Big Data V’s implies velocity, variety, and volume. The volume of data is associated with the huge of collected data from the devices which must be permanently stored. The variety refers to the kind of data to be stored, queried and processed coming from the devices (e.g. a picture, information geographic, etc.). Finally, the velocity refers to the growth projection of the Big Data repository in relation to the incoming data.

The Big Data repositories could be as big as possible, but they are finite. That is to say, they may incorporate a lot of data, but always the volume is quantifiable and determined. The last is a key difference in relation to the real-time data collecting and processing, because, for example, the sensors are permanently sending data, the data are useful at the generation instant and the volume of the data just could be estimated but not determined.

In other words, the size of a Big Data repository could be computed, but the size of a data flow is not limited. This is a key difference between the Big Data and the real-time data processing approach. For example, it supposes that a user needs to match their customers with its geographic information for putting the customer information on a map. Both the customer and the information geographic corresponds with a finite set, with a given size, in where the sets could be analyzed and processed for obtaining the wished results. The results can be ordered in absolute terms because the result set is finite too. However, if the user wants to merge the share prices from New York with Tokyo for a given stock, the resulting is continuously updated with each new data and the final size is not determined. Even, the order in which the resulting could be sent to the user is relative because such order is limited to the currently processed data.

1.1 The Data Stream Environment

One of the main aspects to consider in this new communicated world is the usefulness of the data stream and what is the advantage in relation to the persistent data strategy. In this sense, it is necessary to say that the stored data are inadequate when the data is oriented to the active monitoring. That is to say, the time for the data retrieving from a persistent device is upper than the required time for processing them at the moment in which they arrive. The idea of the data stream is associated with the data

processing exactly when they have arrived. Thus, they are ideally read one time, because a new reading would simply lose the opportunity to read the new data.

The data stream could be defined in terms of Chaudhry [3] such as an unbounded data sequence. In addition, it is important to incorporate that the data sequence could have a data organization and the order in each sequence is relative only to a given sequence. For this reason, the definition could be updated and extended saying that the data stream is an unbounded data sequence in where the data could be structured under a given data model and the order of each datum is relative to its own sequence.

The real-time data and its associated processing, present key differences in relation to the data stored in a Big Data repository, which can be synthesized in at least three: time notion, reliability, and reaction. In the data stream, the data are processed at the moment in which they arrive, they push the old data (updating them), and the data are processed as they are, be reliable or not. Even, the data stream incorporates the notion of time in its own generation chronology. However, a Big Data repository does not necessarily incorporate the notion of time, the data must be queried, and because they are able to be analyzed and controlled, they have an upper level of reliability.

The data stream itself could be characterized by Chakravarthy and Jiang [4]:

- **The arriving:** The data elements arrive in a continuous way, keeping a relative order to the sequence itself,
- **The notion of time:** The idea of time is incorporated, be in the underlying data model or in the sequence,
- **The Data Origin:** The data source is associated with the data stream (e.g. a temperature sensor), that is to say, the data origin is unmodifiable by any data processor,
- **The input from the data stream:** It is unpredictable in terms of rate or volume of data,
- **The Data Model:** Each data stream could have its own underlying data model or not (e.g. it could be semi-structured such as an XML document, or not structured like a text file),
- **Data Reliability:** The data inside of the data stream are processed like they are, they are not free of errors because depend on the data source and the transited path,

For boarding the data stream processing, the idea of “window” was proposed. Basically, a window is a logical concept associated with some kind of partition of the original data stream for making easier the partial data processing. Synthetically, it is possible to define a window in terms of a given magnitude of time (physical window), for example, the window keeps the data related to ten minutes. In addition, it is possible to define a window in terms of a given quantity of data (logical window), for example, one hundred messages from the data source. Nowell, when the logical or physical window implies to keep static the width and update its content based on a notion of time (the new data replace to the old data), the window is known as a sliding window. For example, the last five minutes (sliding physical window), the last one hundred messages (sliding logical window), etc.

1.2 The Big Data Environment

The Big Data is a term which describes a huge of data, following a data model, which continuously overflow with data to the organization. The processing strategy is thought for batch processing, fostering the parallelization strategy, on the base on a given requesting (On-demand).

As it was introduced before, the original three “V” of the Big Data is associated with variety, volume, and velocity. The variety implies that the data contained inside the repositories are associated with different kinds (e.g. associative, relational, audio, etc.). The volume refers to the huge of data available in the repository for processing and analysis. The Velocity concept is associated with the increasing rate of the data in relation to the repository and its sizing.

Even more, the variability of the provided data is a current concern in the discipline, because the data coming from independent data sources (such as the data streams) could incorporate inconsistent data in the repository. In addition, the processing complexity is incremented from the heterogeneity of the underlying data models and the diversity of kind of data.

An additional “V” was proposed in relation to the value of the data and its importance for the decision-making process. That is to say, the idea of value refers to the capacity of obtaining new information through some kind of processing from the stored data in a repository. This gives a start to the idea of data monetization, in other words, the way to make money by using the data available on the repository [5].

However, the four mentioned “V” are not the only “V” because Khan et al. [6] proposed another “V” as complement, such as (i) *Veracity*: it refers to the trust respect the data when it needs to be used for supporting the decision making, (ii) *Viscosity*: it is associated with the level of relationship among complex data (cohesion and dependence), (iii) *Variability*: it is related to the inconsistent data flow which takes a special interest in the measurement projects, (iv) *Volatility*: it is associated with the data lifecycle and its necessity of being stored, (v) *Viability*: it is related which the time where the data is useful for generating new information, and (vi) *Validity*: It refers to the fitted and compatible data for a given application.

The idea associated with the NoSQL database simply refers to “Not only SQL” in relation to the databases. That is to say, the NoSQL databases are oriented to implement a different data model to the relational data model. There are at least four basic NoSQL data model related to the Big Data repositories [7]: (i) *The Wide-Column Data Model*: the data are organized in terms of tables, but the columns become to a column family, being it fully dynamic aspect. The atomicity principle is not applied here such as the relational model, and for that reason the content is heterogeneous. Even, the structure between rows (e.g. the quantity of columns) is not necessarily the same. (ii) *The Key-Value Data Model*: It looks like a big hash table where the key allows identifying a position which contains a given value. The value is a byte flow, and for that reason, it represents anything expressible like byte stream (e.g. picture, video, etc.), (iii) *The Graph Data Model*: each node represents a data unit, and the arcs with a given sense implement the relationships among them,

and (iv) *Document-oriented Data Model*: The data are hierarchically organized, and they are free of a schema. Each stored value is associated with a given key, being possible to store the data formats such as JSON, XML, among others.

Because the uses and applications of the NoSQL databases do not necessarily have a transactional target [8], the ACID (Atomicity, Consistency, Isolation, and Durability) principle is not critical or mandatory to consider. Thus, the BASE (Basically Available, Soft State, and Eventually Consistent) principle is better fitted in NoSQL databases [9]. In this sense, basically available implies that the answer is guaranteed even when the data are obsolete. The Soft State refers to the data are always available for receiving any kind of changing or updating. Finally, eventually consistent implies that given the distributed nature of the nodes, the global data as a unit will be in some instant consistent.

Even when the data stream and the Big Data environment have different kinds of requirements in terms of the available resources, data organization, processing strategy and, data analysis, they could be complementary. That is to say, in case of having that to store a data representative quantity from a data stream, the ideal kind of repository for managing a massive dump of data is precisely a Big Data repository because allows keeping the stability and scalability at the same time.

1.3 Main Contributions

As contributions of this chapter: (i) *An Integrated and Interdisciplinary View of the Data Processing in the Heterogeneous Contexts is presented*: An integrated perspective under the figure of a processing architecture based on measurement metadata, which includes from the heterogeneous data sources (e.g. Internet of things) to the real-time decision making based on the recommendations (i.e. knowledge and previous experiences). The fully-updated main processes are detailed using the Business Process Model and Notation (BPMN)¹; (ii) *The integration between the measurement and evaluation framework and the real-time processing is detailed*: In a data-driven decision-making context, the concept monitoring and the real-time data processing are a key aspect. In this sense, the importance of the measurement and evaluation project definition in relation to the data processing (be it online or batch) is introduced and exemplified; (iii) *The Interoperability as the axis of the Processing Architecture*: Because of the data sources are heterogeneous, the Measurement Interchange Schema (MIS) is introduced jointly with its associated library, as a strategy for the data integration of different kinds of devices. Even, the project definition schema based on the measurement and evaluation framework is highlighted in terms of its importance for the interoperability among the different measurement systems; and (iv) *The similarity as a recommending strategy improves the decision-making support*: Because of some monitored concept could do not have previous experiences or knowledge, a strategy oriented to the similarity-based searching is proposed for the

¹<http://www.bpmn.org>.

organizational memory. Thus, the idea is found the experiences as close as possible to a given situation for a complementary recommending. This allows a better support to the decision-making process in presence of the uncertainty.

1.4 An Outline of the Rest of the Chapter

Thus, having introduced important aspects related to the Big Data Repositories and NoSQL databases, jointly with the underlying concepts to the data streams and the Internet of Thing, in the following sections an overview of the proposal for the integral boarding of the real-time monitoring applied in the measurement and evaluation area is synthesized. Section 2 presents a synthesis associated with the data stream management system. Section 3 describes the basic steps for defining a measurement and evaluation project. Section 4 introduces the measurement interchange schema. Section 5 outlines the Processing Architecture based on Measurement Metadata. Section 6 describes the main processes related to the Processing Architecture in terms of the Business Process Model and Notation (BPMN). Section 7 introduces an application case for an integral boarding of the measurement and evaluation project. Section 8 outlines some related works. Finally, Sect. 9 presents some conclusions and future trends related to the area.

2 The Data Stream Management System

The Data Stream Processing (DSP) could be viewed as a programming paradigm oriented to the transformation or change in any form of the data continuously arriving through one or more data sources [10]. Returning to the concept of data stream introduced before, the data stream is an unbounded data sequence in where the data could be structured under a given data model and the order of each datum is relative to its own sequence. Thus, the Data Stream Management System (DSMS) could be defined as the software responsible for the implementing of the data stream processing, considering from the data sources, the data transformation to the output managing.

Each operation applied to a given data on a data stream is defined through an operator which is able to transform, change and/or replicate in any form the data stream. The operations applied to the data stream can be pipelined following a given order defined by an application. This pipeline allows connecting the operations and their results with the aim of building a global pipelining system of data, connecting each data source with the expected outputs. Thus, the data stream applications exploit the parallelism given by the pipelines, taking advantage of the common hardware for scalability and the infrastructure economy [11].

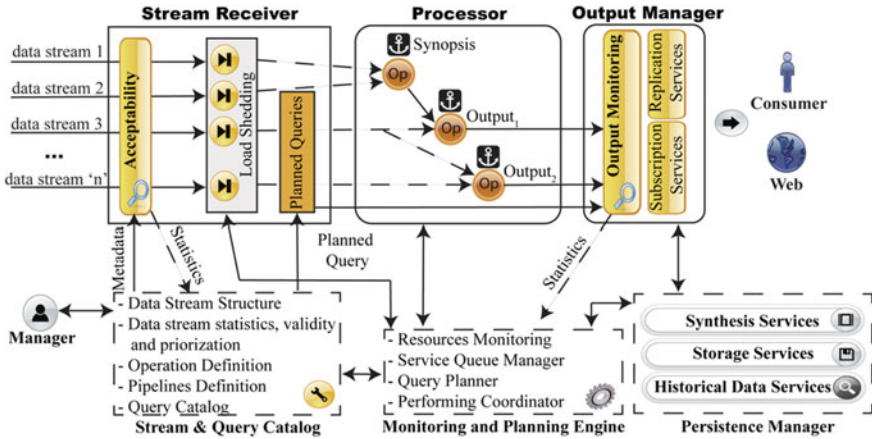

Fig. 1 The architectural view of the data stream management system

In this sense and for keeping simple the idea of the data stream management system, it is possible to see them as responsible for keeping flowing the data inside each pipeline, avoiding the obstruction and giving the outputs in terms of each connection (the intermediate operations). Figure 1 exposes an architectural view of the data stream management system, which is organized around five main components: the stream and query catalog, monitoring and planning engine, persistence manager, stream receiver, the processor itself, and output manager.

The stream and query catalog (see Fig. 1, on the left lower angle) is basically responsible for: (i) *The data stream structure definition*: It is associated with the structural definition of each data stream to be consumed by the stream receiver; (ii) *The data stream statistics*: It represents the collecting of the arrival rate, data volume, among others aspects necessities for the query planner and the managing of each data stream; (iii) *The data stream validity*: It defines the data stream to be accepted along with a given time period; (iv) *The data stream prioritization*: It establishes the prioritization to be considered for the data stream receiving and processing in case of the resources are committed; (v) *The operation definition*: It is responsible for defining the inputs, the transformation or associated procedure jointly with the expected operation outputs; (vi) *Pipelines definition*: It establishes the way in which the operations and data streams are connected, and (vii) *Query Catalog*: It registers the set of the planned queries for the data streams or intermediate results.

The Monitoring and Planning Engine (see Fig. 1, on the middle lower region) is responsible for: (i) *The resources monitoring*: The main responsibility is the real-time monitoring associated with the pipelines, planned queries and ad hoc queries. This allows warranting enough resources for generating the expected outputs; (ii) *The Service Queue Manager*: It is responsible for the ordering of the operations in the runtime environment, considering the available resources; (iii) *The query planner*: From the statistics related to the data streams, the available resources, and the

associated definitions, it is responsible for the organization of the query plan and its communication to the service queue manager; (iv) *The performing coordinator*: From the real-time information provided by the resource monitoring and the query planner, it is responsible for launching and warranting the running of each operation from the beginning to the end.

The Persistence Manager (see Fig. 1, on the right lower angle) is responsible for the storing of the data following the indicated synthesis strategy, but just when it is required. That is to say, this component is optional and could be out of the bundle of a given data stream management system. When the persistence manager is incorporated as component inside the data stream management system, the main responsibilities are associated with: (i) *The synthesis services*: it describes the strategy for identifying the data to be kept in a persistent way from the real-time data stream, (ii) *The storage services*: It is responsible for establishing the necessary channels for storing and retrieving the data from the external storage unit; and (iii) *The historical data services*: This service is responsible for the query plan optimization, retrieving, and the output organization from a given external query on the historical data.

Thus, the Stream Receiver (see Fig. 1, on the left upper angle) is who determines whether a data stream is accepted or not, using the defined metadata in the data stream catalog. In this sense, a data stream could be correctly defined, but its life period is not valid (e.g. it has expired). All the defined data streams with a valid time period are monitored for collecting statistics. The statistics are sent for its posterior use in the planners (e.g. the query planner). Once the statistics were collected, the data streams pass through a load shedder. The load shedder discards in a selective way the data, keeping those considered as important in base on its definition. The use of the load shedding techniques is optional, and they are applicable when the available resources are near to the maximum limit. Once the data stream has got out from the load shedder, the output could directly go to an operation, or well, it could be used in a planned query. In the case of a planned query, the output could be directly sent to the output manager or even to another operation.

The processor (see Fig. 1, on the middle upper region) is who keep flowing the data from the data stream, passing through the operations to the output manager [12, 13]. It is responsible for the real-time computing, implementing of the pipelines, data transformation, and the communication of the results to the output manager. An interesting thing incorporated on each operation is the idea of the synopsis. The synopsis is an in-memory materialized operation result who kept the last known result for the associated operation. This materialized result is useful for continuing the processing with the posterior operations, even when the inputs of the origin operation were interrupted.

The Output Manager (see Fig. 1, on the right upper angle) regulates the way in which the outputs are communicated jointly with its monitoring (e.g. the output rate). The output (i.e. the result associated with a pipeline, planned query or ad hoc query) could be replicated to other sites or systems, but also, it could be directly consumed by mean of a set of users or systems. In this sense and on the one hand, *the replication service* is responsible for automatically serving the outputs to the configured systems or users. On the other hand, *the subscription service* regulates

the target associated with the consumers of each stream and the valid life cycle in which they could consume each output.

The Internet of Thing, Data Streams, Big Data and Data Stream Management Systems are converging in application joint areas, such as the healthcare [14] among other areas. That is to say, the Internet of Thing (IoT) allows boarding the data collection with different kind of devices, communicating they between them and transmitting different kinds of data (e.g. from information geographic to pictures). On the one hand, the collected data from the different “Things” could be stored in case of necessity, which considering that the data streams are potentially unbounded will give origin to a Big Data Repository. On the other hand, when the data coming from the “Things” should be processed when they arrive, it is necessary for the incorporation of the DSMS. Thus, The IoT, Big Data and the DSMS allow the implementing of the measurement process as a strategy for knowing and monitoring the current state of some concept under interest [15].

3 The Measurement and Evaluation Project Definition

The way in which the person naturally knows the state or situation of an object is through the measurement, for example, when a child goes to the periodical medical visit, the doctor checks its size, height, weight, among other aspects comparing all of them with the previous medical visit. In this sense, measuring and comparing the current and past values, the doctor could determine its evolution. Even when this could seem to be as an elemental thing, the measurement involves a set of details which are critical at the time in that the values should be obtained, compared and evaluated.

Figure 2 shows a simple case in where the child and an adult person are walking in the park. In such a situation, it is necessary to monitor the child temperature for determining whether the child has a fever or not. The child is considered like the entity under monitoring, while the park is considered as the context in where the entity is immersed. Because the presence of fever is related to the corporal temperature, it is considered as an attribute able to be quantified, and for that reason, to be monitored. The way in which a given value is obtained for a particular attribute is known as a metric. In addition, the metric involves the specification of the particular method to be used, jointly with the unit, scales, etc. Thus, the metric uses a device for obtaining the measure; that is to say, in this situation the thermometer is used for obtaining the value (e.g. 38.3 °C). The obtained value is known as the measure. Once the value is obtained, the measurement reaches to its end, and the next stage is associated with the value interpretation. There, it is necessary the knowledge from the domain experts, which is incorporated in the indicators in the form of the decision criteria. Thus, using the indicators with the incorporated decision criteria, the evaluation could conclude about the presence of fever or not on the child. What if the next day the corporal temperature is obtained from the child’s mouth using the same thermometer? The new measure would not be comparable with the previous temperature because the

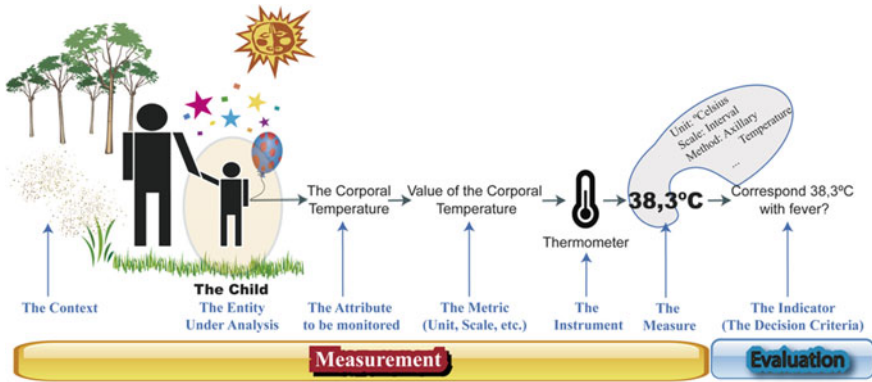

Fig. 2 A conceptual view of the measurement process

method has been changed, the previous day used the axillary temperature, while the new value is obtained from the mouth.

The measurement process is a key asset for reaching a predictable performance in the processes, and it incorporates the assumptions of the repeatability, comparability of the results, and extensibility [16]. That is to say, (i) the *repeatability* is the possibility of applying in an autonomous and successive way the same measurement process, independently of the person/machine responsible for the application itself; (ii) the *comparability of the results* implies that the values are homogeneous and obtained following the same method and using compatible instruments for its implementing; and (iii) the *extensibility* refers to the possibility of extending the measurement process when there are new requirements.

The measurement and evaluation frameworks allow defining the measurement process with the aim of guarantying the repeatability of the process, the comparability of the associated results and its extensibility when there are new requirements [17]. There are many examples from traditional approaches such as The Goal-Question-Metric paradigm [18], passing through the C-INCAMI (acronym for Context-Information Need, Concept Model, Attribute, Metric, and Indicator) [19, 20] framework, to most recent approach such as the “Agg-Evict” framework [17] oriented to the network measurement.

Thus, the repeatability of the measurement process implies a common understanding related to the underlying concepts (e.g. metric, measure, assessment, etc.), which is essential for its automatization, for example, through the IoT as the data collectors and the DSMS as the data processor.

The original version of the C-INCAMI framework established the concepts, terms and the relationships necessities for defining and implementing a measurement project [19]. Followed to the original version, the idea of measurement context was incorporated [20] for explicating the idea of the mutual incidence between the entity under analysis and the context in which it is immersed. To the effects of the project

definition, this chapter is based on a variant of the C-INCAMI framework [21], which allows jointly incorporating:

- The idea of estimated and deterministic measure,
- The incorporation of the complementary data related to each measure. The complementary data could be a picture, video, audio, plain text, and/or information geographic,
- The managing of the data sources and the associated constraints,
- The organization and use of the measurement adapter,
- Diverse ways to check the content integrity (e.g. be it at message or measure level), and
- The possibility of carrying forward the data traceability,

The C-INCAMI framework is guided by an information need, which allows establishing the entity under analysis and describing the attributes who characterize it. Each attribute is associated with a metric, who is responsible for its quantification. The metric defines the method, scale, unit, the associated instrument (i.e. the data source) among other aspects for obtaining and comparing the measure. Each metric could obtain a set of measures. The measure represents a specific value obtained by mean of the metric, at a specific time. The measure alone does not say much, but the role of the indicator allows interpreting each measure through the incorporation of the decision criteria. For example, given a temperature obtained from a metric, the indicator (through the decision criteria) allows knowing whether a child suffers fever or not (see Fig. 2).

The way in which a measurement and evaluation project could be formally defined using the C-INCAMI framework is defined in [22], and just a few basic steps are requested: (i) *The definition of the non-functional requirements*: it is responsible for establishing the information need related to the project and the identification of the entity category (e.g. a lagoon, a person, etc.), the entity to monitor (e.g. John Doe) and the attributes for quantifying it; (ii) *Designing the Measurement*: Once the entity is defined and their attributes identified, the metric is defined for each attribute jointly with its association with the data source (e.g. a given sensor in IoT); (iii) *Implementing of the Measurement*: The measurement is effectively activated through the different sensors associated with each metric and the measures start to arrive for its processing; (iv) *Designing the Evaluation*: The indicators and the associated decision criteria are defined for interpreting each measure from the metrics; (v) *Implementing of the Evaluation*: The indicators, decision criteria, and the decision-making is effectively put to work through an automatized process; and (vi) *Analyzing and Recommending*: It is responsible for analyzing each decision from the indicators and to give some recommendations pertinent to the configured situation.

The “Bajo Giuliani” is a lagoon located around 10 km at the south of the Santa Rosa city, province of La Pampa in Argentina (South-America). On the south shore of the lagoon, there is a neighborhood named “La Cuesta del Sur”. This lagoon receives water from the raining and waterways coming from the city. On the lagoon, the national route number 35 cross it from the north to south. For clarifying the idea associated with the project definition, the basic steps are exemplified. Thus, the

project's information need could be defined as "*Monitor the level of water of the 'Bajo Giuliani' lagoon for avoiding flood on the south shore related to the neighborhood*". The entity category is defined such as "*lagoon located in the province of La Pampa*", principally considering the particularities of this region and the semi-arid climate. The entity under analysis or monitoring is limited to the "*Bajo Giuliani*" lagoon. Nowell, the attributes to choose should characterize the lagoon in relation to the defined information need. For that reason, it is chosen: (i) The water temperature: It allows determining the possibilities of the evaporation in relation to the lagoon; (ii) The ground moisture: it facilitates identifies the regions in which the water advance on the south shore and the regions in which the water is retreating; and (iii) The water level: It allows determining the variation of the water level between the floor of the national route number 35 (it is crossing the lagoon) and the south shore floor related to the neighborhood. In relation to the context, the environmental temperature and humidity are considered for analyzing the effect of the evaporation and the risk of fog on the national route respectively. Even, a picture would be a good idea like complementary datum, principally considering the aspects related to the fog, evaporation, and the environmental temperature.

It is important to highlight that the number of attributes for describing to an entity under analysis jointly with the number of the context properties for characterizing the related context is arbitrarily defined by the analyst responsible for the measurement process. In this case and following the principle of parsimony, these attributes and context properties are kept for exemplifying the idea and the associated applications along this chapter.

Once the attributes and context properties are known and clearly limited, the definition of each metric associated with them is necessary for its quantification. In this sense, the definition of each metric allows specifying the ID associated with the metric, the kind of metric, the associated scale (i.e. kind of scale, the domain of values and the unit), and the associated method. The method describes its name (this is important when it is standardized), the kind of measurement method (i.e. objective or not), a brief narrative specification and the instrument to be used for effectively getting the measure (or value). This step is critical because here it is possible to define whether the expected measure will be deterministic or not.

Table 1 shows an example of the definition for the metric related to the water temperature attribute based on the entity under analysis "The Bajo Giuliani Lagoon". Because the result associated with a metric is a value or likelihood distribution, the given name for a metric starts with "Value of ...". Even when the metric gives a likelihood distribution, the estimated value (e.g. the mathematics expectation) is a unique value. The defined metric is direct because the value is obtained using an instrument, and not by derivation from other values of metrics (in this case would be indirect). The scale associated with temperature is Interval, the domain of values is numeric, each value belongs to the set of the Reals, and the expected unit is the Celsius degree. The method describes the way in which each value is effectively obtained. In this case, the water temperature gets by immersion and contact direct, using an objective method through the sensor Ds18b20 mounted on the Arduino One board.

Table 1 An example of the definition for the metric related to the water temperature attribute

Metric	ID: 1 Name: <i>value of the water temperature</i>
Kind	<i>Direct metric</i>
Scale	<ul style="list-style-type: none"> • Kind: <i>Interval</i> • The domain of Values: <i>Numeric, Real</i> • Unit: <i>°Celsius</i>
Method	<ul style="list-style-type: none"> • Name: <i>Submerged by direct contact</i> • Measurement method: <i>objective</i> • Specification: <i>It takes the water temperature in the specific position where the monitoring station based on the Arduino One is located. The water temperature is taken at least around 5 cm under the level of the water surface</i> • Instrument: <i>Sensor Ds18b20 (Waterproof) mounted on the Arduino One board</i> • Kind of values: <i>Deterministic</i>

Table 2 An example of the definition for the metric related to the environmental humidity context property

Metric	ID: 2 Name: <i>Value of the environmental humidity</i>
Kind	<i>Direct metric</i>
Scale	<ul style="list-style-type: none"> • Kind: <i>Interval</i> • The domain of Values: <i>Numeric, $x \in \mathbb{R}_0^+ / x \leq 100$</i> • Unit: <i>% (Percentage)</i>
Method	<ul style="list-style-type: none"> • Name: <i>Direct exposition to the environment</i> • Measurement method: <i>objective</i> • Specification: <i>It takes the environmental humidity in the specific position where the monitoring station based on the Arduino One is located. The environmental humidity is taken at least around 2 m above the level of the floor related to the south shore of the neighborhood</i> • Instrument: <i>The DHT11 humidity sensor mounted on the Arduino one board</i> • Kind of values: <i>Deterministic</i>

Table 2 shows an example of the definition for the metric related to the environmental humidity (a context property) for the defined context in relation to the “Bajo Giuliani Lagoon”. The metric receives the ID 2 for differentiating from other metrics (i.e. a unique identification) jointly with a specific name “Value of the environmental humidity”. This metric is direct because it does not depend on the values of other metrics. The scale is an interval, the domain of values is defined to the set of the real limited to the closed interval $[0; 100]$, and there is not a unit, because the expected value is a percentage (i.e. it is relative). The method for getting the value is objective and based on the direct exposition to the environment. The sensor who obtains the value is the DHT11 mounted on the Arduino One board, and the expected position of the sensor is above 2 m above the floor of the neighborhood south shore.

As it is possible to appreciate between Tables 1 and 2, the definition of a metric has no difference whether it is a context property or an attribute, because the context property is really an attribute. However, the context property is conceptually specialized for describing a characteristic of the entity context.

Thus, the defined metrics for the entity attributes and the context properties allows obtaining a value, be it deterministic or not. Nowell, the interpretation of each value is an aspect associated with the indicator definition. In this sense, the conceptual differentiation between metric and indicator is that the metric obtains the value, and the indicator interprets each value from a given metric.

Each indicator has an ID which allows its unique identification along the project. Because the indicators are associated with the interpretation, the common name starts with “Level of...”, in where the interpreted value is related to one or more metrics. It is possible to have two kinds of indicators: Elementary or Global. On the one hand, the elementary indicator allows interpreting in a direct way the value from a formula, which establishes the relationship among a set of metrics. The global indicator allows obtaining its value from the values associated with a set of elementary indicators, and in this case, the weight is used for pondering each elementary indicator value. Table 3 shows an example of the indicator definition associated with environmental humidity. The indicator named “Level of the environmental temperature” is identified by “I2” and it is an elementary indicator. For that reason, the associated metric is in this case $Metric_{ID_2}$ (i.e. The value of the environmental humidity) and the formula expresses that the decision criteria uses the value such the metric provides (i.e. without conversion or transformation). Because the number of indicators is not limited, it is possible to have as many indicators as be necessary. For example, it could be possible to have an indicator for expressing the level of variation of the environmental humidity using a formula such as $Metric_{ID_2}(t)/Metric_{ID_2}(t - 1)$. The conversion or transformation of the metric value is not mandatory, but many times is used for expressing transformations or for linking a set of metrics. Thus, once the formula value is obtained, the decision criteria incorporate the knowledge from the experts for interpreting each value, and for example, when the value of the environmental humidity is 96%, the decision criterium using the Table 3 will say “Very High” and will indicate a specific action to do. The Kind of answer based on the interpretation is defined as a categoric value and with an ordinal scale limited to the following values “Very High”, “High”, “Normal”, “Regular”, and “Low” in that order. When some interpretation has an associated action, the interpreter is responsible for performing it. It is important to highlight that the action to do is based on the decision criteria defined by the experts in the specific domain, and it is not related to a particular consideration of the interpreter.

Following this same mechanic, all the necessary indicators associated with the “Bajo Giuliani lagoon” can be defined. Thus, on the one hand, the measurement is implemented through the definitions of the metrics who are responsible for obtaining the measures (i.e. the values). On the other hand, the evaluation is implemented through the indicators who are responsible for the interpretation of each value from the metric and the guiding of their derived actions.

The CINCAMI/Project Definition (synthetically, CINCAMI/PD) [23] is a schema based on the C-INCAMI extended framework which allows interchanging the definition of the measurement and evaluation project among different systems. It has an

Table 3 An example of the definition for the indicator related to the environmental humidity context property

Indicator	ID: I2 Name: <i>Level of the value of the environmental humidity</i>		
Kind/weight	<i>Elementary indicator</i> Weight: 1		
Reference metrics	Metric _{ID2} (i.e. Value of the environmental humidity)		
Model	<ul style="list-style-type: none"> • Kind: <i>Ordinal</i> • Domain of values: $x \subset \{VeryHigh, High, Normal, Regular, Low\}$ • Unit: <i>Not applicable</i> 		
Formula	=Metric _{ID2}		
Decision criteria	Interval	Interpretation	Actions
	[95%; 100%]	Very high	Notify
	[80%; 95%)	High	Notify
	[60%; 80%)	Normal	No action
	[40%; 60%)	Regular	No action
	[0%; 40%]	Low	No action

open source library available on GitHub² for generating and reading the definitions, fostering its interoperability along different kind of systems who need to implement the measurement based on the extended C-INCAMI framework.

Thus, before to board the data stream processing based on the measurement meta-data, the next section introduces the measurement interchange schema for demonstrating how the measurement stream can be generated based on the project definition.

4 The Measurement Interchange Schema

Once the Measurement and Evaluation Project is defined, the definition is communicated to the data processing systems jointly with the measurement adapter. The measurement adapter is a role associated with the responsibility for translating the raw data coming from the sensors to a given data format. For example, the data are obtained from the sensors mounted on the Arduino One. The Arduino One takes the raw data and transforms them in a message based on the eXtensible Markup Language (XML)³ or JavaScript Object Notation (JSON)⁴ to be sent to the data processor.

As it was shown before, the measurement and evaluation project definition allow defining the attributes and context properties for an entity, jointly with the associated

²<https://github.com/mjdivan/cincampid>.

³<https://www.w3.org/XML/>.

⁴<https://www.json.org>.

metrics. Thus, the measurement adapter and the data processor could interpret a given message using the definition.

Nowell, when the measurement adapter receives the project definition, it associates each sensor value with the expected metric, and in this line, the new messages will be organized using the project definition known as the metadata. In the same sense, the data processor will interpret each message coming from the measurement adapter using the same project definition. This is a key asset because both the sender and receiver share a common project definition for fostering the data interoperability.

The Measurement Interchange Schema (MIS) [21] is structured following the underlying concepts, terms and the relationships associated with the extended CINCAMI framework, and it is also known under the name of CINCAMI/MIS. The schema allows the measurement interchanging using as guide the project definition. Thus, a CINCAMI/MIS message incorporates the data (i.e. the measures) jointly with the metadata (e.g. the identification of a metric for a given measure) which allow guiding the real-time data processing.

4.1 The Details About the Measurement Schema

The Measurement Interchange Schema is hierarchically organized through an XML schema following the concepts, terms, and relationships associated with the measurement and evaluation project definition.

In the hierarchical organization of the schema (see Fig. 3), It is possible to find three kind of symbols: (a) **A**: it represents that it is possible to have a set of the lower tags in any order. For example, under the *measurementItemSet* tag, it is possible to find a set of the *measurementItem* tag in any order; (b) **S**: it refers to a specific order in relation to the set of the lower tags. For example, under the *measurementItem* tag, it will find the *idEntity*, *Measurement*, and *context* tags in that specific order; (c) **C**: it indicates that just one lower tag can be chosen from all the detailed lower tags.

Thus, Fig. 3 outline the highest level related to the measurement interchange schema. The *CINCAMI_MIS* tag limits the message for a given measurement adapter. That is to say, each set of measures coming from the same measurement adapter at a given time, it will be organized under the same *CINCAMI_MIS* tag. This tag has two associated attributes, the *version* refers to the version of the measurement schema used in the message, while the *dsAdapterID* refers to the unique identification of the measurement adapter which acts as the intermediary between the data sources (i.e. the sensors) and the data processor.

The measures are grouped through the *measurementItemSet* tag, which contains a set of *measurementItem* tag. The *measurementItem* tag represents one measure associated with its contextual information and complementary data. This tag identifies (1) The data source ID (i.e. the *dataSourceID* tag) which is the identification of the data source that acts as the origin of the measures; (2) The original data format in which the data source provides the measure to the measurement adapter. For example, and using the Table 1, it would be the data format in that the sensor

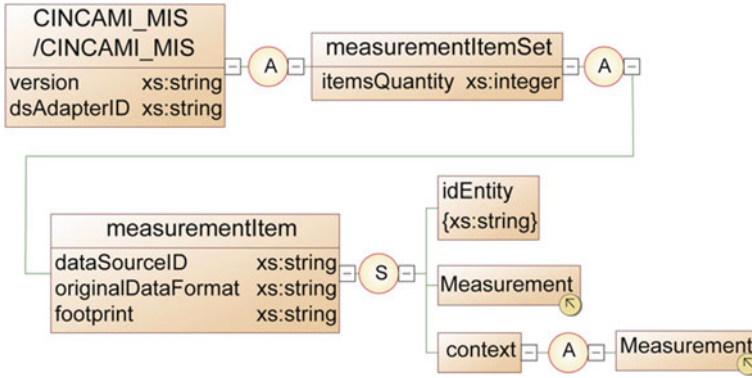

Fig. 3 The upper level of the CINCAMI/MIS message

Ds18b20 informs each measure to the Arduino One in which it is mounted; and (3) The footprint allows an integrity verification on the informed measure, considering the measurement itself jointly with the context information. In addition to the measure and the context information, the *measurementItem* tag allows identifying the entity under monitoring, which is useful in case of the load shedding techniques and data prioritization in the real-time data processing.

The yellow circle with an arrow inside represents a direct access to the definition for avoiding the redundancy. For example, Fig. 3 indicates that the structure of the *Measurement* tag under the *measurementItem* and *Context* tags respectively are the same. Indeed, the *Measurement* tag is shown in Fig. 4, and it has three associated tags: *datetime*, *idMetric* and *Measure*. The *datetime* tag refers to the instant in which the measure is got. The *idMetric* tag refers to the metric in the project definition for the entity under analysis with who the measure is associated. Finally, the *Measure* tag describes the structure related to the measure itself.

Under the *Measurement* tag there exists the description of the quantitative value jointly with the complementary data. The quantitative value could be estimated or deterministic and for that reason, just one of the two tags must be chosen. On the one hand, the deterministic value has a unique value which represents the quantification of the indicated metric (i.e. *idMetric* tag) for the given entity (i.e. *IdEntity* tag) at the specific time. On the other hand, the likelihood distribution is represented such as a set of the estimated tags. Thus, each *estimated* tag is an estimated value described by the (value, likelihood) pair.

The *Measurement* tag introduced in Fig. 3 is extended in Fig. 4; while the complementary data introduced in Fig. 4 are detailed in Fig. 5.

Thus, Fig. 5 details the alternatives for the complementary data related to a given measure. As it is possible to appreciate in Fig. 5, under the *complementaryData* tag is possible to find a set of the *complementaryDatum* tag. Each complementary datum must be one of five alternatives: (i) A document organized under the Geography

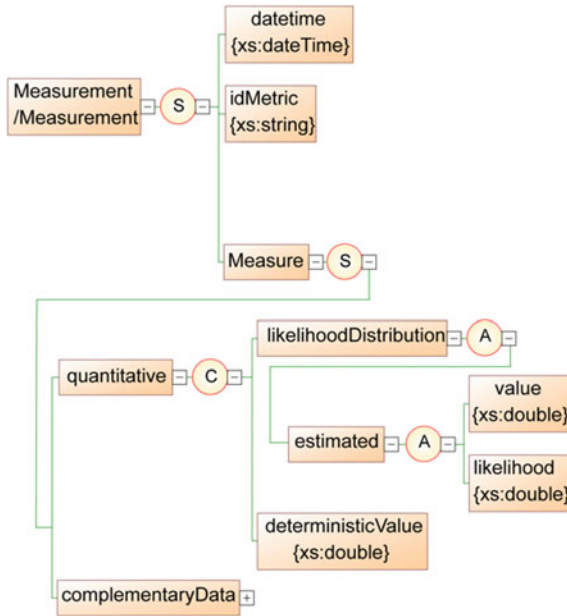

Fig. 4 The measurement tag in the CINCAMI/MIS message

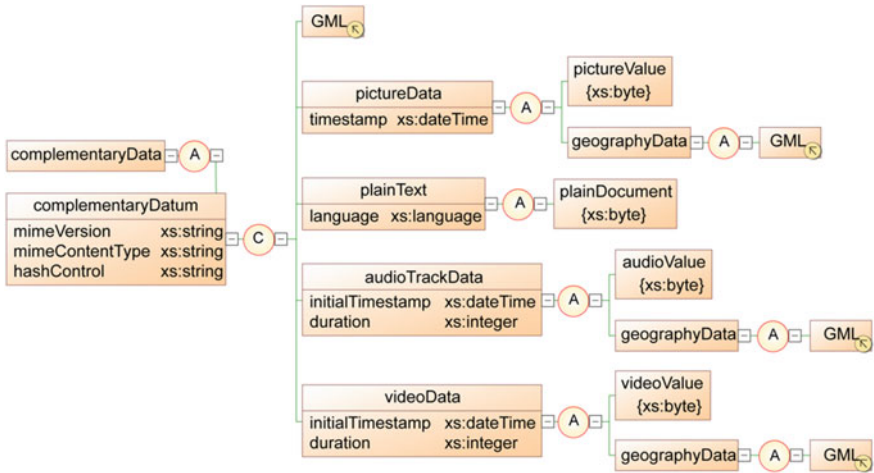

Fig. 5 The complementary data organization in the CINCAMI/MIS message

Markup Language (GML)⁵; (ii) A picture describing the context or some characteristic of the entity under analysis; (iii) A plain text which is possible to be associated with a system log; (iv) An audio track representative of some attribute or context property related to the entity or its context respectively; and (v) A video file which could describe some interesting aspect of the region.

Each complementary datum could be associated with a GML document for describing the specific location. This is useful when the audio, picture or video file should be related to a particular localization. Moreover, the geographic information could be linked in relation to a measure without the necessity to have an associated audio, picture or video file. That is to say, the incorporation of the geographic information does not require the mandatory use of the multimedia files to be included as a complementary datum for a given measure. In this sense, each measure could have complementary data (i.e. it is optional), and in that case, the set could be integrated by one or more complementary datum without a specific limit.

In this way, the CINCAMI/Measurement Interchange Schema allows coordinating the meaning and data organization based on the extended C-INCAMI framework, jointly with the project definition. This fosters the data interoperability between the involved processing systems and the data sources, because the data generation, consuming, and the processing itself are guided by the metadata (i.e. the project definition). For example, the Arduino One receives the project definition by mean of a CINCAMI/PD message, and thus, it knows the range of expected values from the sensor DHT11 (environmental humidity). Then, a value such as 120 could be detected as not valid in the measurement adapter by mean of the direct contact with the data source (DHT11 sensor), just using the metric definition (see Table 2). When this happens, it could be possible to send an alarm to the data processor and discard the anomalous value avoiding overhead from the source.

4.2 *The CINCAMIMIS Library*

The CINCAMIMIS library is an open source library, freely available on GitHub⁶ for using in any kind of systems which require the measurement automatization based on the extended C-INCAMI framework. The library was developed in the Java 8 language, using Google gson⁷ jointly with JAXB libraries.

The library allows generating the measurement streams under the CINCAMI/MIS for being interchanged among the processing systems, the data sources and the processing system, or even the data sources with each other (e.g. in IoT). Thus, the measurement interchange schema fosters the data interoperability independently of the processing systems (be it a data consumer or producer) and the software used for carrying forward the project definition.

⁵<http://www.opengeospatial.org/standards/gml>.

⁶<https://github.com/mjdivan/cincamimis>.

⁷<https://github.com/google/gson>.

Both XML as JSON data formats are supported for making as easy as possible the data interchanging. Complementarily, the GZIP compression can be used on the XML/JSON messages for minimizing the interchanged data and the required time for the communication.

The library implements a translating mechanism which allows transparently migrating among XML, JSON, the object model in any sense. The Object Model is completely based on the extended C-INCAMI framework, a reason why the concepts and terms able to be processed are completely known.

5 An Architectural View for the Measurement Processing

The Processing Architecture based on Measurement Metadata (PAbMM) is a data stream engine encapsulated inside a Storm Topology. It allows carrying forward the data-driven decision making based on the real-time monitoring of one or more measurement and evaluation projects [24].

From the architectural view, it could be analyzed from four functional perspectives: (a) *The Definition*: It is responsible for the measurement and evaluation project definition. The result of this perspective is a CINCAMI/PD file used as input in the architecture; (b) *The Data Collecting and Adapting*: The Data Collecting and Adapting: it is responsible to implement from the data collecting on the sensors to the consolidated data receiving for its central processing; (c) *The Analysis and Smoothing*: It allows carrying forward a series of statistical analysis on the data stream for detecting anomalies, deviations or unexpected behavior in terms of the typical data distribution; and (d) *The Decision Making*: In case of some situation is detected, it is responsible for making a decision based on the experience and previous knowledge available on the organizational memory. The four perspectives are synthetically described through the BPMN notation in the next section.

Initially, each measurement and evaluation project is defined by the domain's expert, who establishes the information need, it defined the entity under analysis, the associated attributes, the context properties, the metrics useful for their quantification, among other aspects (see Sect. 3). Once the M&E project is ready, this is communicated to the PAbMM using the CINCAMI/PD schema and the definition is incorporated in the organizational memory (see Fig. 6). Thus, when PAbMM receives the CINCAMI/PD file, it is simultaneously informed to each in-memory component, being ready for processing a new data stream.

As it is possible to see in Fig. 6, the Measurement Adapter (MA in Fig. 6) has a morphology like a star. That is to say, each extreme of the star represents a given data source (e.g. a sensor) communicated with the measurement adapter located on the center. Each sensor could be heterogeneous, and for that reason, it is possible that the MA receives the data organized in a different way (a typical aspect in IoT).

Using the project definition file (i.e. the CINCAMI/PD file associated with a given project) in the configuration stage, the MA identifies and knows each related sensor,

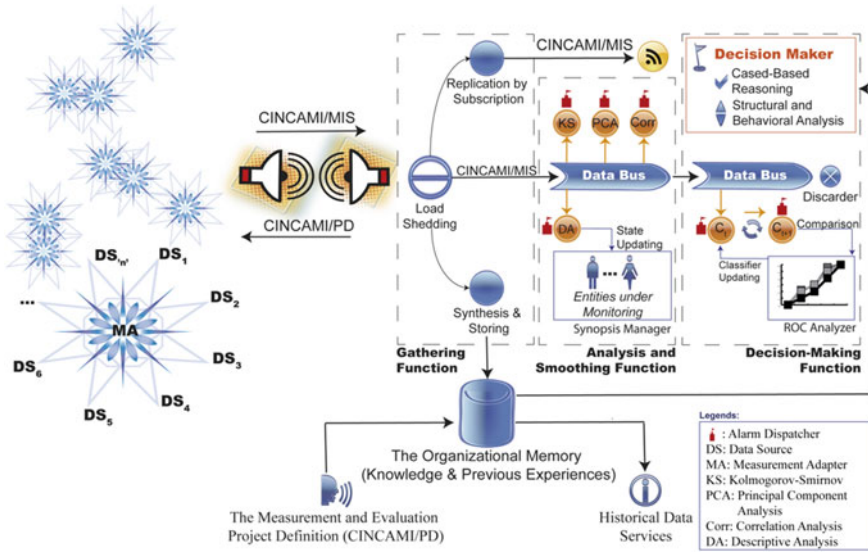

Fig. 6 The architectural view for the measurement processing

its associated metric, the quantified attribute or context property, and the entity under analysis.

Synthetically, the MA receives the data organized in a heterogeneous way from each sensor. From there, this is responsible to identify each sensor, verify the obtained measure in terms of the project definition (e.g. for detecting miscalibration), and to make the necessary transformations for sending the measures as a unique CINCAMI/MIS stream.

It is important to remark that each CINCAMI/MIS stream jointly inform the measures and the associated metadata. Thus, the Gathering Function responsible for receiving the data streams guides the processing using the metadata and the associated project definition (e.g. using the CINCAMI/PD file).

The Gathering Function (see Fig. 6) receives the data stream and it applies the load shedding techniques when it is necessary. The load shedding techniques allow a selective discard of the data for minimizing the loose when the arrival rate is upper than the processing rate [25]. Whether the load shedding techniques be applied or not, the resulting stream organized under the CINCAMI/MIS (i.e. the data organization coming from the MA) is automatically replicated to (i) *The subscribers*: Each one who needs to read the data stream without any kind of modification could be subscribed it (e.g. it could be made using Apache Kafka⁸); (ii) *The Synthesis and Storing Functionality*: it represents a kind of filter for the data stream, which acts before to store the content with the aim of synthesizing it. The synthesizes algorithm is optional, and for that reason, a data stream could be fully stored if no

⁸<https://kafka.apache.org>.

one algorithm was indicated. For example, in the monitoring of the environmental temperature related to the “Bajo Giuliani” lagoon, it would be possible to store a synthesis of the environmental temperature every five minutes (e.g. one value) if no change in it happens. In terms of storing, it would be an interesting optimization of its capacity; (iii) *The Analysis and Smoothing Function*: It is responsible for the real-time statistical analysis of the data stream.

When the data stream is received in the Analysis and Smoothing Function, it canalizes the data through a common data bus. From the common data bus a set of analysis are simultaneously computed: (i) *The Kolmogorov-Smirnov through the Anderson-Darling test* [26]: it allows analyzing the data distribution in relation to the expected behavior (e.g. detecting normality when it is present); (ii) *The Principal Component Analysis*: This analysis is useful for detecting the variability source, mainly thinking in aspects that could get out of control the expected behavior for a given attribute; (iii) *The Correlation Analysis*: It is carried forward for analyzing the dependence and relationships between the involved variables in the entity monitoring (i.e. a metric could be viewed such as a variable), and (iv) *The Descriptive Analysis*: it allows updating the descriptive measures related to each attribute and context property of each entity. In this way, the last known state is gradually built. Even, from the last known state, an idea of synopsis could be used for answering in an approximate way when the data source related to an entity has been interrupted. As it is possible to see in Fig. 6, some circles have an associated flag but not all. The circles with an associated flag represent that the related operation can launch an alarm when some atypical situation is detected (based on the project definition). For example, when the descriptive analysis is processing the value of the environmental temperature (i.e. a metric’s value, the measure) in the “Bajo Giuliani” lagoon, a temperature upper than 50 °C is atypical for the region, and it could be indicating a fire.

At the same time in which the data are statistically processed, they continue its travel to the decision-making function. In the decision-making function, a current classifier (see C_t in Fig. 6) based on the Hoeffding Tree is applied from the known situations [27]. For example, in the case of the “Bajo Giuliani” lagoon, the known situations could be the fire, flood, etc. In parallel, the original classifier is incrementally updated with the new data, resulting in a new Tree (see C_{t+1} in Fig. 6) for who a new classification is obtained. Both classifiers are compared based on the area under the ROC (Receiver Operative Curve) curve [25], and the classifier with the biggest area will be the new “current classifier”. However, and as it is possible to see in Fig. 6, the classifiers could launch an alarm when some critical situation is detected (e.g. a flood). In any case, the alarm receiver is the decision maker component in the decision-making function.

When the decision maker receives an alarm (be it from the statistical analysis or the classifiers), it looks in the near history related to the entity under analysis for similar situations and its associated recommendations. When the situations and recommendations are found, the recommended actions are performed (e.g. notify to the fire station). However, it is highly possible that some entity has not a recent associated story. In such case, a case-based reasoning based on the organizational

memory is carry forward supported by the structural and behavioral coefficients. On the one hand, the structural coefficient allows identifying the entities who share the similar structure for the monitoring. On the other hand, the behavioral coefficient allows identifying the entities who experiment a similar. Both coefficients, structural and behavioral, allows filtering the in-memory organizational memory for limiting the search space and improving the performance of the case-based reasoning.

As it is possible to appreciate, the architectural view considers from the project definition, passing through the data collecting (i.e. by mean of the IoT sensors) and adapting (i.e. the measurement adapter) and ending with the real-time decision making and the associated recommendations. The next section introduces the process formalization for the Architectural View related to the measurement processing.

6 The Formalization Related to the Architectural View

The Architectural View of the Measurement Processing is substantiated around five main processes: (i) *The configuration and startup*: It is responsible for the initialization of the processing architecture, from the loading of each project definition to the start of the data receiving; (ii) *The collecting and adapting*: It is oriented to warranty the data collecting from the sensors, the needed transformations from the raw data and the delivering to the GF of the data stream; (iii) *The Data Gathering*: It is responsible for the data gathering coming from the measurement adapters, jointly with the data replications and synthesis when it is required; (iv) *Data Analysis and Smoothing*: It performs the real-time data analysis based on the M&E project definition, being responsible for the building and keeping of the synopsis in memory; and (v) *Decision making*: It receives the alarms thrown from the different processes, and it is responsible for determining the necessity of notification based on the priority, informing the actions and the associated recommendations. Following, each process is synthetically explained using the BPMN notation for better understanding.

6.1 The Configuration and Startup Process

Before the processing architecture can process anything, the M&E project definition must be loaded in memory and initialized. As was introduced in Sect. 3, the project definition establishes the information need, the entity under analysis, the attributes used for characterizes the entity, the context properties useful for detailing the context in which the entity is immersed, among other concepts and terms. The loading activity implies read each CINCAMI/PD content from the files or web services, validate it and prepared the data structure and buffer for receiving the data.

This process incorporates the capacity of starting-up the processing architecture, stop its functioning and make the online updating of the project definition (see Fig. 7). When the startup process of the architecture is initialized, three different threads are

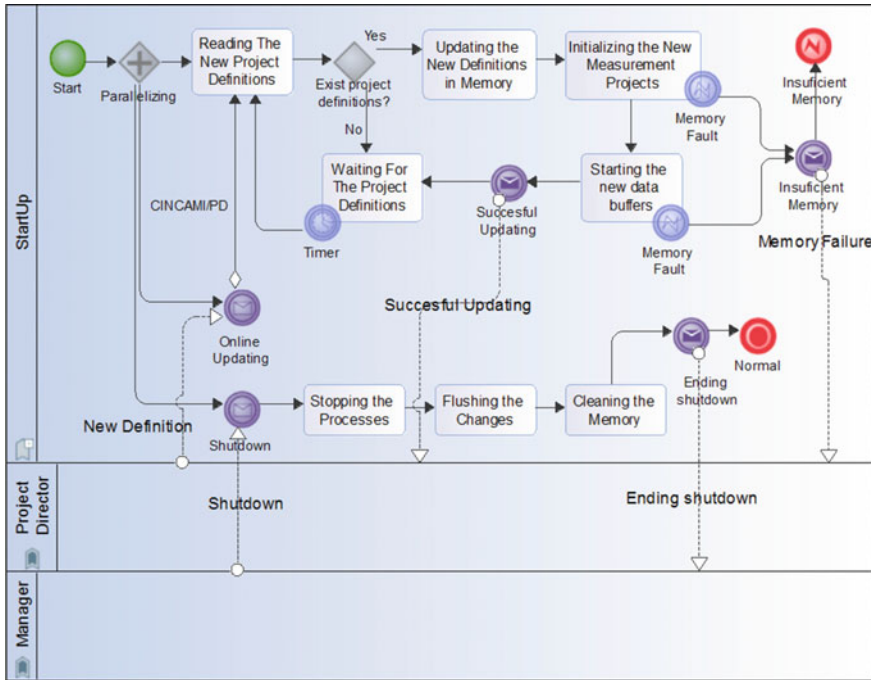

Fig. 7 The configuration and startup process using BPMN notation

generated: (i) *The project definition loader*, (ii) *The updating listener*, and (iii) *The Power-off performer*.

The thread associated with the project definition loader is located in the superior region of Fig. 7, and it starts with the reading of the project definitions. In the beginning, the M&E project definitions are read from the organizational memory related to the PAbMM (see Fig. 6). Each project definition is organized following the CINCAMI/PD schema, which allows using any kind of software for carrying forward the project specification.

Once the definitions were read, the architecture counts them and in case of there not exists definitions, the architecture keeps waiting for new definitions. The waiting time could be specified as an architecture parameter. However, when at least one definition is present, it is updated in memory indicating the entity, the expected attributes, and the associated metrics jointly with the expected values, among other aspects indicated in the definition. If there is not enough memory during the initialization, a fault is thrown, and an abnormal end state is reached.

After the project initializing, the data buffers are created and reserved specifically for the M&E project. Thus, the memory space for the data stream, the synopses and the partial results derived from the statistical analysis are ready for the processing. Thus, a message indicating the “Successful” updating is sent to the project director,

and the architecture finally comes back to the waiting state waiting for new definitions (be it new projects or updating).

The thread related to the online updating just implies a task continuously waiting for a message from the project director. When the project director sends a CINCAMI/PD document through a web service to the process by mean of the “Online Updating” message, the architecture migrates the new definition to the project definition loader for starting its loading as was explained before. In this case, and on the one hand, when the successful loading of the new definition is made, the project director receives a message indicating it. On the other hand, and when some memory failure happens, an error message is communicated to the project director too.

The power-off is simple but quite different because it implies the stopping of the data processors, the cleaning and freeing of memory. The manager is the only role able to carry forward the shutdown. Thus, when the manager sends the shutdown signal, the message is received and immediately the data processors are stopped. Next, any transitory results are stored on the disk for finally cleaning all the memory (data structures and buffers). When the cleaning has ended, the architecture sends a message to the manager committing the shutdown.

It is clear that this process is dependent on the project definition, and for that reason, there is not any processing in absence of the project definition. This is a key asset because it allows highlighting the importance of the metadata (i.e. the entity, attributes, metrics, etc.) at the moment in which each data should be processed. Having said that, it is possible to highlight that all of the other processes directly depend on the configuration and startup process.

6.2 The Collecting and Adapting Process

The collecting and adapting process is carried forward on the measurement adapter. The measurement adapter is a piece of the architecture located on portable devices (see Fig. 6). This process is responsible for communicating an M&E project definition to the measurement adapter, for establishing the relationships among the available sensors and each metric indicated in the project (see Fig. 8).

As it is shown in Fig. 8, the process could carry forward a new project definition, an updating or even the power-off of the measurement adapter. In this sense, it is important to highlight that the power-off is specifically limited on one measurement adapter and not all the processing architecture. Thus, a set of sensors could be interrupted through the power-off of its associated measurement adapter, while other measurement adapters continue sending data to the gathering function.

The project definition is entered by mean of a CINCAMI/PD definition. The definition could be obtained from: (a) a file, (b) the organizational memory or, (c) by the web services related to the architecture (see Fig. 6). In the case of the CINCAMI/PD definition is locally stored on the measurement adapter, the project loader directly starts with the loading when power-on the device. Thus, a matching between sensor and metrics based on the project definition using the metadata (see Tables 1 and 2)

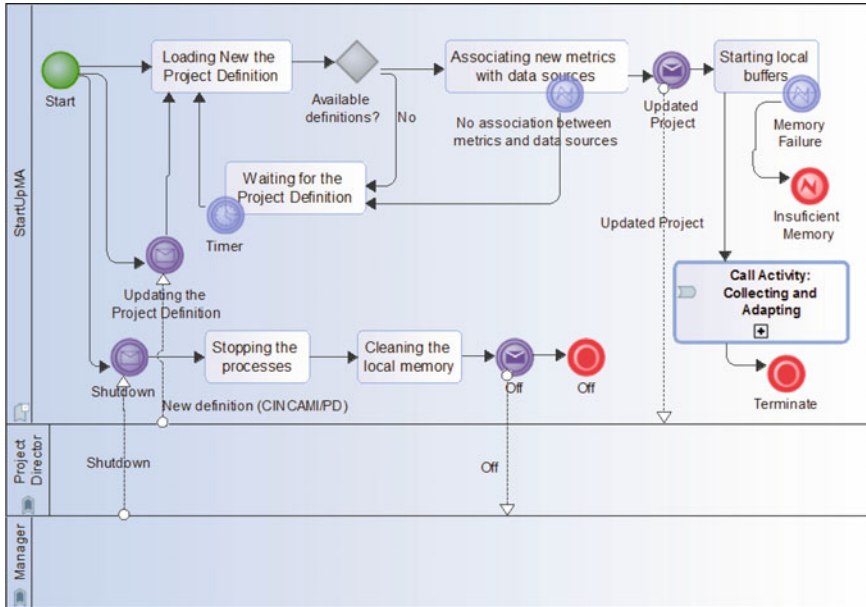

Fig. 8 The collecting and adapting process using BPMN notation

is automatically made. In the case of all the metrics are correctly associated with the sensor, the buffers are initialized, and the data collecting is immediately started.

However, in case of some metric keeps without association, it provokes that the measurement adapter transits to wait for a new M&E project definition. This allows defining a norm such as: “A measurement adapter will initialize an M&E project definition if and only if all the included metrics have an associated sensor in the measurement adapter; else the definition is not appropriated”. In other words, a measurement adapter could have more sensors than metrics, but a metric must have an associated sensor.

In addition, the project director could update the definition sending a new definition to the measurement adapter. The measurement adapter receives the new definition, validate it (e.g. the content and the association between sensors and metrics), starts the new buffers in parallel for instantly replacing the previous definition. Next, the data collecting is continued based on the new definition.

In this case, just the manager role is able to shut down the measurement adapter. Because the measurement adapter is a component located on a portable device, the shutdown implies stop the data collecting thread, clean the memory and power-off the device. Figure 9 synthetically describes the steps for the data collecting. The sensors have a passive behavior, due to which the measurement adapter collect the data from the sensors and put the data inside the data buffer. The data are put in the buffer in the same way that they were obtained (be it such as a raw data or in the proprietary data format).

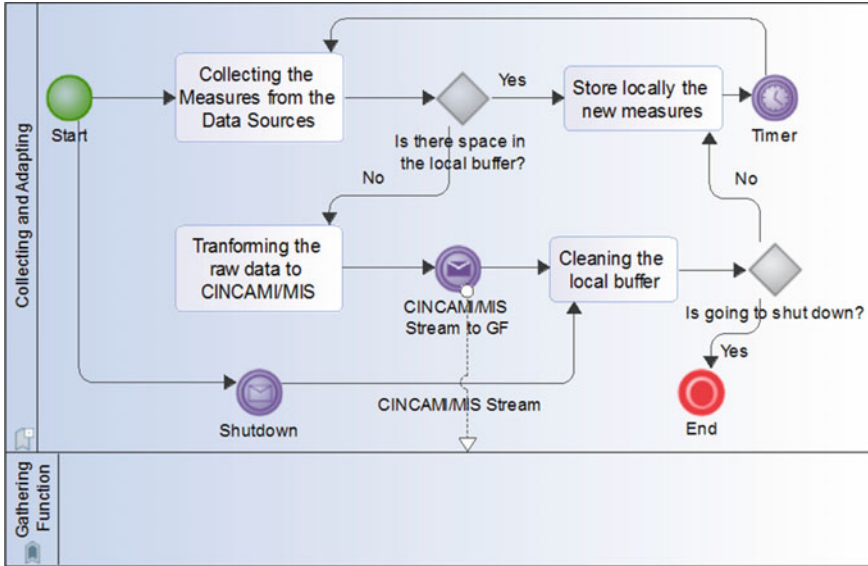

Fig. 9 Details on the collecting activity for the collecting and adapting process using BPMN notation

Once the data buffer becomes full, the measurement adapter generates the CINCAMI/MIS stream guided by the project definition. The data stream is sent to the gathering function, after which the buffer is cleaned for continuing the data collection.

This process depends on the “*Configuration and Startup*” process because the project definition is needed, and the gathering function should be operative for receiving the collected data from the measurement adapters.

6.3 The Data Gathering Process

The Gathering Process is responsible for the data gathering coming from the measurement adapters, jointly with the data replications and synthesis when it is required. Once the processing architecture has been initialized and the measurement adapters too, the gathering function incorporates a passive behavior. That is to say, each measurement adapter sends the measurement stream when it needs, and for each request, the processing architecture will give course to the respective processing.

Figure 10 represents the start point with the reception of the message from the measurement adapter (see Fig. 9). When the CINCAMI/MIS stream has come, the gathering function evaluates the content in terms of the measurement adapter validity (e.g. the measurement adapter must be identified in the CINCAMI/MIS message, see Fig. 3). If the received measurement stream corresponds with a blocked measurement

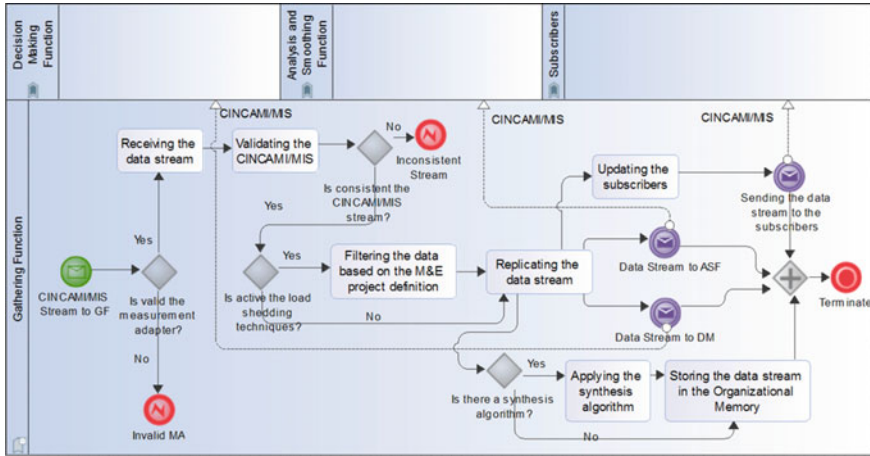

Fig. 10 The data gathering process using BPMN notation

adapter (i.e. the measurement adapter is kept out from the collecting schema by a given reason), the message is discarded, and the process instantiation is derived to the end state, indicating that the message is invalid for its processing.

However, when the informed message from the measurement adapter corresponds with an active adapter, the next step is associated with the consistency verification related to the message itself. Thus, the message is effectively read and received, and then, the schema validation is carried forward. In the case of the stream does not satisfy the CINCAMI/MIS schema, the process instantiation is derived to the end state indicated as “Inconsistent Stream”.

Thus, all the streams which satisfying the measurement interchange schema (i.e. CINCAMI/MIS) are derived for the application of the load shedding techniques. The load shedding techniques allow a selective discarding based on the content stream and the M&E project definition. This kind of optional techniques is automatically activated when the arriving rate is upper to the processing rate. Because the measurement interchange schema is completely based on the M&E project definition, it is possible to retain in a selective way the priority measures.

Once the measurement stream has passed through the load shedding techniques, the resulting measures are replicated. The replication happens to four different destinations: (a) *The subscribers*: It requires a previous registration for continuously receiving the measurement stream without any modification; (b) *The Analysis and Smoothing Function*: a copy of the current measurement stream is sent for the real-time statistical analysis; (c) *The Decision-Making Function*: a copy of the current measurement stream is derived for analyzing whether corresponds with some typical situation or not (e.g. fire, flood, etc.); and (d) *Historical Data*: Basically the measurement is directly stored in the organizational memory for future use. However, when the synthesis data option is enabled, the measurement stream is processed through a determined synthesis algorithm which internally determines what kind of data must

be retained and stored. For example, it is possible to continuously receive the temperature data from the “Bajo Giuliani” shore, but maybe, it could be interesting just keep the temperature’s changes in persistence way.

Thus, when the measurement stream has been derived by mean of the four channels (i.e. the subscribers, analysis and smoothing function, decision-making function and the organizational memory), the process comes to its end.

6.4 The Analysis and Smoothing Process

The Analysis and Smoothing Process performs the real-time data analysis based on the M&E project definition, being responsible for the building and keeping of the synopsis in memory.

This process performs five statistical analysis in parallel at the moment in which the measurement streams come from the gathering function (see Fig. 11): (i) The Descriptive Analysis (DA), (ii) The Principal Component Analysis (PCA), (iii) The Data Distribution Analysis (DDA), (iv) The Analysis of the Outliers (AO), and (v) The Correlation Analysis.

The Descriptive Analysis allows checking each measure in terms of the project definition, and at the same time, carry forward the updating of the descriptive measures (i.e. mean, variance, etc.) for each metric related to a given entity under analysis. In this sense, when the descriptive analysis obtains a value inconsistent with the

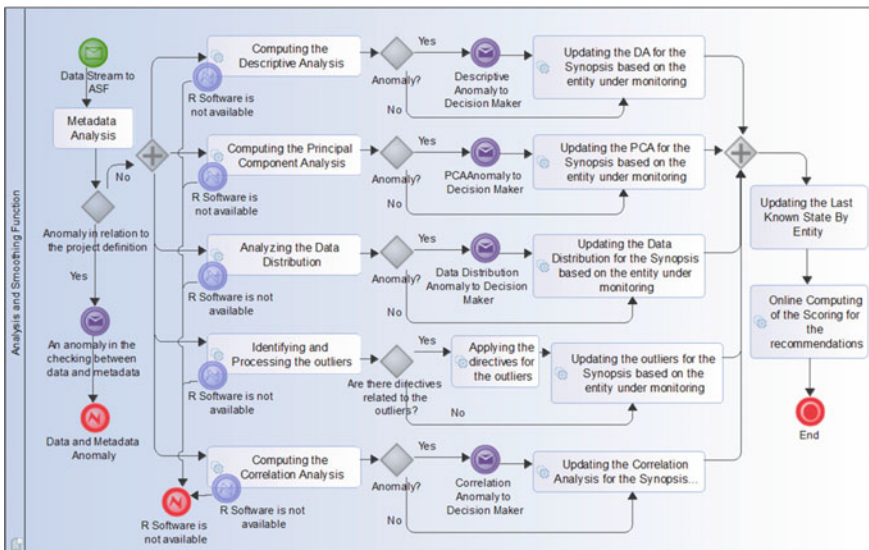

Fig. 11 The analysis and smoothing process using BPMN notation

project definition (e.g. an environmental temperature with a value of 200), an alarm is sent to the Decision Maker. Whether the alarm is thrown or not, the computed descriptive measures for each metric allows updating the synopsis related to the entity under monitoring. Thus, by mean of the synopses, the processing architecture could partially answer the state of an entity in front of a given query, even when the associated measurement adapter has been interrupted.

The Principal Component Analysis is carried forward for evaluating the contribution to the system variability of each metric in the context of the M&E project. When some metric (i.e. or random variable in this context) is identified as big variance contributor, an alarm is thrown to the decision maker for analyzing it. Whether the alarm is thrown or not, the PCA analysis allows updating the synopsis related to each associated entity under monitoring.

The Data Distribution Analysis carries forward the Anderson-Darling test for analyzing the data distribution in terms of the previous data distribution for the same metric. When some variation is detected, an alarm is thrown to the decision maker. Continuously the data distribution information is updated in the synopsis for enabling the future comparison in terms of the new data arriving.

The Analysis of the Outliers is continuously performed for each metric and entity under analysis. When some outlier is detected, an alarm is thrown to the decision maker. The decision maker will determine the importance and priority of each alarm. The outlier information is continuously updated in the synopsis for comparing the behavior in relation to the data distribution.

The Correlation Analysis allows analyzing the relationships between the metrics, be they attributes, or context properties related to a given entity under analysis. Thus, it is important to verify the independence assumptions among the variables (i.e. the metrics), but also for possibly detecting new relationships unknown before.

Finally, all the information coming from each analysis is updated in the last known state by the entity, which allows carrying forward the online computing of the scoring for the recommendations. That is to say, with each new data coming through the measurement stream for a given entity, the recommendations are continuously reordered in terms of the pertinence in relation to the new data. Thus, when some alarm is thrown for a given entity, the scoring corresponds with the last data situation for the associated entity. This avoids an additional computation for the decision making when it needs to incorporate recommendations jointly to the actions for a given alarm.

6.5 The Decision-Making Process

The Decision-Making Process receives the data and alarms from the different processes (i.e. The Gathering Function and Statistical and Smoothing). It is responsible for determining the necessity of notification based on the priority, informing the actions and the associated recommendations.

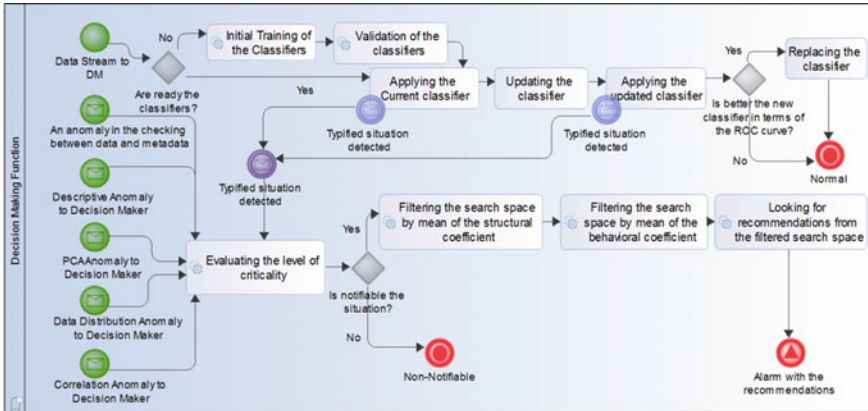

Fig. 12 The decision-making process using BPMN notation

Figure 12 shows the different kinds of start point related to the process. The basic start (circle without any image) is started when a new measurement stream is received from the gathering function. In that situation, if the classifiers are not trained, then they are trained just one time by the mean of the training set contained in the organizational memory.

Once the classifiers are trained, each new data is classified by the current classifier. Next, the classifier is updated with the new data, and the data is reclassified using the updated classifier. Both classifiers are compared by mean of a ROC curve. When the updated classifier contains an area under the curve upper than the current classifier, the updated classifier becomes in the new current classifier, replacing it. It is important to highlight that in case of the current or updated classifier give a classification related to a typified situation which is considered critical (e.g. fire, flood, etc.), the process is directly derived for evaluating the level of criticality.

The rest of the start points of this process correspond with alarms thrown from the statistical and smoothing function. All the start points related to a message implies that the anomaly or alarm was detected, and in this process, the criticality analysis should be made.

The level of the criticality is taken from the decision criteria contained in the indicators jointly with the organizational memory, who contains the previous experience and knowledge. Thus, and on the one hand, when the situation is an alarm in where the notification is not required, it is discarded. On the other hand, when the alarm requires notification, the search spacing of the organizational memory (a Big Data Repository) is filtered looking for the associated recommendations, and finally, the external alarm is sent with the actions and associated recommendations (e.g. the steps to follow in a given situation).

Because the organizational memory is a big data repository, the strategy is to keep in memory the most used region. For that reason, the scoring is permanently updated on each new data. In addition, the structural coefficient allows looking for entities

which share attributes for its quantification. However, a most strict limitation could be carried forward using the entities with a similar structure, but also with similar behavior for each monitored attribute [28]. In this sense, when there are not recommendations for a given entity, it is possible to find recommendations coming from similar entities for avoiding send an alarm without recommendations. For example, the “Bajo Giuliani” lagoon is a new entity under analysis and there is not associated history. However, in case of fire, the previous experience related to other lagoons, could be used for driving the steps in an emergency.

7 An Application Case Using the Arduino Technology

In this application case, the processing architecture based on measurement metadata is applied to the real-time lagoon monitoring. In this case, the application is associated with the “Bajo Giuliani” lagoon. What is special with the “Bajo Giuliani” Lagoon? It is a natural reservoir of water, located 10 km at the south of the Santa Rosa city (the capital of the province of La Pampa, Argentina), in South America. The lagoon receives the water from the rain and the waterways who bring the derived water from the Santa Rosa city.

The lagoon is crossed by two routes, the national route number 35 from south to north, and the provincial route number 14 from west to east. Both routes are intersected in the middle of the lagoon. Figure 13 allows graphically detailing the geography related to the lagoon.

On the south coast of the lagoon, there is a neighborhood named “La Cuesta del Sur”. In this neighborhood, there are one hundred seventy houses and originally, they were used such as weekend houses. Nowadays, there are one hundred families living in the neighborhood, which incorporate a constant traffic by the internal streets and the connection with the routes.

In March of 2017, the volume of fallen water by the rains was excessive for the region related to the Santa Rosa city. Just in three weeks, the volume of water was equivalent to one full year [29]. It provoked that the city keeps partially under the water, generating different kinds of health risks without to enumerate the economic damages. For this reason and in front of this kind of emergency, the water from the city was immediately derived through the waterways to the “Bajo Giuliani” lagoon.

Thus, the volume of derived water through the waterways was constant, and it provoked the incrementing of the level of water related to the lagoon. The concerns started when the water advanced on the land located on the south coast, of the neighborhood, flooding it.

This situation gave origin to this project and the associated application. The indicated points on the south coast of the lagoon in Fig. 13, indicate the initial points established for the installation of the monitoring stations.

Before introducing the monitoring stations, it is important to remark the initial definition of the measurement and evaluation project associated with the lagoon and introduced in Sect. 3. The project’s information need could be defined as “*Monitor*



Fig. 13 The “Bajo Giuliani” lagoon. A descriptive map for the region. The satellite image was obtained through Maps 2.0 (Apple Inc.) with data from TomTom and others

the level of water of the ‘Bajo Giuliani’ lagoon for avoiding flood on the south shore related to the neighborhood’. The entity category is defined such as “*lagoon located in the province of La Pampa*”. The entity under analysis or monitoring is limited to the “*Bajo Giuliani’ lagoon*”. The attributes chosen for characterizing the lagoon are (i) The water temperature, (ii) The ground moisture, and (iii) The water level. The context of the lagoon is described by the following context properties: the environmental temperature and humidity. In this particular case, the incorporation of a camera as a complementary datum is an added-value for describing the region in case of necessity (see Sect. 4.1, Fig. 5).

The Processing Architecture based on Measurement Metadata is located in terms of physical processing in the region indicated as “Base Station” in Fig. 13. The firsts monitoring stations were installed from the south-west coast to the south-east region of the lagoon because the neighborhood is located in a hill, being the south-west coast the lower region. The slope of the hill goes growing-up from the south-west to the south-east coast, being the riskiest region the south-west coast of the lagoon.

The monitoring station is completely based on open hardware, with the aim of an agile reproduction of this kind of experiences. The monitoring station uses the Arduino One (see Fig. 14, the component with ID 1) in the role of the measurement adapter (see Sects. 5 and 6.2) who is responsible for the measure collecting from each sensor. This monitoring station uses the following sensors (i.e. data sources):

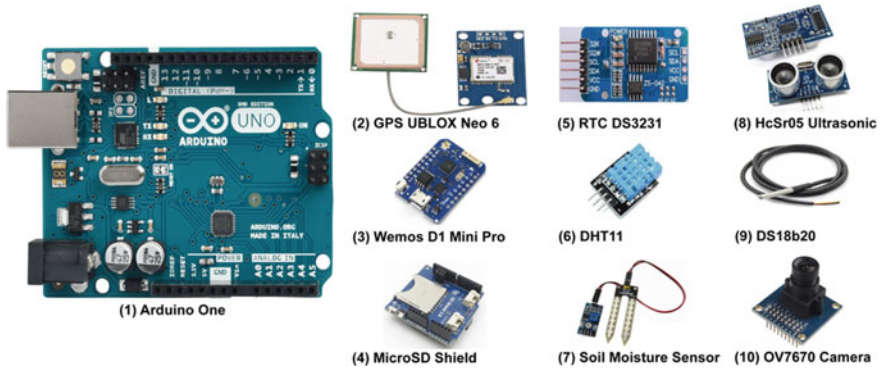

Fig. 14 Set of components based on the Arduino one used for building the monitoring station

(i) DHT11 for the environmental humidity and temperature (see Fig. 14, component with ID 6), (ii) a soil moisture sensor (see Fig. 14, component with ID 7), (iii) an ultrasonic distance sensor for monitoring the level of water from a level of reference (see Fig. 14, component with ID 8), (iv) and the DS18B20 sensor used for measuring the water temperature (see Fig. 14, component with ID 9).

Complementarily, the monitoring station incorporates the complementary data through the GPS UBLOX Neo 6 (see Fig. 14, the component with ID 2) for obtaining the georeferentiation associated with the measures, and the OV7670 camera for taking pictures when it is necessary (see Fig. 14, the component with ID 10). This is an interesting aspect, because the measurement interchange is not only about the estimated or deterministic values related to the metrics, but also the pictures and/or geographic information which allows showing the capacity to interact with embedded multimedia data.

Finally, a real-time clock is incorporated for timestamping the DateTime in each measurement (see Fig. 14, the component with ID 5), jointly with a microSD shield useful for implementing the local buffer in the measurement adapter (see Fig. 14, the component with ID 4).

Thus, this kind of monitoring stations is accessible to everyone who needs to reproduce this kind of experience, even in other sector or industry, such as the agricultural for soil monitoring.

The application allows a real-time monitoring of the level of water related to the lagoon, evaluating at the same time the effect of the summer or spring season and its incidence in the water evaporation. The neighbors and the local governments could access to the real-time measures for knowing the current state of the lagoon, they could receive the flood alarms before the situation happens, and the local governments could regulate the volume of derived water through the waterways when this is possible.

8 Related Works

The idea related to collect data from different kind of data sources is not new, just that now the technology and the computing power made possible new perspectives, applications and, data processing alternatives. Ferdoush and Li [30] have proposed an overall system architecture based on the Raspberry Pi⁹ and Arduino¹⁰ Technology. The work presented a wireless sensor network with the aim of environmental monitoring, which is based on open source hardware platforms for keeping the cost low and facilitating the maintaining of the devices. Vujović and Maksimović [31] developed an architecture for home automation using the RaspberryPi as a sensor web node. A comparison among with the similar hardware platforms in relation to the application case was presented. Both proposals define the data gathering and its associated processing based on open source hardware, leaving the measurement definition as an open aspect, which could have some inconvenient in terms of the result comparisons or when the measurement process should be extended (i.e. the descendent compatibility). In this sense, PAbMM formalizes each operational process, describing through the measurement and evaluation framework, each involved concept with an entity under analysis.

Stephen et al. [32] described STYX, a stream processing with trustworthy cloud-based execution. This proposal makes focus on the confidentiality specifically related to the interchanged data between each device and the data processor in a wireless sensor network. A proposal in an analogous line is introduced by Ghayyur and others by mean of the IoT Detective game [33]. This aspect takes a particular importance when a solution wishes to be generalized satisfying the different kinds of regulations related to the data interchange along the world. For this reason, the measurement interchange schema (see Sect. 4) embeds metadata based on the project definition, which allows knowing the data origin, it keeps the data traceability, it knows the measurement adapter (the intermediary between the data source and the data processor), it incorporates the integrity control inside each cincamimis message with the possibility of protecting its confidentiality.

Andrade et al. [34] present a study in which analyze the behavior of heterogeneous devices (e.g. IoT devices) in a car (i.e. connected cars) based on radio connectivity. The underlying idea is to measure the consuming pattern (e.g. mobility) of the resources on a GSM production network with around one million of the radio connections from the cars. It is an interesting analysis for taking dimension of the data traffic in a tangible domain related to IoT on road. In this sense, PAbMM incorporates the mechanism for online monitoring each data stream in terms of the active projects jointly with the available resources, which takes a particular interest when the decision must be made in real-time (see Sect. 5).

Carvalho et al. [35] introduce the processing of distributed data streams based on an architecture oriented to IoT smart grids monitoring. The architecture relationships the IoT with the heterogeneous data sources contained in the sensor networks,

⁹<https://www.raspberrypi.org>.

¹⁰<https://www.arduino.cc>.

making a focus on the smart grid data profiles. In this approach, Apache Kafka¹¹ is used on the message layer, while the processing layer is based on Spark Streaming.¹² It is a similar view in relation to PAbMM, but the main difference is associated with the way in which the monitoring project is defined, and the data interchange. That is to say, PAbMM uses a measurement and evaluation framework as the underlying supporting for the project definition, giving existence to the CINCAMI/Project Definition. Even, the measurement interchange schema (i.e. CINCAMI/MIS) is the way in which heterogeneous data sources and the data processor carry forward a common understanding in relation to the data meanings, the associated project, and its entity under monitoring (e.g. 38.3 is a temperature coming from a sensor monitoring the child's corporal temperature in Fig. 2).

The data collecting jointly with the data processing for supporting real-time decisions currently has different kinds of applications, some of them are: (i) the role of the fog computing, IoT and cloud computing in the healthcare 4.0 for providing uninterrupted context-aware services [36]; (ii) The role of the IoT and smart grids in the context of the smart cities [37]; (iii) Aspects related to the security alert systems for smart home [38]; (iv) The vehicle air pollution monitoring based on IoT devices [39]; (v) The role of the ontology for the platform scalability in the complex IoT contexts [40], among others. In addition, the multimedia big data implies the proliferation of the multimedia data in the big data repositories (e.g. audio, video, etc.), and this aspect was introduced with the complementary data in the measurement interchange schema (see Sect. 4). In this sense, taxonomies and a model process are described in [38], addressing different kinds of challenges in the area, such as the reliability, heterogeneity, etc. In this line, PAbMM has an underlying ontology based on the measurement and evaluation framework named C-INCAMI, which is used for the project definition (i.e. CINCAMI/PD) and the measurement interchange schema (i.e. CINCAMI/MIS). Thus, each actor in the architecture knows the responsible sensor for an attribute, the associated meaning, the way in which the data should be processed, and the normal behavior patterns defined by the experts in the project definition (coming from the organizational memory).

9 Conclusions and Future Works

Nowadays the different kinds of the data sources and its evolution, carry us to a heterogeneous environment in which each time the components trend to keep a continuous interaction as a form to self-organizing for satisfying a given objective. In this environment, the heterogeneity is the norm which rules the different applications, be it through the sensors or even the kind of the data that need to be processed (i.e. from the raw data to the information geographic in its different forms). Moreover, the data sources (i.e. sensors) are permanently generating data for its processing

¹¹<https://kafka.apache.org>.

¹²<https://spark.apache.org/streaming/>.

and consuming. Thus, and when the data should be stored (synthesized or not) the volume and the associated rate of the data is increased in a significant way falling in the Big Data environment. Nowell, the online data processing is a very different context than the Big Data environment, because when in the first the real-time data processing is a priority, in the second the batch data processing is the rule. This is important to highlight because the data processing strategies are very different like the needed resources for carrying forward the processing in its different forms. In this sense, the chapter introduced an integrated perspective for the data processing in the heterogeneous contexts, incorporating the process description through BPMN.

The measurement process is a key asset when the monitoring must be carried forward on a given target. In this sense, the determination about the concept or object to be monitored jointly with the way in which the measurement is carried forward constitutes the base for the data-driven decision making. That is to say, the decision maker must support each decision based on the information and not the mere intuition.

Thus, before any kind of the data processing for the data coming from the sensors, it is necessary to warranty the processability and the understandability related to the data to be processed in terms of the measurement process. For that reason, this chapter introduced the idea of the measurement and evaluation framework (e.g. C-INCAMI), like the way in which the measurement process could warranty the comparability of its results, the repeatability, and extensibility of the process itself. For example, the C-INCAMI framework allows using the terms, concepts and its relationships for defining the information need of the project, the entity to be monitored, the descriptive attributes for the entity, the descriptive context properties for the environment in which the entity is located, the associated metrics, among other essential aspects for knowing the way in which each aspect related to an entity under monitoring is quantified.

In this way, the CINCAMI/Project Definition (PD) schema was presented as the way in which the M&E project definitions based on the C-INCAMI framework could be interchanged among different systems, independently of the creator software. It is interesting because fosters the interoperability in terms of the project definitions, avoiding the dependence of a particular or proprietary framework. The C-INCAMI/PD library which allows the supporting, interchanging and interpretation of each project definition under this schema are, it is open source and freely available on the GitHub repository.

In a heterogeneous environment and when it is possible to agree on the way in which an entity will be monitored, then it is possible to understand the role of each metric (or variable) in relation to the entity under monitoring jointly with its expected incidence. Thus, starting from a definition based on the CINCAMI/PD schema, the chapter introduced the role of the measurement adapter in terms of its relationship with the sensors who show a passive behavior. The measurement adapter allows carrying forward the data collecting, but also the translating of the heterogeneous data from its proprietary data format to the measurement interchange schema (i.e. CINCAMI/MIS). The measurement interchange schema allows homogenizing the data interchanging based on the project definition and the underlying concepts and terms

coming from the measurement and evaluation framework. This is a key asset because the data collecting and processing are guided by the metadata and the metadata are directly associated with the way in which an attribute or context property should be quantified and interpreted. The measurement interchange schema has an associated library freely available on the GitHub repository useful for fostering the use and interchange of the measures based on the project definition. For this reason, Both the measurement adapter and the processing architecture are able to carry forward the data collecting and processing respectively because they share a common definition and communication language. That is to say, in case of the use of the deterministic measures or the incorporation of complementary data (e.g. a picture, a video, etc.), the measurement adapter knows the way in which the association sensor-metric should be made following the project definition, and in addition, it knows the way in which the same information should be informed through a CINCAMI/MIS stream. In an analogous way, the processing architecture knows the way in which each CINCAMI/MIS should be read, and by the use of the project definition, the architecture knows the role of each attribute or context property in relation to the project's aim jointly with the role of the eventually informed complementary data.

The processing architecture incorporates the real-time data processing on the measurement streams, incorporating a detective behavior through the statistical analysis and the analysis of the project definition, jointly with a predictive behavior based in the use of the incremental classifiers. The architecture contemplates the possibility of replication of the measurement streams jointly with the storing of the data, be it in a direct way or by mean of a synthesis algorithm. In any case, the role of the processing architecture when some typified situation or alarm happen, is looking for recommendations for attaching to the notification to send. For this reason, an organizational memory is used as a guide for capitalizing the previous experience and the knowledge from the experts, but also for storing the project definitions, the historical data and the training data set for the initial training of the classifiers.

A real application of the processing architecture was synthesized for the lagoon monitoring and its incidence in the "La Cuesta del Sur" neighborhood (Santa Rosa, La Pampa, Argentina). This kind of applications and the positive social impact for the governments, people and the private organizations allows projecting many kinds of the business plan and social applications, from the farm monitoring, flood monitoring, fire monitoring, among a lot of applications, in which the real-time monitoring could positively increment the benefits and the profits with a minimal cost. That is to say, the investment related to each monitoring station is minimum (e.g. around 50 dollars depending the precision, accuracy, and kind of sensors to be used), and the involved software is open source reason which there is no additional cost.

The semantic similarity related to two or more entity under analysis is an active researching line. That is to say, the entities are characterized by the attributes in terms of the C-INCAMI framework. Each metric is directly associated with an attribute (or context property). The current structural coefficient is used for the in-memory filtering of the organizational memory looking for the entities that share as many attributes as possible. Thus, in case of absence of recommendations for an entity, it is possible to reuse the previous knowledge from other similar entity. However,

the structural coefficient is based on the attribute comparison by the name, but not based on its definition (i.e. the meaning). Thus, the active line refers to obtain a semantic coefficient able to be applied to the Spanish language, for knowing when two attributes for the same entity correspond to the same concept based on a narrative definition (i.e. the explanation of the meaning of each attribute given in the project definition), independently the given name to each attribute.

References

1. J. Zapater, From Web 1.0 to Web 4.0: the evolution of the web, in *7th Euro American Conference on Telematics and Information Systems* (ACM, New York, 2014), pp. 2:1–2:1
2. G. Nedeltcheva, E. Shoikova, Models for innovative IoT ecosystems, in *International Conference on Big Data and Internet of Thing* (ACM, New York, 2017), pp. 164–168
3. N. Chaudhry, Introduction to stream data management, in *Stream Data Management. Advances in Database Systems*, vol. 30, ed. by N. Chaudhry, K. Shaw, M. Abdelguerfi (Springer-Verlag, New York, 2005), pp. 1–13
4. S. Chakravarthy, Q. Jiang, *Stream Data Processing: A Quality of Service Perspective, Advances in Database Systems*, vol. 36 (Springer Science + Business Media, New York, 2009)
5. D. Laney, *Infonomics. How to Monetize, Manage, and Measure Information as an Asset for Competitive Advantage* (Routledge, New York, 2018)
6. N. Khan, M. Alsaqer, H. Shah, G. Badsha, A. Abbasi, S. Salehian, The 10 Vs, issues and challenges of big data, in *International Conference on Big Data and Education* (ACM, New York, 2018), pp. 52–56
7. A. Davoudian, L. Chen, M. Liu, A survey on NoSQL stores. *ACM Comput. Surv. (CSUR)* **51**, 40:1–40:43 (2018)
8. T. Ivanov, R. Singhal, Abench: big data architecture stack benchmark, in *ACM/SPEC International Conference on Performance Engineering* (ACM, New York, 2018), pp. 13–16
9. F. Gessert, W. Wingerath, S. Friedrich, N. Ritter, NoSQL database systems: a survey and decision guidance. *Comput. Sci. Res. Dev.* **32**, 353–365 (2017)
10. M. Garofalakis, J. Gehrke, R. Rastogi, Data stream management: a brave new world, in *Data Stream Management. Processing High-Speed Data Streams, Data-Centric Systems and Applications*, edited by M. Garofalakis, J. Gehrke, R. Rastogi (Springer-Verlag, Heidelberg, 2016), pp. 1–9
11. T. De Matteis, G. Mencagli, Proactive elasticity and energy awareness in data stream processing. *J. Syst. Softw.* **127**, 302–319 (2017)
12. I. Flouris, N. Gitrakos, A. Deligiannakis, M. Garofalakisa, M. Kamp, M. Mock, Issues in complex event processing: status and prospects in the Big Data era. *J. Syst. Softw.* **127**, 217–236 (2017)
13. N. Hidalgo, D. Wladdimiro, E. Rosas, Self-adaptive processing graph with operator fission for elastic stream processing. *J. Syst. Softw.* **127**, 205–216 (2017)
14. P. Tsiachri Renta, S. Sotiriadis, E. Petrakis, Healthcare sensor data management on the cloud, in *Workshop on Adaptive Resource Management and Scheduling for Cloud Computing* (ACM, New York, 2017), pp. 25–30
15. T. Bennett, N. Gans, R. Jafari, Data-driven synchronization for internet-of-things systems. *ACM Trans. Embed. Comput. Syst. (TECS)* **16**, 69:1–69:24 (2017). Special Issue on Embedded Computing for IoT, Special Issue on Big Data and Regular Papers
16. A. Meidan, J. Garcia-Garcia, I. Ramos, M. Escalona, Measuring software process: a systematic mapping study. *ACM Comput. Surv. (CSUR)* **51**, 58:1–58:32 (2018)
17. Y. Zhou, O. Alipourfard, M. Yu, T. Yang, Accelerating network measurement in software. *ACM SIGCOMM Comput. Commun. Rev.* **48**, 2–12 (2018)

18. V. Mandic, V. Basili, L. Harjumaa, M. Oivo, J. Markkula, Utilizing GQM + strategies for business value analysis: an approach for evaluating business goals, in *ACM-IEEE International Symposium on Empirical Software Engineering and Measurement (ACM, New York, 2010)*, pp. 20:1–20:10
19. L. Olsina, F. Papa, H. Molina, How to measure and evaluate web applications in a consistent way, in *Web Engineering: Modelling and Implementing Web Applications*, ed. by G. Rossi, O. Pastor, D. Schwabe, L. Olsina (Springer-Verlag, London, 2008), pp. 385–420
20. H. Molina, L. Olsina, Towards the support of contextual information to a measurement and evaluation framework, in *Quality of Information and Communications Technology (QUATIC)* (IEEE Press, New York, 2007), pp. 154–166
21. M. Diván, M. Martín, Towards a consistent measurement stream processing from heterogeneous data sources. *Int. J. Electric. Comput. Eng. (IJECE)* **7**, 3164–3175 (2017)
22. P. Becker, Process view of the quality measurement and evaluation integrated strategies. Ph.D. Thesis, National University of La Plata, La Plata, Argentina (2014)
23. M. Diván, M. Sánchez Reynoso, Fostering the interoperability of the measurement and evaluation project definitions in PAbMM, in *7th International Conference on Reliability, Infocom Technologies and Optimization (ICRITO)* (IEEE Press, New York, 2018), pp. 228–234
24. M. Diván, Data-driven decision making., in *1st International Conference on Infocom Technologies and Unmanned Systems (ICTUS)* (IEEE Press, New York, 2017), pp. 50–56
25. L. Dalton, Optimal ROC-based classification and performance analysis under bayesian uncertainty models. *IEEE/ACM Trans. Comput. Biol. Bioinformatics* **13**, 719–729 (2016)
26. N. Razali, Y. Wah, Power comparisons of Shapiro-Wilk, Kolmogorov-Smirnov, Lilliefors and Anderson-Darling tests. *J. Stat. Model. Anal.* **2**, 21–33 (2011)
27. G. Morales, A. Bifet, SAMOA: scalable advanced massive online analysis. *J. Mach. Learn. Res.* **16**, 149–153 (2015)
28. M. Diván, M. Sánchez Reynoso, Behavioural similarity analysis for supporting the recommendation in PAbMM. in *1st International Conference on Infocom Technologies and Unmanned Systems (ICTUS)* (IEEE Press, New York, 2017), pp. 133–139
29. B. Dillon, A view of the flood from a flight of the UNLPam's Geography Institute (original title in Spanish: La Inundación vista desde un vuelo del Instituto de Geografía de la UNLPam). *La Arena Daily*. http://www.laarena.com.ar/la_ciudad-no-podemos-hacer-cargo-a-la-fatalidad-ola-naturaleza-1128851-115.html
30. S. Ferdoush, X. Li, System design using Raspberry Pi and Arduino for environmental monitoring applications. *Proc. Comput. Sci.* **34**, 103–110 (2014)
31. V. Vujović, M. Maksimović, k Raspberry Pi as a Sensor Web node for home automation. *Comput. Electric. Eng.* **44**, 153–171 (2015)
32. J. Stephen, S. Savvides, V. Sundaram, M. Ardekani, P. Eugster, STYX: stream processing with trustworthy cloud-based execution, in *Seventh ACM Symposium on Cloud Computing (ACM, California, 2016)*, pp. 348–360
33. S. Ghayyur, Y. Chen, R. Yus, A. Machanavajjhala, M. Hay, G. Miklau, S. Mehrotra, IoT-detective: analyzing IoT data under differential privacy, in *ACM International Conference on Management of Data (ACM, Texas, 2018)*, pp. 1725–1728
34. C. Andrade, S. Byers, V. Gopalakrishnan, E. Halepovic, D. Poole, L. Tran, C. Volinsky, Connected cars in cellular network: a measurement study, in *Internet Measurement Conference (ACM, London, 2017)*, pp. 1725–1728
35. O. Carvalho, E. Roloff, P. Navaux, A distributed stream processing based architecture for IoT smart grids monitoring, in *10th International Conference on Utility and Cloud Computing (ACM, Texas, 2017)*, pp. 9–14
36. A. Kumari, S. Tanwar, S. Tyagi, N. Kumar, Fog computing for healthcare 4.0 environment: opportunities and challenges. *Comput. Electr. Eng.* **72**, 1–13 (2018)
37. S. Tanwar, S. Tyagi, S. Kumar, The Role of internet of things and smart grid for the development of a smart city, in *Intelligent Communication and Computational Technologies, LNNS*, vol. 19, ed. by Y. Hu, S. Tiwari, K. Mishra, M. Trivedi (Springer, Singapore, 2018), pp. 23–33

38. S. Tanwar, P. Patel, K. Patel, S. Tyagi, N. Kumar, M. Obaidat, An advanced internet of thing based security alert system for smart home, in *IEEE International Conference on Computer, Information and Telecommunication Systems (CITS)* (IEEE Press, Dalian 2017), pp. 25–29
39. S. Pal, A. Ghosh, V. Sethi, Vehicle air pollution monitoring using IoTs, in *16th ACM Conference on Embedded Networked Sensor Systems* (ACM, Shenzhen 2018), pp. 400–401
40. J. Teh, V. Choudhary, H. Lim, A smart ontology-driven IoT platform, in *16th ACM Conference on Embedded Networked Sensor Systems* (ACM, Shenzhen 2018), pp. 424–425
41. A. Kumari, S. Tanwar, S. Tyagi, N. Kumar, M. Maasberg, K. Choo, Multimedia big data computing and Internet of Things applications: a taxonomy and process model. *J. Netw. Comput. Appl.* **124**, 169–195 (2018)

Deep Learning for Multimedia Data in IoT



Srinidhi Hiriyannaiah, B. S. Akanksh, A. S. Koushik, G. M. Siddesh and K. G. Srinivasa

Abstract With the advent of Internet leading to proliferation of large amounts of multimedia data, the analytics of the aggregated multimedia data is proven to be one of the active areas of research and study. Multimedia data includes audio, video, images associated with applications like similarity searches, entity resolution, and classification. Visual data mining is now one of the active learning fields that include surveillance applications for object detection, fraud detection, crime detection, and other applications. Multimedia data mining includes many challenges like data volume, variety, and unstructured nature, nonstationary, and real time. It needs advanced processing capabilities to make decisions in near real time. The existing traditional database systems, data mining techniques cannot be used because of its limitations. Hence, to process such large amounts of data advanced techniques like machine learning, deep learning methods can be used. Multimedia data also includes sensor data that is widely generated. Most of the healthcare applications include sensors for detecting heart rate, blood pressure, and pulse rate. The advancement of the smartphones has resulted in fitness based applications based on the number of steps walked, calories count, kilometers ran, etc. All these types of data can be classified as Multimedia data for Internet of Things (IoT). There are many interfacing devices that are interconnected to each other with backbone as a computer network when sensor data is involved. The main aim of this chapter is to highlight the importance and convergence of deep learning techniques with IoT. Emphasis is laid on classification

S. Hiriyannaiah (✉) · B. S. Akanksh · A. S. Koushik · G. M. Siddesh
Ramaiah Institute of Technology, Bengaluru, India
e-mail: srinidhi.hiriyannaiah@gmail.com

B. S. Akanksh
e-mail: bsakanksh@gmail.com

A. S. Koushik
e-mail: askoushik4@gmail.com

G. M. Siddesh
e-mail: siddeshgm@gmail.com

K. G. Srinivasa
National Institute of Technical Teacher Training Research, New Delhi, India
e-mail: kgsrinivasa@gmail.com

© Springer Nature Singapore Pte Ltd. 2020
S. Tanwar et al. (eds.), *Multimedia Big Data Computing for IoT Applications*, Intelligent Systems Reference Library 163,
https://doi.org/10.1007/978-981-13-8759-3_4

of IoT data using deep learning and the essential fine-tuning of parameters. A virtual sensor device implemented in python is used for simulation. An account of protocols used for communication of IoT devices is briefly discussed. A case study is provided regarding classification of Air Quality Dataset using deep learning techniques.

Keywords Multimedia data · IoT · Air quality analysis · Deep learning · IoT analytics

1 Introduction to Multimedia and IoT

Data Mining has gained a greater significance in recent days due to the large amount of data being collected and its availability over the Internet. The significant advances in the big data technology and tools have lead to the development of analytics and research in this area over the years. There is a paradigm shift of data mining to big data analytics that involves various stages of processing and analysis. Big data analytics consists of exploration of data, identifying the relationships among the different features in the data and visualize it. The applications of big data analytics include various multidisciplinary fields such as machine learning, information retrieval, databases, and visualization. These significant advances have lead to the evolution of multimedia management systems.

Multimedia data includes image, video, audio, and text. Due to the advent of smartphones and Internet, this kind of multimedia data has to lead to several applications and sharing platforms [1]. The valuable sources of multimedia data are social media such as Instagram, YouTube, Twitter, and Facebook [2]. The volume of data being collected at these sites is significantly increasing day by day. For example, in Instagram users have uploaded over 20 billion photos, 100 videos are uploaded every minute per day on YouTube, 500 million tweets on twitter. Such huge amount of information plays an important source for analyzing different patterns and developing applications. This rich source of information is termed as “Big data”. Big data posses three essential features namely variety, velocity, and volume. The proliferation of big data in terms of volume, velocity, and variety has reached to different domains as shown in Fig. 1. In this chapter, the focus is on IoT applications and multimedia.

Internet of Things (IoT) is a network of things that are connected to each other which is supported by Internet for communication. Most of the devices nowadays are sensor based and is connected to one or more usually. It is estimated in most of the reviews that the total devices that will be connected to each other will 20 billion by 2020 [3]. With the increase in the number of devices that are connected to each other, the generation of multimedia data also increases. The scope of IoT is not limited to the sensor data alone but also relates to multimedia. For example, CCTV camera captures the video data for surveillance purposes which can be categorized as multimedia data. The fingerprint data can also be regarded as the multimedia data since it is in the form image. The applications of such data are utilized in smart

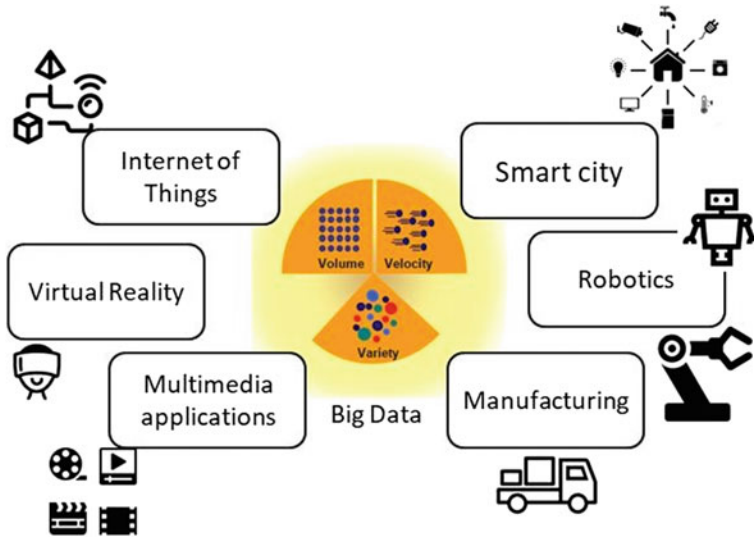

Fig. 1 Big data and applications

communities such as smart city, smart power, smart grid, etc. [3]. Hence, multimedia analytics play a crucial role in the field of IoT as well.

Multimedia analytics can be carried out using conventional analytical approaches such as clustering, decision tree methods. However, a major challenge faced with the conventional approaches is the scalability of the methods and the execution time required to produce the results [4]. In this regard, Deep learning and GPU computing methods are used for multimedia analytics. Deep learning methods that involve deep forward networks, recurrent networks are used most of the times for multimedia analytics. The features that are present in the multimedia data need to be extracted so that clear decision can be made. The main challenge of deep learning is feature extraction process involves stages of object recognition, object detection from the edges identified in the image.

Multimedia applications need a different kind of approach for analysis compared to conventional analytical techniques [4]. The conventional techniques of data analysis such as clustering, regression, naïve bayes classification can be used on the stationary data. Since multimedia data and IoT data is nonstationary, techniques that are based on streaming analysis are useful. The different types of enabling technologies for multimedia analysis and IoT data classification are discussed in the further sections.

The focus of this chapter is to introduce the advances in multimedia data, challenges in multimedia analytics and how deep learning methods can be used for multimedia analytics. An illustration regarding communication of IoT devices is provided. A brief account regarding MQTT protocol and its fundamental operations such as publish and subscribe is discussed. In the final section of the chapter, a case

study on IoT data classification is presented. The chosen dataset for this purpose is Air Quality dataset. It deals with creating a deep learning model to classify IoT data along with the associated code.

2 Advances in Multimedia Data

In the data analytics world, data has been proliferated in different ways. Multimedia data is one of such data that has been recently generated in huge volumes in the Internet. It is being captured by various multimedia computing devices like computers, tablets, mobile phones, and cameras [5]. The nature of the data being captured is also ubiquitous. Initially, started with audio, video it has now reached animations in the form of gifs. The advances in multimedia data are summarized as follows.

- **Visual data:** The most common form of multimedia data found is the video data. A visual data consists of a sequence of image sequences that has to analyze one-by-one. Most of the unstructured information exists in the form of visual data and contains very rich information. Visual data analytics process involves extracting meaningful information from the different image sequences that are present in the visual data. However, the main challenge lies in the size of the visual data. Recent technologies such as cloud computing, high-performance computing have enabled the visual data and analytics research in areas such as video surveillance systems, autonomous systems, and healthcare. The advances in visual data and analytics are challenging the human brain and its computation. In [5] one of the competitions held, machine outperformed the humans in image classification.
- **Audio data:** One more type of multimedia data that is mostly used is audio/speech data. Real-time audio analytical applications are needed in social media, healthcare, and industry. Audio analytics involves extracting useful information from the different pieces of the information present in the audio data. Call centers are one of industry applications that need audio analytics for interaction with the customer and training the persons involved in the call center. Big data platforms such as Spark, Hadoop, and different libraries are widely used for such audio analytical applications.
- **Text data:** Multimedia data may be embedded in the textual context in the form of web pages, surveys, feeds, and metadata. The analysis of such data helps to gain interesting insights. Multimedia data in the form of text can be structured or unstructured. The structured kind of data can be analyzed with the help of traditional relational database techniques of query retrieval. However, the multimedia data in the form of feeds are unstructured and needs to be transformed into a structured format for further analysis [6]. One of the example applications of multimedia text analytics is based on a particular situation like election, natural disaster, stock market, etc. The emotions behind the text can be analyzed with the help of multimedia data analysis. In this way, different kinds of information can be extracted from different sources of multimedia textual data.

- **Sensor data:** IoT is playing a significant role nowadays and sensors are present almost everywhere. The sensors are equipped with not only capturing the data but also apply analytics in real time [7]. With the advances in the hardware and the technologies of cloud computing, sensor data are increasing enormously. It is highly challenging to analyze such data and develop an analytical application based on that. Sensor data applications are highly seen in astronomical sciences for meteorological patterns, satellite conditioning, and monitoring. In healthcare, most of the applications are based on sensor data. Therefore, with the advances in the sensor data, it is highly essential to develop analytical applications based on it.
- **Social networks:** The main source for multimedia data is social networks. The advances in social networking and sharing that started from a normal text have now reached to image, video, live video, public groups, etc. Recommendation applications [7] widely use the multimedia content available in the social networks to provide recommendations by analyzing the shared messages, video, audio, and text. Personalization services are more widely used by the users of smartphones based on the subscriptions made by them.

The main characteristic nature of the multimedia data is variety. It exists in different forms and at various sources. These advances in multimedia data and analytics have enabled various challenges and technologies for developing different applications. Though, there are various technologies that exist for multimedia analytics the challenges that are put forth for analysis are more and have to be addressed carefully. In the next section, the different challenges that exist for multimedia analytics are discussed followed by the enabling technologies for multimedia analytics.

3 Challenges in Multimedia Data

Multimedia data involves the data from various sources such as cameras, social network, sensors and other that heterogeneous in nature. In order to carry out analytics for such data, the heterogeneity nature of such data has to be transformed for analysis purposes. The transformation of the data involves converting the data from different formats into a singular format for analytics. Some of the challenges that are generally seen with multimedia analytics are discussed below.

3.1 Data Acquisition and Volume

Multimedia data takes a large amount of storage for analytics and involves the acquisition of data from various sources. There are different heterogeneous sources that are involved such as social media, sensors, mobile devices, cameras, and virtual worlds [4]. The heterogeneous data that are generated from these sources are mul-

tistructural and multimodal in nature. Each of the source exhibit different kind of characteristics and highly complex in acquisition both in terms of quantity and quality. New techniques and technologies are needed to understand the varying nature of the multimedia data for acquisition [4, 6].

With the unprecedented growth of multimedia data, there is a huge challenge of storage and making it available for multimedia applications. There are many investigations done for addressing this challenge in multimedia data. In [7], a big data processing pipeline is introduced along with MapReduce that consists of stages such as data preprocessing, data recognition and load reduction. NoSQL databases play a significant role in the storage of multimedia data that allows flexibility of the schema involved in the storage. The different enabling technologies that can handle this issue are addressed in the next section.

3.2 Feature Extraction

Multimedia data such as audio and video includes numerous features. The process of extracting the features from this data plays a significant role in multimedia analytics. The different features of the video can be color, edge, shape, and texture of the image sequences in the video. The extraction of features is divided into two categories namely local feature extraction and global feature extraction. Global feature extraction techniques involve obtaining the color histogram of different objects that are present in the image sequence of the video. The development of color histograms helps in identifying the edges of the objects to distinguish among them. However, it involves a great amount of time since the data will be huge in volume and need to be compressed. In some of the situations, the color histogram may not be successful. Hence, feature extraction is one of the main challenges faced in Multimedia analytics [3]. The different types of techniques for feature extraction are discussed in the next section.

3.3 Synchronization and Computing

Multimedia analytics deals with both audio and video. The main challenge of multimedia analytics is in the synchronization of audio and video. For example in health-care systems, 3-D based multimedia data need to be taken care of for analytics [8]. A two-tier based synchronization is required for some of the multimedia systems. The research in computing for analytics on multimedia data involves many big data computing platforms like Hadoop, Cassandra, and NoSQL databases. Pipelines of such platforms are required for computation and analysis.

The computational methods for multimedia analytics are mostly based on machine learning techniques like support vector machines (SVM), clustering. However, two or more techniques are usually combined together for multimedia analytics. GPU

computing is utilized in most of the multimedia analytics since the amount of the data is huge in volume. Parallel computing is carried out for multimedia analytics with the GPU to reduce the time of computation and to deal with the nonstationary multimedia data. However, computational methods that are scalable are still a challenge for multimedia analytics.

3.4 Security

Multimedia analytics involves data that are user-centric and contains some of the sensitive information of the users. The analysis performed on such data should have necessary techniques to not utilize the user identity information but carry out analysis [3]. For example, in the sentimental analysis of social network data, the user identity should not be revealed but the textual content can be utilized. Here, the textual content needs to be used rather than the identity of the users. However, geospatial analytics might reveal the geographical information about the users. In such cases, analytical techniques should be careful in revealing the information based on the analysis.

4 Enabling Technologies

Multimedia analytics is analyzing multimedia data such as audio, video, and text to identify the patterns in data and take decisions based on the patterns found. There are various stages of multimedia analytics like data preprocessing, feature extraction and analysis. In each stage, different types of technologies are used for leveraging the analytics and decision-making process. This section focuses on the different enabling technologies and platforms for multimedia analytics. In this regards, multimedia data is categorized into three parts namely text analytics, video analytics, and audio analytics. The enabling technologies in each of the category are summarized as shown in Table 1.

Table 1 Enabling technologies for multimedia analytics

Enabling technology	Language	Open source
NLTK	Python	Yes
Hadoop and Spark	Java, Python, Scala	Yes
Tableau	Java, Python	Partially
Graph databases	Python	Partially
LibROSA	Python	Yes
OpenCV	Python	Yes

4.1 Text Analytics

The most common form of multimedia data is text. It is highly volatile in nature since the text written by humans is unstructured and differs from person to person. There are various stages of text analytics such as removal of stop words like “is”, “was”, “this”. For example, in the case of sentimental analysis, the key phrases of the text are important for analysis rather than the stop words in the text. Some of the enabling technologies that are available for text analytics are discussed below.

- **NLTK**

Natural language Toolkit (NLTK) is one of the famous python based tools used for natural language processing. Most of the text analytics stages such as preprocessing, tokenization, stemming, tagging, parsing, and semantic reasoning can be performed using various modules that are available within NLTK. Corpus information is most needed while performing text analytics. For example, in the scenario of sentimental analysis a corpus of information that identifies the positive and negative sentiments are needed. WordNet a corpus is available in NLTK for text analytics. The main advantage of NLTK is python based that helps in easy understanding and analysis [9].

- **Deep Learning**

The recent hype of Artificial intelligence and robotics has paved the way for different deep learning frameworks. Deep learning platforms such as Pytorch and Tensorflow are widely used for text analytics in multimedia systems. The texts that cannot be captured through the World Wide Web are analyzed using deep learning techniques like CNN and RNN architectures. Some of the examples include detection of actions in video, identifying disasters in the web crawled datasets.

- **Scikit learn**

It is one of the scientific tool kits available in Python platform. Most of the machine learning techniques are provided in the form of APIs that helps in ease of programming. In text analytics, a bag of words is required to identify the most significant words that are present in the text dataset considered. Scikit learn provides such functions like “bag-of-words”, “tf-idf” which are needed for text analytics. The term document frequency (TF) is mainly needed to identify the most occurred terms in the text. In this way, Scikit learn is one of the enabling technologies for text analytics [10].

- **Hadoop and Spark**

Hadoop is one of the open source platforms that can be used to analyze any format of data. MapReduce programming is used to extract the data in the form of text present in Hadoop file system for analysis. It helps in aggregating the information that is present in the form of text. For example, a file containing the users and the channels subscribed by them can be analyzed with the help of MapReduce to find the top subscribed channels [11]. Spark is one of the open-source platforms that

provides numerous machine learning libraries in the form of Spark MLlib [12] for performing different types of analytics.

4.2 Video Analytics

Major chunk of the multimedia data is in the form of video. Visual data analytics is a convoluted process since it involves a number of image sequences [13]. Other than the image sequences, visual data can be in the form of graphs and networks of text. There are some enabling technologies that help in visual analytics that are summarized below.

- **Convolution neural networks (CNN) using deep learning**

CNN is the widely used technique for video analytics. The applications of CNN to video analytics include object detection, crime detection, etc. In CNN, the image sequence is first divided into various pixels and then brought down to scale for object detection. The image is first divided into various filters that represents a matrix of values of the image [14]. The filters are convolved into a matrix of less value by product and sum of two matrices. For example, a 2D image convolution is as shown below.

2-D Image					Convolved Feature		
1 × 0	1 × 1	1 × 0	0 × 1	0 × 0	2	3	2
0 × 1	1 × 0	1 × 1	1 × 0	0 × 0	2	3	3
0 × 1	0 × 1	1 × 0	1 × 1	1 × 0	2	3	3
0 × 0	0 × 1	1 × 1	1 × 0	0 × 1			
0 × 1	1 × 0	1 × 1	0 × 0	0 × 1			

Once the convolved feature matrix is obtained, a series of convolution layers are built to obtain the final feature matrix and carry out the object detection.

In this way, CNN architectures are used in video analytics.

- **Tableau**

Multimedia data involves social network data that can be in the form of feeds or tweets. Visualization of such data helps in revealing the interesting patterns about the data. Tableau is one of such tools that help in understanding the data by visualizing first the data and then to carry out analysis. Tableau is the leading Data Visualization and Business Intelligence tool that helps in creating interactive visualizations. The visualization tool provides an easy to use interface to create dashboards and help solve complex business problems in a fast and effective way. Tableau also can connect to a vast set of files, databases, data warehouse, etc., to carry out analysis on the data from multiple sources.

- **OpenCV**

OpenCV is one of the platforms widely used for video analytics. It stands for Open source computer vision library. It provides the necessary libraries for real-time object detection within a video. The applications of OpenCV includes facial recognition system, gesture recognition, motion tracking, augmented reality, mobile robotics [15]. It includes most of the machine learning algorithms like k-means clustering, Bayesian classification, decision tree learning, random forest classifier, and artificial neural networks.

4.3 Audio Analytics

Multimedia data that is in the form of audio needs extensive computing and time for arriving at results. The data present in the audio format need to be analyzed stage by stage since it differs from time to time. Some of the enabling technologies for audio analytics are summarized as below.

- **LibROSA**

It is one of the libraries that is available in python for analysis of various audio files [16]. It helps in the development of various audio applications based on different formats. It helps in extracting the features of the music files like rhythm, tempo, beats, audio time series, power spectrogram of the audio, roll of frequency, spectral flatness, etc.

- **Deep learning**

Deep learning is used for audio analysis using the artificial neural networks like Recurrent Neural Nets (RNN), Convolutional Neural Networks (CNN), and feed-forward networks. Recent developments in the computer science has paved the way for different applications in audio processing using deep learning. One of such experiments has been done in [14] to develop a framework for audio event recognition based on the web data. A CNN is developed as a part of the experiment with five hidden layers. Some of the learning methods are explored in the further sections.

5 Deep Learning Methods

In any dataset features/attributes play an important role to develop learning algorithms. In deep learning methods, these features play an important role in developing appropriate learning algorithms. A feature can be defined as the interesting part of the dataset that acts as the starting point for learning. The desirable property of any learning algorithm is the repetitive process of detecting the features for the dataset that is not trained. The important features for an image dataset are temporal, spatial, and textural. There are three stages in any feature detection algorithm namely

extraction, selection, and classification. The output of the extraction phase is a representation vector of the dataset/image considered. The representation vectors can be different for different datasets. It is used for classification purposes using deep learning methods like CNN, RNN, and feed-forward networks [17, 18].

5.1 Local Feature Extraction Methods

A feature is a function that represents the quantified value of an object/dataset. It represents the significant features of the object such as color, texture, and pixels. Local features of a dataset/image refer to the characteristics of the image that adheres to edge detection, image segmentation, and the features that are calculated on the results of the subdivision of the image. The most common methods that are used for local feature extraction using deep learning are as follows.

- **Haris Corner detection**

Corner detection is used in the computer vision systems to infer some of the interesting facts of the image and its corners. It is usually used for applications like motion detection, video tracking, 3D modeling, and object recognition. One of the methods that are used is Haris corner detection that is based on the intensity of the corners [19]. The basic idea is to observe a large change in appearance when there is a shift in the window in any direction. The normal three scenarios of corner detection are as shown in Fig. 2. The change in the shift of the intensity says $[u, v]$ is calculated as shown in the Eq. 1.

- **Scale Invariant Feature Transformation (SIFT)**

It is used to detect local features in the image for applications such as gesture recognition, video tracking, 3D modeling, etc. A set of key features in the image are extracted and stored in a database. For a new image, the features are compared

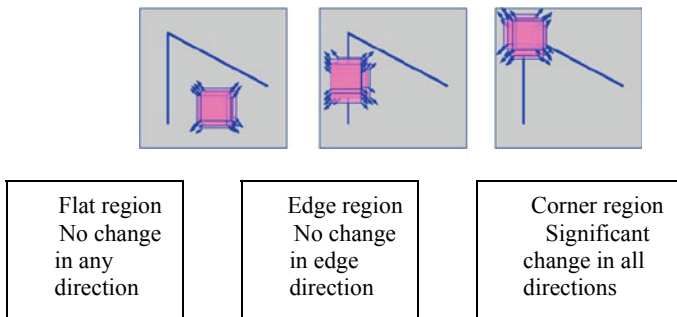

Fig. 2 Haris corner detection

against the existing database to determine the best candidate matching using the Euclidean distance of the feature vectors [20]. In order to filter out the matching from the database, a subset of the keypoints that are matched with location, scale, and orientation are filtered out from the database. The drawback of SIFT is the computation involves calculation of pixel patch value based on the histogram of gradients. Hence, if the image size is large then computation becomes expensive.

$$E(u, v) = \sum_{x,y} w(x, y)[I(x + u, y + u) - I(x, y)]^2 \quad (1)$$

- **Oriented FAST and Rotated BRIEF(ORB)**

ORB is one of the local feature extraction methods that overcomes the drawback of SIFT and reduces the computation time. It is based on the BRIEF (Binary robust independent elementary features) and FAST point detector [21]. The points are detected in the image based on the orientation. Initially, the point is located at the center of the corner of the image. The orientation of the image is known from this point. The invariance is improved using the circular region of the image. The description of the images is set using the points detected using FAST point detector. A matrix S ($2 \times n$) defines the coordinates of the pixels from the feature set. The orientation Θ found using FAST point rotates the matrix S to a steered version S_{Θ} . A lookup table is first precomputed using the angle $2\pi/30^\circ$ to produce the correct set of points S_{Θ} . A small snippet of the code is as shown below.

The image is read initially inputted in grayscale but can be converted to RGB later. The ORB local feature extractor is defined and to specify the number of features that are needed to pick up. Initially, it's set to the top 1000 features, if left blank if finds all the possible features. All the points of interest in the image are computed and stored in the variable "kp". A plot is defined for these feature points stored in "kp" on the original image, these points are marked in a single color as specified in the parameters list. In the end, output can be viewed using the imshow() function in matplotlib. The output of a sample image is as shown in Fig. 3.

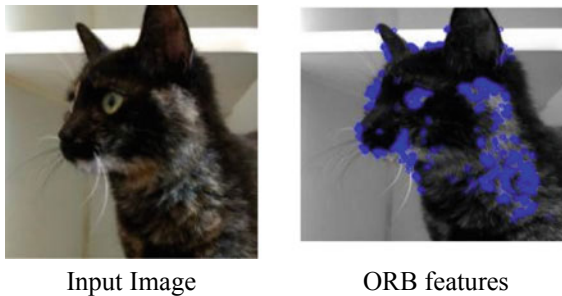

Fig. 3 ORB sample output

```

import cv2
import matplotlib.pyplot as plt
filename='5.jpg' #filename of the image
img = cv2.imread('5.jpg',0)
orb = cv2.ORB(nfeatures=1000) #defines how many features
to pick
kp = orb.detect(img,None)
kp, des = orb.compute(img, kp)
img2 = cv2.drawKeypoints(img,kp,color=(255,0,0), flags=0)
#plot all the points of interest on the image
plt.figure(figsize=(16, 16))
plt.title('ORB Interest Points')
plt.imshow(img2) #print image with highlights
plt.show()

```

5.2 Global Feature Extraction Methods

Once the local features such as edges of the images/dataset are extracted from the image global features are computed for the entire image. These global features help in the final classification of the image using the computed elements of the local features. The common methods that are used in extracting global features of the dataset/image are as follows:

- **Histogram of Oriented Gradients (HOG)**

HOG is used as feature descriptor in image processing and computer vision for object detection. It is based on the histogram of gradients that acts as a global feature for object detection. In local portions of the image, it counts the occurrences of gradient orientation to produce the histogram. The intensity of the distribution of histograms present in the local object appearances guides the production of the histograms [22]. Basically, in an image, each pixel is drawn into a group of cells. A histogram of gradients is compiled for each pixel in the cell. A descriptor forms the concatenation of all these histograms. The different types of gradients that are followed in HOG are listed as follows.

- **Image gradients**

A gradient is a vector quantity that has both magnitude and direction. An image gradient gives the intensity change at the particular location of the image. An illustrative image gradient is as shown in Fig. 4.

- **Histogram of oriented gradients**

When the gradients of the image are oriented, it is called as oriented gradients. A histogram of oriented gradients gives the intensity of the gradients of the

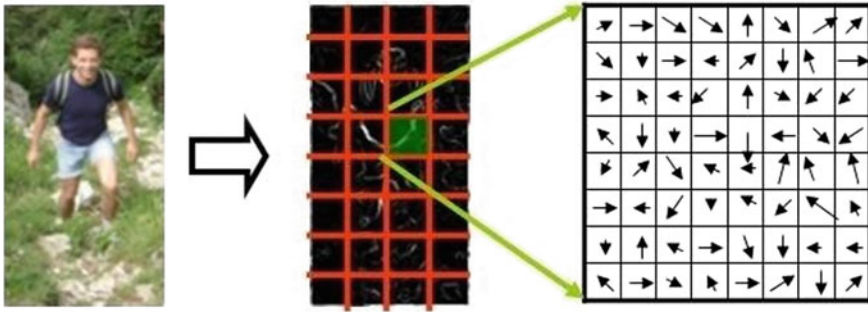

Fig. 4 Image gradient

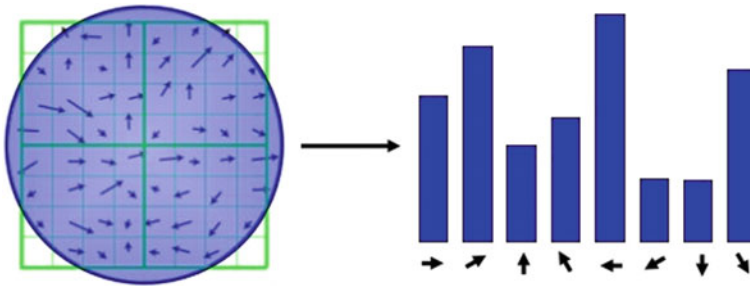

Fig. 5 Histogram of oriented gradients

small portion of the image. It helps to find the probability of a gradient in the particular portion of the image as shown in Fig. 5.

A small snippet of Histogram of oriented gradients is as shown below. The required libraries are imported, including the HOG detector function from the skimage library. Here, `img` is the image being read, `orientation` is the number of directions for features in terms of intensity fluctuation, `pixels_per_cell` divides picture into cells and define the number of pixels per cell, `cells_per_block` is the number of cells taken per block for mapping, `visualize` is to get final image of feature detection, `feature_vector` is to output the final feature vector, “`feat`” is the feature set and “`im`” is the histogram. The output of a sample image is as shown in Fig. 6a–c.

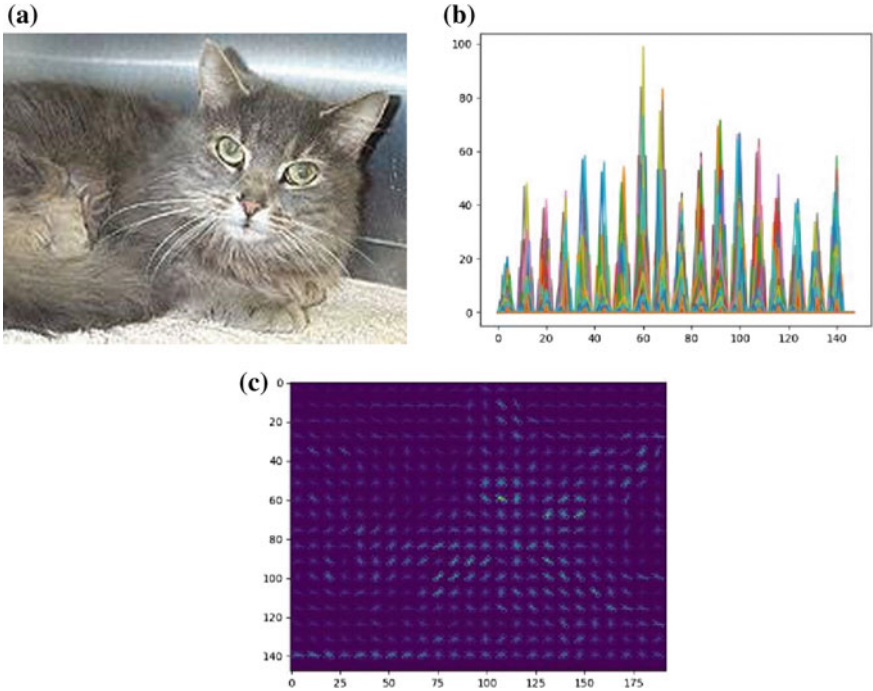

Fig. 6 a Input for HOG b Histogram for HOG sample output c Features for HOG sample output

```
import cv2
import matplotlib.pyplot as plt
from skimage.feature import hog
img = cv2.imread("7.jpg",0) #read image
feat,im=hog(img,orientations=9,pixels_per_cell=(8,8),cell
s_per_block=(2,2), visualise=True,feature_vector=True)
#img is image being read
#orientation the number of directions for features in
terms of intensity fluctuation
#pixels_per_cell divide picture into cells and define the
pixel density
#cells_per_block number of cells taken per block for
mapping
#visualise get image of feature detection
#feature_vector
plt.plot(im) #plot histogram for detection
plt.show() #show histpgram graph
```

6 Deep Learning for IoT Data Classification

6.1 *IoT Data and Its Types*

Internet of things is composed of various devices capable of receiving data and may or may not possess computing power. These devices are interconnected and are usually in constant communication with each other. Thus as a natural consequence always keep generating data. The devices participating in an IoT network can be majorly classified into two types. The first of them which forms the building blocks of the network are the sensors and second one of them are the devices which consume the data acquired from the sensors. These devices that consume the data can be further distinguished as ones which perform analysis based on the retrieved data or initiate an action based on the acquired data. On the whole, IoT data that is being generated by sensors play a major role in powering various kinds of applications.

From the natural understanding of the behavior of devices that participate in IoT, a norm can be derived for classifying IoT data. Thus this basic classification of IoT data yields two categories namely

1. Data used for analysis purposes (Analysis data)
2. Data used to initiate an action (Actuation data or action causing data)

6.1.1 Analysis Data

The volume of data generated from a wide array of sensors provides an excellent platform to perform analysis. Various kinds of sensor data are available ranging right from trivial data obtained from simple motion sensors to a more sophisticated form of data such as location data obtained from smartphones. The data obtained will usually be in the form of time series data which has a natural consequence of having a higher volume.

A classical example that can be illustrated in the case of analysis of IoT data is that of study of meteorological data. It consists of study of atmosphere and its constituents and various related analysis such as weather patterns, rainfall magnitudes, and so on. Various predictions are also undertaken based on this data which is clearly evident in the form of weather updates, rainfall predictions, and temperature range suggestions. Another similar example will be the analysis of chemical constituents of air and analyzing the overall air quality.

Various other domains also provide good scope for data analysis which includes multimedia sources. This vast domain has a huge disposal of data which exists in various forms. This includes real-time traffic data, text, and images from various social media platforms. Another domain which provides a platform to obtain statistics are the various routers, switches, and other networking devices deployed across the globe. Modern SDN systems have device statistics built into them to enable analysis and to infer congestion levels and other such parameters. A variety of medical

equipments also participate in generating data such as electrocardiography, blood test reports, x-rays, etc., which can be used for analysis purpose when viewed at a large scale. Call records of mobile phones and the usage times of different applications can also be considered as a contributor. The insights obtained after performing analysis are usually used for commercial purposes or can be utilized by the government.

6.1.2 Actuation Data or Action Causing Data

Apart from aiding various analytics applications, IoT data is also being used to actuate other devices in order to obtain a desirable action or a mechanism which drives a decision. This form of utility is being exploited in areas such as automation systems and in networking scenarios, as a solution mechanism for congestion problems.

As an example, in the case of automation systems, a simple home automation system serves the purpose of understanding decision driving mechanisms. The heating and illumination systems present in a typical house such as normal light bulb, or a fan can be made alternate between on and off state based on the data collected by sensors deployed in the house which include motion sensors, thermostats, and related sensors.

As an example in the case of networking scenarios, the routing information stored in the edge devices and the records of data or packets passing through the device can be retrieved. This information can be used to enable rerouting bringing about load balancing and thereby enabling congestion control.

6.2 Case Study on IoT Data Classification Using Deep Learning

6.2.1 IoT Dataset

The dataset chosen for classification purpose is “Air Quality Dataset” [23]. It is a fairly sized dataset of 9358 instances. The quality of air is determined by the relative composition of its constituent elements. The data collected here can be categorized as IoT data since it has accumulated by the various sensors. The device used to form the dataset is an Air Quality Chemical Multisensor Device. It is composed of five metal oxide chemical sensors which are arranged to form the device.

Data was gathered on an hourly basis in order to obtain a sizeable dataset and which represents adequate variation. The sensor was placed in an Italian city which was subject to a relatively higher level of pollution due to the presence of various pollutants. The duration of data capture ranged from March 2004 to February 2005. This data represents one whole year of recording which is regarded as the longest duration in which chemical sensors were deployed which captured air quality.

The dataset consists of the following attributes:

1. Date (DD/MM/YYYY)
2. Time (HH.MM.SS)
3. True hourly averaged concentration CO in mg/m^3 (reference analyzer)
4. PT08.S1 (tin oxide) hourly averaged sensor response (nominally CO targeted)
5. True hourly averaged overall Non-Metanic HydroCarbons concentration in microg/m^3 (reference analyzer)
6. True hourly averaged Benzene concentration in microg/m^3 (reference analyzer)
7. PT08.S2 (titania) hourly averaged sensor response (nominally NMHC targeted)
8. True hourly averaged NO_x concentration in ppb (reference analyzer)
9. PT08.S3 (tungsten oxide) hourly averaged sensor response (nominally NO_x targeted)
10. True hourly averaged NO₂ concentration in microg/m^3 (reference analyzer)
11. PT08.S4 (tungsten oxide) hourly averaged sensor response (nominally NO₂ targeted)
12. PT08.S5 (indium oxide) hourly averaged sensor response (nominally O₃ targeted)
13. Temperature in $\hat{\text{A}}^\circ\text{C}$
14. Relative Humidity (%)
15. AH Absolute Humidity

IoT data most of the times is captured with the help of various sensors. These sensors are usually physical which are deployed in sites. They can also be simulated via a python script for experimental or analysis purposes. These scripts which are deployed in edge devices act as an interface to simulate different kinds of sensors. The script shown below can be used to pump in sensor data.

The sensors deployed in edge devices need to pump in data to a central database. IoT devices communicate using a lightweight protocol called mqtt protocol. Two basic operations or functions associated with mqtt protocol are published and subscribed. These terms are analogous to write and read of an I/O device. A device or a sensor that needs to pump in data has to publish with a particular type under a predetermined topic. Similarly, devices that need to analyze or read this data need to subscribe to the topic. The mqtt broker plays a vital role or is essentially the heart of the protocol. It is responsible for sending and receiving messages and delivering it to the clients thereby responsible for the fundamental publish/subscribe model. In the script shown below data needs to be published and hence associated code has been incorporated.

```

import time
import paho.mqtt.client as mqtt
import json import ssl
import random
broker = "<broker_url here>"
port = 8883
topic = "iot-2/evt/test/fmt/json"
username = "<username>"
password = "<password >"
organization = "<org id here>"
deviceType = "Python_Client"

mqttc = mqtt.Client("<client id>") print(username+'
'+password)
mqttc.username_pw_set(username,password)
mqttc.tls_set_context(context=None)
mqttc.tls_insecure_set(False)
mqttc.connect(broker,8883,60)
for i in range(0,10):
    print('Sending sample key value pairs')
    msg={'key':i,'value':random.randrange(1,50)}
    mqttc.publish(topic,json.dumps(msg))
    time.sleep(1)

```

The supporting libraries for implementing the mqtt protocol and establishing a secure channel for communication have been imported. A suitable port number and a desired device type has been chosen. Among the various mqtt brokers available, an apt broker according to the application is to be chosen. The above script simulates a sample sensor and hence accordingly a generic key-value pair is taken as the reading of the sensor and a sample topic name is chosen. The key-value pairs usually denote the (time period, sensor value) of a typical sensor. This generic sensor can be considered as a temperature gauge, or an accelerometer, in simple terms a gravity sensor which is present on most modern day smartphones. These virtual sensors can be used for sample analytics purposes and to suit real life requirements, they are replaced by actual sensors that are deployed in the region of study.

6.2.2 Building Neural Network for Classification

Many problems like Email spam, Handwriting digit recognition, Fraud transaction detection are important day to day example of Classification problems. Classification in simple terms, is grouping of things by a common features, characteristics, and qualities. To solve this problem there are many classification algorithms like decision tree, logistic regression, and k-nearest neighbors. However, Neural Network has few benefits when compared to others therefore, it is the most popular choice to handle real-time big data. The benefits of neural network are:

- Normal Machine learning algorithm will reach a plateau, and will not improve much with more data after a certain point. However, neural network improves with more data to train
- Neural Network is a nonlinear model, which helps us to define complex hyper plane, nontrivial decision boundaries for solving convoluted classification problem.
- Neural network is highly adaptive can deal with nonstationary environments.
- Neural network has high Fault tolerance. Corruption of few neurons does not restrict it from generating the output.
- Every neuron has a potential to influence every other neuron in the network. Therefore, Contextual information is dealt naturally.

Due to all the reasons above, artificial neural network is being actively employed in lot of real-world problems like classifying spam emails, Bankruptcy prediction, flagging fraud transaction, etc., and are getting better results than conventional algorithms.

6.2.3 Experiment and Results

A sample dataset is as shown in Table 2. Artificial neural network is a network of neurons. They process the training data one at time and learn by comparing their classification predicted with the actual classification. The errors from initial classification are fed back into the network to correct itself and modify weights for further iteration. Therefore, the major difficulty in building neural network is to find the most appropriate grouping of training, learning, and transfer functions to get the best result.

Before we can build a network, we have process the dataset by classifying all NO₂(GT) columns to two classes. 1 for higher and 0 for lesser than 100 air quality index as shown in Table 3.

Table 2 Air quality data set

Date	Time	CO(GT)	PT08.S1 (CO)	NMHC(GT)	C6H6(GT)	PT08.S2 (NMHC)
10-03-2004	18.00.00	2.6	1360	150	11.9	1046
10-03-2004	19.00.00	2	1292	112	9.4	955
10-03-2004	20.00.00	2.2	1402	88	9	939
10-03-2004	21.00.00	2.2	1376	80	9.2	948
10-03-2004	22.00.00	1.6	1272	51	6.5	836

Table 3 Preprocessing of data

Date	Time	NO2(GT)	T
10-03-2004	18.00.00	1	13.6
10-03-2004	19.00.00	0	13.3
10-03-2004	20.00.00	1	11.9
10-03-2004	21.00.00	1	11.0
10-03-2004	22.00.00	1	11.2

```
data=df[['Date','Time','NO2 (GT)', 'T']].copy()
for i in range(len(data)):

    if (data.iloc[i]['NO2 (GT)']<100):

        data.at[i,'NO2 (GT)']=0 else:
            data.at[i,'NO2 (GT)']=1
```

Next, we need input features like weekday and hour to extract from date and time column as shown in Table 4. We can split the dataset into training set and testing set.

```
for i in range(len(data)):
    time=datetime.datetime.strptime(data.iloc[i]['Date']
    ]+" "+ data.iloc[i]['Time'], "%d/%m/%Y %H:%M:%S")
    weekday=time.weekday()
    hour=time.hour
    data.at[i,'Weekday']=weekday
    data.at[i,'hour']=hour
    data.Weekday = data.Weekday.astype(int)
    data.hour = data.hour.astype(int)
    train, test = train_test_split(data, test_size=0.2)
    train.to_csv("train.csv",mode="w",index=False)
    test.to_csv("test.csv",mode="w",index=False)
```

Table 4 Preprocessing of data with day and hour

Date	Time	NO2(GT)	T	Weekday	Hour
10-03-2004	18.00.00	1	13.6	2	18
10-03-2004	19.00.00	0	13.3	2	19
10-03-2004	20.00.00	1	11.9	2	20
10-03-2004	21.00.00	1	11.0	2	21
10-03-2004	22.00.00	1	11.2	2	22

We will use tensor flow high level API to build a simple neural network with an input layer (4 nodes) and a output layer. To that, we have to first write a function to extract the training dataset.

```
def load_traindata(label_name='NO2 (GT)'):
    train_path="train.csv" # For Training NN model
    CSV_COLUMN_NAMES=
    ['Date', 'Time', 'NO2 (GT)', 'T', 'Weekday', 'hour']
    train = pd.read_csv(filepath_or_buffer=train_path,
        names=CSV_COLUMN_NAMES, # list of column names
        header=0, # ignore the first row of the CSV file.
        skipinitialspace=True,
        skiprows=1
    )
    train.pop('Time')
    train.pop('Date')
    train['hour'] = train['hour'].astype(str)
    train.Weekday= train.Weekday.astype(str)
    train['T']= train['T'].astype(float)
    train_features,train_label=train,train.pop(label_n
ame)
    return (train_features,train_label)

#getting training features and labels
(train_feature,train_label)= load_traindata()
```

To give a input features to we have to give it in the form of `tf.feature column`. This feature consist can be categorical (Weekday, hour) or numerical (Temperature T) also. If two or more input features are closely related, it can be a separate feature in itself. This type of columns is known as crossed column (weekday x_hour), which is mixture of two or more input features. After deciding the input features we create a Simple DNN classifier with base columns and crossed columns. Hidden unit indicates the no of nodes in each layer (for example [3–5] indicates a neural network with input layer with 4 nodes, hidden layer with 3 nodes and hidden layer 2 with 2 nodes). We need a hidden layer if the data is not linearly separable. Number of input nodes depends on number of input features and, similarly, number of output nodes depends on number of classes being in output label.

```

#creating normal features and crossed features for the
nn model
Weekday =
tf.feature_column.categorical_column_with_vocabulary_list
('Weekday', ['0', '1', '2', '3', '4', '5', '6'])
hour =
tf.feature_column.categorical_column_with_vocabulary_list
('hour', [ '0','1','2', '3','4','5','6','7','8','10',
'12','13','14','15','16','17','18','19','20','21','22',
'23'])
T=
tf.feature_column.numeric_column(key='T',dtype=tf.float
64)
base_columns = [
    tf.feature_column.indicator_column(Weekday),
    tf.feature_column.indicator_column(hour),
    T
]
Weekday_x_hour = tf.feature_column.crossed_column(
    ['Weekday', 'hour'], hash_bucket_size=1000)
crossed_columns = [
    tf.feature_column.indicator_column(Weekday_x_hour)
]
# Running Dnn classifier model with the features
designed
# Above and with and input layer with 4 nodes

classifier =
tf.estimator.DNNClassifier(feature_columns=
base_columns+crossed_columns,hidden_units=[4],n_
classes=2)

```

We have to train the classifier by passing a `train_input` function which shuffles the input training data features. We have to iterate through the process (epoch) until the classifier reaches its minimum error rate. Here we have chosen to iterate 50 times.

```

#training the nnmodel
def train_input_fn(features, labels, batch_size):
    dataset =
    tf.data.Dataset.from_tensor_slices((dict(features) ,
    labels))
    dataset=
    dataset.shuffle(buffer_size=1000).repeat(count=None
    ).batch(batch_size)
    return
    dataset.make_one_shot_iterator().get_next()

```

```

classifier.train(
    input_fn=lambda:train_input_fn(train_feature,
    train_label, 50 ),steps=1000)

```

Neural Network Training

```

INFO:tensorflow:Callingmodel_fn.
INFO:tensorflow:Done calling model_fn.
INFO:tensorflow:CreateCheckpointSaverHook.
INFO:tensorflow:Graph was finalized.
INFO:tensorflow:Runninglocal_init_op.
INFO:tensorflow:Done running local_init_op.
INFO:tensorflow:Saving checkpoints for 1 into
C:\Users\Guest\AppData\Local\Temp\tmprvw147wc\model.ckpt.
INFO:tensorflow:step = 1, loss = 42.49231
INFO:tensorflow:global_step/sec: 48.6003
INFO:tensorflow:step = 101, loss = 30.568665 (2.062
sec)
INFO:tensorflow:global_step/sec: 55.7494
INFO:tensorflow:step = 201, loss = 25.75341 (1.793 sec)
INFO:tensorflow:global_step/sec: 57.967
INFO:tensorflow:step = 301, loss = 24.957882 (1.726
sec) INFO:tensorflow:global_step/sec: 57.7436
INFO:tensorflow:step = 401, loss = 29.967522 (1.732
sec) INFO:tensorflow:global_step/sec: 58.4679
INFO:tensorflow:step = 501, loss = 27.571487 (1.711
sec)
INFO:tensorflow:global_step/sec: 53.1789
INFO:tensorflow:step = 601, loss = 25.81527 (1.875 sec)
INFO:tensorflow:global_step/sec: 54.6941
INFO:tensorflow:step = 701, loss = 19.551216 (1.833
sec) INFO:tensorflow:global_step/sec: 56.3506
INFO:tensorflow:step = 801, loss = 27.794727 (1.776
sec) INFO:tensorflow:global_step/sec: 59.6893
INFO:tensorflow:step = 901, loss = 21.918167 (1.673
sec)
INFO:tensorflow:Saving checkpoints for 1000 into
C:\Users\Guest\AppData
\Local\Temp\tmprvw147wc\model.ckpt.
INFO:tensorflow:Loss for final step: 24.991734.

```

After training the classifier we can test it by passing it test data input features, in a similar way as we train. We have to pass a function which evaluate_input function to pass only the input feature to classifier and classifier predicts the output.

```

#predicting for all time intervals in a day with the
trained
test_df=pd.read_csv("test.csv",parse_dates=True)
predict_x= {
    'T':[],
    'Weekday':[],
    'hour':[ ],
}
predict_x['T'] = test_df['T'].astype(float)
predict_x['hour']= test_df.hour.astype(str)
predict_x['Weekday']= test_df.Weekday.astype(str)
test_label=test_df['NO2(GT)']

def eval_input_fn(features, labels=None,batch_size=None):
    """An input function for evaluation or prediction"""
    if labels is None:
        # No labels, use only features.
        inputs = features
    else:
        inputs = (features, labels)
        # Convert inputs to a tf.dataset
        object.
        dataset=tf.data.Dataset.from_tensor_
        slices (inputs)
        # Batch the examples
        assert batch_size is not None, "batch_size must
        not be None"
        dataset = dataset.batch(batch_size)
        # Return the read end of the pipeline.
        return
        dataset.make_one_shot_iterator().get_next()

predictions = classifier.predict(
input_fn=lambda:eval_input_fn(predict_x,
    labels=None, batch_size=50))

pred_label=[]
for pred_dict in zip(predictions):
    if pred_dict[0]['classes'] == [b'1']:
        pred_label.append(1)
    else:
        pred_label.append(0)

```

Since the problem chosen is a binary classification we can check the results by finding the confusion matrix for the test data. Confusion matrix is table which contains true positives, false positive, true negative, and false negative as shown in Table 5.

Table 5 Confusion matrix

	Predicted positive	Predicted negative
Actual positive	692	303
Actual negative	169	708

We get the sensitivity and specificity with which classifier classifies the test data. We can also represent the confusion matrix in the form of a graph as shown in Fig. 7.

```
#plotting a confusion matrix with the tested data
def plot_confusion_matrix(cm, names, title='Confusion
matrix', cmap=plt.cm.Blues):
plt.imshow(cm, interpolation='nearest', cmap=cmap)
plt.title(title)
plt.colorbar()
tick_marks = np.arange(len(names))
plt.xticks(tick_marks, names, rotation=45)
plt.yticks(tick_marks, names)
plt.tight_layout()plt.ylabel('True label')
plt.xlabel('Predicted label')
con_mat =tf.confusion_matrix(test_label,pred_label)
cm=[]
with tf.Session():
    cm=tf.Tensor.eval(con_mat,feed_dict=None,
        session=None)
```

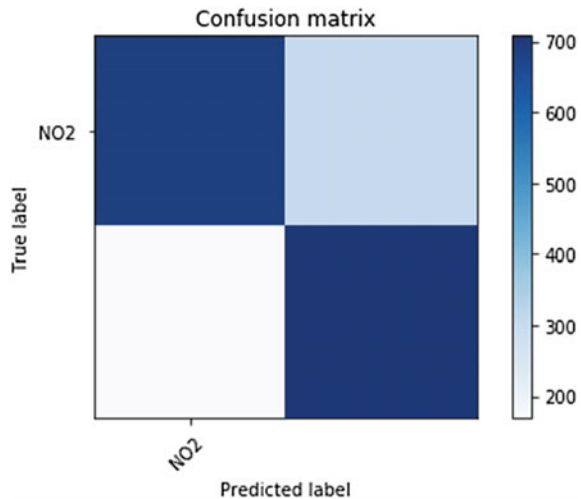
Fig. 7 Visual representation of confusion matrix

```
plt.figure()  
  
diagnosis=["NO2 "]  
plot_confusion_matrix(cm, diagnosis)
```

We can also test our results of our classifier using a ROC (Receiver Operating Characteristic) curve. ROC curve is a graphical way to show the cutoff between sensitivity (fraction of true positives) and specificity (fraction of true negatives). The area under Roc curve is a measure of usefulness of test, therefore greater AOC means better result as shown in Fig. 8.

```
# Plot an ROC. pred - the predictions, y - the expected  
output. def plot_roc(pred,y):  
fpr, tpr, _ = roc_curve(y, pred)  
roc_auc = auc(fpr, tpr)  
print("Auc of classifier is ")  
print(roc_auc)  
plt.figure()  
plt.plot(fpr, tpr, label='ROC curve (area = %0.2f) '  
         % roc_auc)  
plt.plot([0, 1], [0, 1], 'k--')  
plt.xlim([0.0, 1.0])  
plt.ylim([0.0, 1.05])  
plt.xlabel('False Positive Rate')  
plt.ylabel('True Positive Rate')  
plt.title('Receiver Operating Characteristic (ROC)')  
plt.legend(loc="lower right")  
plt.show()  
plot_roc(pred_label,test_label)
```

Fig. 8 Visual representation of ROC curve

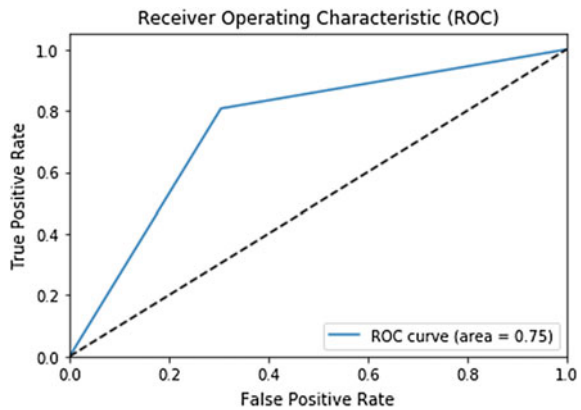

7 Conclusion

Since IoT devices are increasing day by day multimedia data from different sensors such as video, audio, phone, and others need to be processed in real time. If the data generated is not collected and analyzed then the value of the data may not be known. Thus, deep learning methods are very essential for analysis of multimedia data and IoT for different applications. In this chapter, a brief introduction to multimedia data and its types were initially mentioned. The different deep learning methods with local feature extraction and global feature extraction were discussed with small snippets of examples. Finally, a case study on air quality monitoring presented the deep learning method of classification and analysis of the data.

References

1. A. Kumari, S. Tanwar, S. Tyagi, N. Kumar, M. Maasberg, K.-K.R. Choo, Multimedia big data computing and Internet of Things applications: a taxonomy and process model. *J. Netw. Comput Appl.* (2018)
2. P.K. Atrey, M. Anwar Hossain, A. El Saddik, M.S. Kankanhalli, Multimodal fusion for multimedia analysis: a survey. *Multimed. Syst.* **16**(6), 345–379 (2010)
3. J. Gubbi, R. Buyya, S. Marusic, M. Palaniswami, Internet of Things (IoT): a vision, architectural elements, and future directions. *Future Gener. Comput. Syst.* **29**(7), 1645–1660 (2013)
4. C.A. Bhatt, M.S. Kankanhalli, Multimedia data mining: state of the art and challenges. *Multimed. Tools Appl.* **51**(1), 35–76 (2011)
5. F. Venter, A. Stein, Images & videos: really big data. *Anal. Mag.* 14–47 (2012)
6. D. Che, M. Safran, Z. Peng, From big data to big data mining: challenges, issues, and opportunities, in *Database Systems for Advanced Applications* (Springer, Wuhan, China, 2013), pp. 1–15
7. Z. Wu, M. Zou, An incremental community detection method for social tagging systems using locality-sensitive hashing. *Neural Netw.* **58**(1), 12–28 (2014)
8. P.K. Atrey, N.C. Maddage, M.S. Kankanhalli, Audio based event detection for multimedia surveillance, in *2006 IEEE International Conference on Acoustics Speech and Signal Processing Proceedings*, vol. 5 (IEEE, 2006)
9. NLTK, <https://www.nltk.org/>
10. Scikit learn, <http://scikit-learn.org/>
11. Hadoop, <https://hadoop.apache.org/>
12. Spark, <https://spark.apache.org>
13. J. Herrera, G. Molto, Detecting events in streaming multimedia with big data techniques, in *2016 Proceedings of 24th Euromicro International Conference on Parallel, Distributed, and Network-Based Processing (PDP)*, Heraklion Crete, Greece (2016), pp. 345–349
14. S. Hershey, S. Chaudhuri, D.P. Ellis, J.F. Gemmeke, A. Jansen, R.C. Moore, M. Plakal, D. Platt, R.A. Saurous, B. Seybold et al., CNN architectures for large-scale audio classification, in *2017 IEEE International Conference on Acoustics, Speech and Signal Processing (ICASSP)* (IEEE, 2017), pp. 131–135, <https://www.tableau.com/> (14. Tableau)
15. OpenCV, <https://opencv.org/>
16. Librosa, <https://librosa.github.io/librosa/>
17. K. Alex, I. Sutskever, E.H. Geoffrey, *ImageNet Classification with Deep Convolutional Neural Networks* (2012), pp. 1097–1105
18. J. Schmidhuber, Deep learning in neural networks: an overview. *Neural Netw.* **61**, 85–117 (2015)

19. C. Harris, M. Stephens, A combined corner and edge detector, in *Alvey Vision Conference*, vol. 15, no. 50 (1988), pp. 10–5244
20. T. Lindeberg, Scale invariant feature transform (2012)
21. E. Rublee, V. Rabaud, K. Konolige, G. Bradski, ORB: an efficient alternative to SIFT or SURF, in *2011 IEEE International Conference on Computer Vision (ICCV)* (IEEE, 2011), pp. 2564–2571
22. N. Dalal, B. Triggs, Histograms of oriented gradients for human detection, in *IEEE Computer Society Conference on Computer Vision and Pattern Recognition, 2005, CVPR 2005*, vol. 1 (IEEE, 2005), pp. 886–893
23. Air quality data, <https://archive.ics.uci.edu/ml/datasets/Air+quality>

Random Forest-Based Sarcastic Tweet Classification Using Multiple Feature Collection



Rajeev Kumar and Jasandeep Kaur

Abstract Sarcasm is primary reason behind the faulty classification of the tweets. The tweets of sarcastic nature appear in the different compositions, but mainly deflect the meaning different than their actual composition. This confuses the classification models and produces false results. In the paper, the primary focus remains upon the classification of sarcastic tweets, which has been accomplished using the textual structure. This involves the expressions of speech, part of speech features, punctuations, term sentiment, affection, etc. All of the features are extracted individually from the target tweet and combined altogether to create the cumulative feature for the target tweet. The proposed model has been observed with accuracy slightly higher than 84%, which depicts the clear improvement in comparison with existing models. The random forest-based classification model has outperformed all other candidates deployed under the experiment. The random forest classifier is observed with accuracy of 84.7, which outperforms the SVM (78.6%), KNN (73.1%), and Maximum entropy (80.5%).

Keywords Text analytics · Supervised text classification · Sarcasm detection · Support vector machine · Punctuation features · Affection analysis

1 Introduction

The field of study which focuses on the interactions of human language and computers is natural language processing. NLP mainly focuses on the intersection of artificial intelligence, computer science, and computational linguistics. To examine, understand, and conclude importance and definition in a wise manner from human language, NLP uses computers. By using NLP, knowledge can be structured and

R. Kumar · J. Kaur (✉)

DAV Institute of Engineering and Technology, Jalandhar, Punjab, India
e-mail: Kaurjasandeep@gmail.com

R. Kumar

e-mail: Rajeev.daviet@gmail.com

© Springer Nature Singapore Pte Ltd. 2020
S. Tanwar et al. (eds.), *Multimedia Big Data Computing for IoT Applications*, Intelligent Systems Reference Library 163,
https://doi.org/10.1007/978-981-13-8759-3_5

analyzed to do different things like translation, automatic summarization, sentiment analysis, speech recognition, and topic segmentation. NLP is required to analyze text, allowing machine to know how human speaks. It is required for machine translation, automatic question answering, and mining. The exactness in human language is rare and this is the most difficult problem for NLP in computer science. The connection between human and machine is required to know its meaning and not by simply understanding the words. The ill-defined part of language makes NLP a critical task for computers to master and not the learning of language which is quite easy for individuals to learn. On machine learning algorithms NLP is developed. NLP can rely on machine learning than hand-coding big set of rules for automated rule learning by examining a pair of references such as down to a collection of sentences, a large corpus etcetera, and make predictions statistically. To infer, more the information is examined, more the model will be explicit.

1.1 Applications of NLP

- Machine translation

The procedure through which the conversion of source language text to the target language is done is known as Machine Translation. The pictorial representation below defines all the stages which define it that is from source text to target text [1].

- Automatic summarization

Information overload becomes a problem when humans require acquiring a specific and significant detail from a large amount of knowledge base. Therefore, this application not only understands the emotional meaning containing in the context but also conclude the definition, e.g., gathering information from Social Media.

- Sentiment analysis

To search sentiment among several posts or in the same post in which feeling is not always exhibited clearly, sentiment analysis is used. NLP applications are used by many companies such as this method to know sentiment and opinions electronically through computer to assist to know the thinking of the users related to their products or services. To exemplify, “I love the new Samsung phone” and further wrote “However, it does not sometimes operate well” in this example, an individual is mentioning about the phone along with final benchmarks of its image.

- Text classification

To get the detail which is significant or which can ease few things by permitting predefined categories to a document and fit them is feasible through this classification only.

To exemplify: Spam filtering in email.

- Question answering

For answering the human request, the term of question answering is a capable system and for its popularity, the major gratitude goes to Siri, OK Google, and Chat boxes. It provides authenticity and will go long in the upcoming time, therefore this will remain a challenging task for searching devices and will remain the crucial term of NLP research.

1.2 Introduction to Sentiment Analysis

Sentiment analysis is a process to obtain valuable information or sentiment from data. It uses various techniques like text processing, text analysis, natural language, and computational linguistics to process the data. The motive is to find out polarity of a document by analysis of data inside the document. The polarity of document is according to the opinion of the document and that can be either positive or negative or can be neutral polarity. Sentiment analysis is categorized into 3 main areas which are mentioned below.

Sentiment analysis faces many challenges and one of them is sarcasm Detection. As sentiment analysis can be misguided due to the presence of words that have a strong polarity and used as sarcastically, which intended the opposite polarity. Sarcasm is a form of speech in which the speakers convey their message in an implicit way. Sometimes, the naturally uncertain nature of sarcasm makes it hard for humans to decide whether a sentence is sarcastic or not and also it conveys a negative opinion using only positive words or intensified positive words. Therefore, the detection of sarcasm is important for the development and refinement of sentiment analysis (Fig. 1).

1.3 Introduction to Sarcasm Detection

Sarcasm is a verbal device, with the intention of putting someone down or is an act of saying one thing while the meaning is opposite. It is mostly used on social media to make a remark that means the opposite of what they say, in order to hurt

Fig. 1 Different sentiment analysis levels

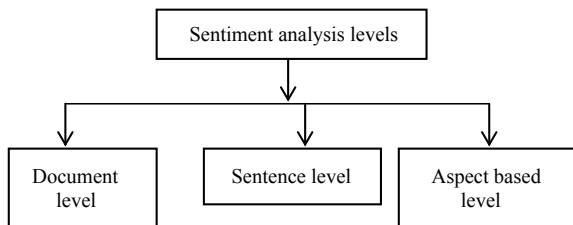

someone's feelings. The polarity of the statement is also transformed by sarcasm into its opposite. For instance, if someone says, "You have been working hard," he said with heavy sarcasm as the person looked at the empty page.

Phases of sarcasm detection:

- **Dataset Formation:** It is the first step in which dataset can be collected from different sources, e.g., Twitter or posts from Facebook.
- **Data Preprocessing:** In this case, cleaning of data is performed such as removal of URLs, hashtags, tags in the form of @user and unnecessary symbols.
- **Sarcasm Identification:** It involves two different phases, i.e., feature selection and feature extraction. Feature extraction involves Part of speech (), Term presence, Term frequency, Inverse document frequency, Negation and opinion expressions for extracting the features. On the other hand, the lexicon method and statistical method are used in case of feature selection.

1.4 Sarcasm Classification Approaches

Sarcasm analysis can be implemented using:

- i. Machine Learning Approach
- ii. Lexicon Based Approach
- iii. Hybrid Approach

1.4.1 Machine Learning

It is a field of artificial intelligence that trains the model from the current data in order to predict future outcomes, trends, and behaviors with the new test data. Machine Learning is categorized into Supervised and Unsupervised Learning.

Supervised Learning

Supervised Learning is used when there is a finite set of classes. In this method, labeled data is needed to train classifiers. In a machine learning based classifier, a training set is used as an automatic classifier to learn the different characteristics of documents, and a test set is used to validate the performance of the automatic classifier. Two steps are involved, i.e., training and testing.

Unsupervised Learning

This method is used when it is hard to find labeled training documents. It does not depend upon prior training for mine the data. In document level, SA is based on deciding the semantic orientation (SO) of particular phrase within the document. If the average semantic orientation of these phrases is above some predefined threshold, then the document is classified as positive, otherwise it is deemed negative.

1.4.2 Lexicon Based Techniques

One of the unsupervised techniques of sentiment analysis is lexicon based technique. There has been a lot of work done based on lexicon. In this classification is performed by comparing the features of a given text in the document against sentiment lexicons. The sentiment values are determined prior to their use. Basically, the sentiment lexicon consists of lists of words and expressions that are used to convey people's subjective feelings and opinions. Three methods to construct sentiment lexicon are:

Manual Method

In this approach each opinion word, such as nice (adjective), fast (adverb), love (verb), is selected manually and the corresponding polarity is assigned. This manual approach is a little time consuming and that is why it is never used alone.

Dictionary Based Method

This approach has three steps. In the first step, opinion words are constructed with their sentiment orientations manually. Then, in the second step, the seed list is grown by searching for synonyms and antonyms of seed words in a dictionary that is available online such as WordNet. The search results are combined with the seed list with the same polarity as their synonyms in the list or the opposite polarity of their existing antonyms, and the seeking process is started again until no new word is found in the dictionary. In the third step, a correction process is done manually to remove any existent errors. By using machine learning techniques and using additional information in WordNet such as "hyponym, -, it is possible to generate better and richer opinion words lists".

The most important drawback of this simple approach is that it is unable to distinguish between opinion words with respect to their domains. For example, "quiet" is expressing positive sentiment in the context of a car but a negative sentiment for a speakerphone.

Corpus-Based Method

This method is intended to solve the problem of the dictionary based approach. This method is intended to solve the problem of the dictionary based approach. It consists of two steps. The first step is constructing a seed list of opinion words which have adjective part of speech tags and their polarities. In the second step, a set of linguistic constraints is introduced to search for additional opinion words from the existing corpus as well as their sentiment orientations.

These linguistic constraints are based on the idea of “Sentiment Consistency.” According to sentiment consistency, people usually express the same opinions on both sides of conjunctions (for instance, “and”) and the opposite opinion around disjunctions (for instance, “but”). This idea helps to discover new sentiment words in a collection. For instance, in the sentence “This house is lovely and big.” If we do not have “big” in our seed list, we can conclude from “lovely” and conjunction (“and”) that “big” has the same polarity as “lovely.” Therefore, we can extend our list.

1.4.3 Hybrid Based Techniques

It involves a combination of other approaches namely machine learning and lexical approaches.

2 Literature Survey

Tanwar et al. [2] presented a huge amount of multimedia data also defined as MMBD is produced with a rapid incline in the supplying of multimedia devices over the invent of things in “Multimedia big data computing and Internet of Things applications: A taxonomy and process model.” In the present time, there research and development activities do not consider the complexity of MMBD over IoT rather focus on scaler sensor data. This process model mainly directs a number of challenges related to research such as accessibility, scalability, QoS, and reliability requirements.

A survey is presented by Jasandeep Kaur et al. on phases of sarcasm detection and also discusses various approaches based upon the combination of multiple features for classifying the text in “Text Analytical Models for Data Collected from Micro-blogging Portal—A Review”. Moreover, various classification algorithms are deployed for various text analytics systems, which are shortlisted on the basis of the feature engineering mechanism and type of data. For the data collected from Twitter, the Random Forest, SVM, and KNN are used with the punctuation-related, syntax-based, and other features for the sarcasm detection. The Random forest classifier is found the best in comparison with other classification models, where it outperforms the other model by minimum margin of 1.6% from KNN.

Shubhodip Saha et al. proposed an approach for sarcasm detection in Twitter in which textblob is used for preprocessing which includes tokenization, part of speech tagging, parsing, and by using python programming stop words are also removed. For polarity and subjectivity of tweets, RapidMiner is used and weka tool is used for calculating the accuracy of tweets using two classifiers, i.e., Naïve Bayes and SVM. At the end, naïve bayes provides more accuracy as compared to SVM.

A survey is provided by V. Haripriya et al. on various methodologies used to sarcasm detection in Twitter social media data and also done an analysis of various classifiers such as Naïve Bayes, Lexicon Based, and Support Vector Machine. Sarcasm can be determined efficiently only if the existing approaches can deal with large data set but most of the existing approaches can deal with only small datasets. So a deep learning approach is considered as an efficient approach to detect Sarcasm in case of large datasets.

Aditya Joshi et al. described datasets, approaches, trends, and issues in sarcasm detection. Datasets are divided into three classes: short text, long text, and other datasets approach like rule-based, statistical, deep learning-based, shared tasks are discussed and issues in data, issues with features, dealing with dataset skews are the issues for sarcasm detection.

Two approaches are presented by Aditya Joshi et al. in “Expect the unexpected: Harnessing Sentence Completion for Sarcasm Detection” that use sentence completion for sarcasm detection, one is all-words approach and other is incongruous words-only approach. Two datasets are used for the evaluation (i) tweets by [3] contains 2278 tweets out of which 506 are sarcastic annotated manually (ii) discussion forum posts by [4] 752 sarcastic and 752 non-sarcastic tweets manually annotated. For similarity measures, Word2Vec and WordNet similarities are used. The evaluation is configured into overall performance and twofold cross-validation. In overall performance, when Word2Vec similarity is used for the all-words approach an F-score of 54% is obtained but when WordNet is used in Incongruous words-only approach then F-score is 80.24%. In case of two-fold cross validation, when incongruous words-only approach and WordNet similarity are used then F-score is 80.28%.

A pattern-based approach is proposed by Mondher Bouazizi et al. for sarcasm detection on Twitter. They also proposed four different sets of features, i.e., Sentiment-related features, Punctuation-related features, Syntactic and Semantic features, and Pattern-based features. In this approach, the authors proposed more efficient and reliable patterns, i.e., words are divided into two classes: “CI” and “GFI” and this approach achieved 83.1% accuracy, 91.1% precision.

Different supervised classification technique is identified by Anandkumar D. Dave et al. in “A Comprehensive Study of Classification Techniques for Sarcasm Detection on Textual Data” for sarcasm detection and also train SVM classifier for 10X validation along simple Bag-of-words as features and use TFIDF for frequency measurement of the feature. Two datasets were collected (Amazon product reviews and tweets) and preprocessing also done for the removal of noise (spelling mistakes, slang words, user-defined label, etc.) present in the dataset.

An ensemble approach is introduced by Elisabetta Fersini et al. in “Detecting Irony and Sarcasm in Microblogs: The Role of Expressive Signals and Ensemble

Classifiers” in which BMA (Bayesian Model Averaging) along with different classifiers on the basis of their marginal probability predictions and reliabilities. The two main ensemble approaches, i.e., Majority Voting and Bayesian Model Averaging are considered to detect sarcasm and irony. In order to evaluate the proposed BMA approach, Fersini et al. [5] considered baseline classifier the one with the highest accuracy and four configurations: BOW, PP, POS, PP & POS, and the experimental result shows the proposed solution outperforms the traditional classifiers for the well-known Majority Voting mechanism and in this paper sarcasm can be better characterized by PoS tags or ironic statements are captured by pragmatic particles.

Tomas Ptacek et al. represent the first attempt at sarcasm detection on two different languages, i.e., Czech and English in “Sarcasm detection on Czech and English twitter.” For this two different datasets collected 140,000 tweets in Czech and 780,000 English tweets from Twitter Search API and Java Language Detection for the evaluation and two classifiers were used, i.e., Maximum Entropy and Support Vector Machine for the classification. Tests were organized in the 5-fold cross-validation and this approach achieved F-measure of 0.947 and 0.924 on the balanced and imbalanced datasets in English. SVM achieved good results, i.e., F-measure 0.582 on the Czech dataset with the feature set upgraded with patterns.

Two additional features are proposed by Edwin Lunando et al. in “Indonesian Social Media Sentiment Analysis with Sarcasm Detection” to detect sarcasm, i.e., number of interjection words and negativity information, after a common sentiment analysis is conducted. Three different types of experiments were conducted, i.e., experiments on sentiment score, experiments on classification method and experiments for sarcasm detection. In last experiment, the additional features evaluated in the sarcasm classification accuracy which shows that the additional features are effective in sarcasm detection.

A novel bootstrapping algorithm is presented by Ellen Riloff et al. in “Sarcasm as Contrast between a Positive Sentiment and Negative Situation” this naturally learn record of positive sentiment phrases and negative situation phrases from sarcastic tweets. Two baseline systems are created and to train SVM classifiers LIBSVM library is used and 10-fold cross-validation is used to evaluate the classifiers. The SVM achieved 64% precision and 39% recall with both unigram and bigram features and the hybrid approach, applying the contrast method with only positive verb phrases raises the recall from 39 to 42%.

Bruno Ohana et al. present sentiment analysis on film reviews by using hybrid approach which involves a machine learning algorithm namely support vector machine (SVM) and a semantic oriented approach namely sentiwordnet. The features are extracted from sentiwordnet. Training of support vector machine classifier is done on these features. Film reviews are classified by support vector machine afterward. To determine the sentiment orientation of the film reviews, counting of negative and positive term scores has been done.

2.1 Research Gaps

1. The word compression method used in the existing model can lower the performance of the sentiment analysis by removing the necessary bias and affecting the total emotion of the text data [6].
2. The existing model offers the accuracy of the nearly 83%, which carries a room for improvement and can be improved up to the higher level. The accuracy of the system can be improved by using the various improvements in the existing model. The system accuracy may be improved by using the above steps [6].
3. The existing model requires high computational power and slower the process of sentiment analysis. The proposed model can be extended to increase the process execution speed of the process. The existing model works in the various levels and uses the multivariate feature descriptors along with the classifier, which includes the overall elapsed time of the sentiment analytical system [6].
4. Only sentiment and emotion clues, which include the polarity and emoticon features, are used to detect the sarcasm in the existing scheme. It analyzes the existence of both positive and negative sentiment-related features, which may lead to false results in many cases [7].
5. The existing approach is best acceptable for the smaller text datasets, where the results have been proved to be efficient for Twitter with 140-word tweets. As Twitter has raised the number of allowed words from 140 to 280, this scheme is no longer efficient for the Twitter data. It must be improved for the larger text databases [8].
6. The sarcasm detection is based upon the different levels of sarcastic tweet in existing scheme. Sarcasm can't be properly described with the particular pre-defined set of rules; hence this scheme can't meet such requirement. A more generalized model can be a better option for sarcasm detection [9].

3 Proposed Methodology

3.1 To Create a Dataset for Sarcasm Detection

The dataset has been collected from Twitter using the Rest API, and the tweets are captured for the different streams, which includes different keywords for sarcasm, such as #sarcasm #sarcastic, etc. The normal tweets are collected from the natural discussion threads with keywords, such as #happy, #good, etc. A total of 25000 tweets are extracted from the Twitter API used as training data, and 609 tweets for testing purpose.

3.2 *Implementation*

The proposed work is implemented in Anaconda framework for complete sarcasm detection model. The configuration of the system is windows 8 (64-bit operating system) having an Intel i3 processor and 3 GB RAM. A detailed explanation of the implementation is done in this section.

3.2.1 **Feature Comparison Model**

The new model is designed for classifying tweet data into various categories, which involves the tweet data obtained from Twitter containing several tweets including non-sarcastic and sarcastic tweets. It is basically based upon the mixture of knowledge-based sarcasm detection with feature amalgamation to explore the various aspects of the text in order to recognize the correct type of the tweet. N-gram analysis techniques are used to extract tokens from the message data. Basically, for word-level tokenization is occurred. Mainly, the tokenization process relies on simple heuristics and is distinct from the whitespace characters (such as a space, line breaks) or by punctuation characters. These whitespace and punctuation can or cannot have comprised in the developing accrued record of tokens. On the other hand, there are many cases like hyphenated words, contractions, emoticons, and larger constructs such as URIs. The sarcasm detection technique is quite based upon the tweet category database that uses the n-gram analysis for message data. This model is designed in various components and each component has its own working and design. The new model contains different modules such as tokenization, feature extraction, classification density estimator, stop word filter, etc. Each components have created the final model of proposed work based on the sarcasm detection using feature engineering (or amalgamation) using various aspects of the text data.

3.2.2 **Tokenization**

It is the method to extract the keyword data from the input message string. It also enables the automatic sarcasm detection algorithms to find the category of the input tweet data, which gives better results within the lower time and small dictionary as compared to the complete phase dictionary. The proposed model has been analyzed under the N-gram model, which is capable of extracting the word combinations with the higher influence rather than extracting the stag words of less influence.

Algorithm 1: The tokenization method design

1. Acquire the string from the message body
2. Split the string into the word list
3. Count the number of words in the splitted string
4. Load the STOPWORD data

5. Start the iteration for each word (index)
 - a. Check the word (index) against the STOPWORD list
 - b. If the word (index) match return true
 - i. Filter the word out of the list
 - c. Otherwise, match the word (index) with the supervised data provided for the tokenization
 - d. If the token matches the data in the supervised lists
 - i. Add to the output token list
 - e. Check the token relation with the next word against the phrase data
 - f. If relation found
 - i. Pair both of the words word (index) and word (index + 1)
 - g. Otherwise, return the singular word (index)
 - h. If it's the last word
 - i. Return the word list
 - i. Otherwise GOTO 5(a)

Feature 1 Contrasting features: The first feature is entirely based upon the contrasting connotations, which is the most prominent factor showing the sarcastic expressions. The use of the contrasting combinations of emotion or meaning based words and phrases are mainly used to show sarcasm in the sentences. The example of the sarcastic expressions such as “I love being robbed during holidays,” or “I enjoying being cheated by businesses” are the high sarcasm phrases, which are used to show the most common form of sarcastic sentences. From these combinations, two primary things are cleared, which involves the affection and sentiment scores. The sentiment score is calculated by using the following algorithm, which is a kind of supervised sentiment analysis method.

Algorithm 2: Typical Sentiment analysis model

1. Perform the data acquisition
2. Perform user list extraction over the input data acquired from the social thread
3. Perform the message level extraction from the input data
4. Apply the supervised tokenization with the localized dictionary to extract each message M out of the total messages N

$$M = f \times (N, 'extract')$$

5. Apply the STOPWORD filtering over the message data denoted by M

$$tokens = \int Remove (M == stopWord)$$

6. Apply the polarization method over the filtered message in step 5

$$polarity = \int Score (M == polarWord)$$

7. Return the polarization value to the decision maker method under the proposed sentiment analysis algorithm

$$weight = \sum polarity$$

8. Classify the message polarity according to the computed weight
 - a. If the computed weight is lesser than 0
 - i. mark the message as negative
 - b. If the weight is higher than 0
 - i. mark the message as positive
 - c. If weight equals zero
 - i. mark message as neutral

To calculate the sentiment score, the dictionary-based sentiment analysis algorithm has been used over the tweet data, where each individual tweet is analyzed under the lexical chain method. The tri-option analysis, which includes the negative, neutral, and positive sentiments in the given tweets, where the negative score range is between -1 and -5 usually, whereas the positive tweet is noticed between 1 and 6 on a majority. The tweets with sentiment score of zero are considered neutral. The following methods are utilized to determine the affection and sentiment weightage of the individual terms and in the cumulative form.

$$A = \{affect(w)|w \in t\} \quad (3.1)$$

$$S = \{sentiment(w)|w \in t\} \quad (3.2)$$

$$\Delta affect = \max(A) - \min(A) \quad (3.3)$$

$$\Delta sentiment = \max(S) - \min(S) \quad (3.4)$$

Here, t denotes text contained in the tweet, whereas the w represents the words in the tweets. The $affect()$ is the function, which accepts the input of each word one by one and returns the matching affection in the form of affection weight, also known as special sentiment weight. The sentiment is computed by using the $sentiment()$ function, which works similarly as the $affect()$. The difference or contrast of the affection or sentiment is denoted with the symbols of $\Delta affect$ and $\Delta sentiment$. The minimum affection score is subtracted from the maximum affection and a similar step is performed for the sentiment score vector. The contrasting weight is returned to the program.

Feature 2 Affection analyses: The tweet data evaluation algorithm based upon the vital combination of above techniques such as sentiment analysis, tokenization, affection, etc. The new model is designed to collect data directly from online source or offline data source. The following algorithm explains the design of the affection model for the proposed model:

Algorithm 3: Affection analysis method

1. Acquire the dataset and chooses the raw data form of the read CSV file
2. Count number of rows in raw data,
3. Load STOPWORD list
4. Run the iteration for each message in the raw data
 - a. Extract the current message in the raw data
 - b. Filter the STOPWORDS from the input message data
 - c. Extract the tokens from the input messages data
 - d. Evaluate the affection score of the overall message
 - e. Return the message score to determine the degree of affection
 - f. Add to the detected polarity list of positive, negative or neutral
 - g. If the message is negative
 - i. Acquire the deep emotion supervised lists
 - ii. Determine the message under anger module
 - iii. Determine the message under disgust module
 - h. Return the deep sentiment results

Feature 3 Punctuation: This feature is the detailed feature, which counts for the various terms and their individual weights in order to understand the composition of the sentences in the given tweets. This is considered very important, as there is always a unique pattern behind each and every kind of phrase or sentence being written. The composition includes the various terms together such as special characters, punctuations, verbs, adverbs, etc. The following algorithm is used to determine this feature in an elaborative way:

Algorithm 4: Sentence composition extraction model

1. Acquire the tweet data obtained from the API
2. Count the rows in the tweet data matrix
3. Iterate for every row in tweet data matrix
 - a. Read the current tweet from the tweet data matrix
 - b. Convert the tweet string to lowercase
 - c. Normalize the string to make it process able through NLP processors
 - d. Replace the URL with the word “url”
 - e. Replace the string “@username” with the word “at_user”
 - f. Remove the hashtags from the string
 - g. Remove the number values from the input string
 - h. Remove the special characters from the input string
 - i. Convert the string to Unicode string
 - j. Apply the tokenization on the string
 - k. Replace the internet slangs with the original syntactic replacements in the tokens array
 - l. Convert the tokens to the string
 - m. Reapply the tokenization on the re-prepared string
 - n. Remove the stopwords from the extracted keywords under N-gram analysis

- o. Extract the subjective words
 - p. Add the output to the processed array
4. Acquire the training data
5. Process the training data
6. Apply the classification and Return the classification results
7. Compute the classification performance
8. Return the performance parameters.

3.3 Main News Classification Algorithm

Automatic sarcasm detection module is majorly defined to compute the density of the keywords related to the categories defined in the training model. The sarcasm detection algorithm is used to return the sentences from the message weight in the numerical form. The supervised classifier is trained with real tweets for the extraction of ontology with the goal that it will find hidden dependencies and also use them for predictions. For classification, supervised learning model and statistical method both are represented by Bayesian classification and also expect a probabilistic model which is used to grab uncertainty about the model by certain probabilities of the outcomes. It can figure out problems of diagnostic and predictive (Fig. 2).

4 Results

The proposed model has been designed for the sarcasm classification using the text analytical methods over the Twitter dataset. This data contains the various parameters, which includes various features such as affection, sentiment and punctuation related features, syntactic features, pattern related features, etc. In this work, the SVM, Maximum Entropy, KNN, and Random Forest classifiers are applied to the dataset in order to obtain the results.

Afterward, the data is divided into training and testing dataset, which is done using random selection by creating the random number series. The cross-validation split works on the different ratios, such as 10, 20, 30, 40, and 50% for cross-validation, which divided the testing samples accordingly into random groups of training and testing signatures under the prepared sub-datasets.

4.1 Performance Parameters

The performance evaluation of the proposed model is evaluated using the following parameters:

Fig. 2 Generalized supervised classification model for sarcasm detection

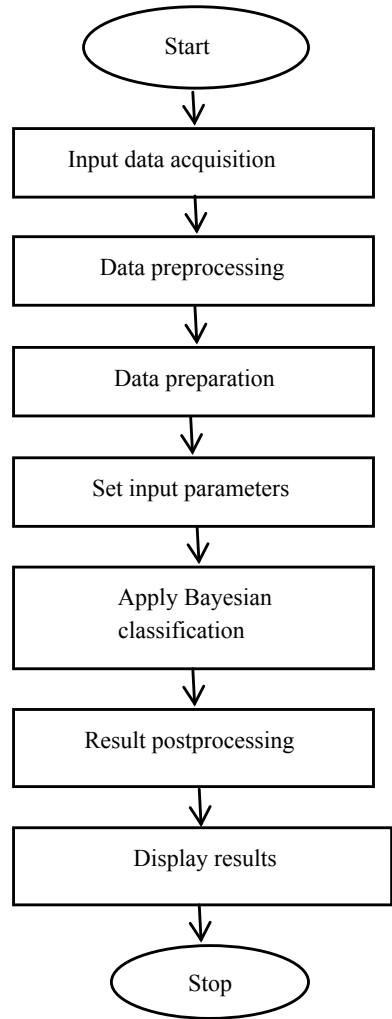

4.1.1 Accuracy

The overall accuracy is the analysis of the proposed model in the terms of overall accuracy, which is computed by dividing the total number of true cases (including true negative and true positive), by all of the cases.

$$Accuracy := \frac{True\ Positive + True\ Negative}{True\ Positive + True\ Negative + False\ Positive + False\ Negative} \quad (4.1)$$

4.1.2 Recall

Recall is the test of the probability of the accuracy, which indicates the performance of the proposed model in the presence of the false negative cases. The false negative cases depict the falsely detected case from the data entries. In recall, the accuracy of the proposed model has been analyzed in the presence of false negative cases:

$$Recall := \frac{True\ Positive}{True\ Positive + False\ Negative} \quad (4.2)$$

4.1.3 Precision

The precision depicts the accuracy of the model in the presence of false positive cases. The accuracy of the model depicts the overall impact of the false positive cases, which rejects positive cases. A positive case in our case is when the data entry contains a certain set of parameters from one of the registered category but returns the false result for such entries.

$$Precision := \frac{True\ Positive}{True\ Positive + False\ Positive} \quad (4.3)$$

4.1.4 F1-Measure

The F1-Measure is the cumulative parameter to assess the overall impact of the precision and recall in the case to study the overall impact of the false positive and false negative cases over the overall accuracy assessed from the preliminary statistical parameters. The F1-score value is represented in the range of 0 to 1 or 0 to 100, decided as per the maximum ranges of the precision and recall. The following equation is utilized to measure the F1-measure.

$$F1-Measure := 2 * \frac{(R * p)}{R + P} \quad (4.4)$$

where R is recall, and p or P is precision.

4.1.5 True Positive

The true positive reading is observed when the target tweet belongs to the sarcastic category and classification result also indicates similar after evaluating the tweet text.

4.1.6 True Negative

The true negative reading is observed when the target tweet is not sarcastic and the classification also confirms its non-sarcastic nature.

4.1.7 False Positive

The true negative reading is observed when the target tweet is not sarcastic, but the classification shows it as sarcastic tweet.

4.1.8 False Negative

The true positive reading is observed when the target tweet belongs to the sarcastic category, but the classification result indicates it as non-sarcastic after evaluating the tweet text.

4.2 Confusion Matrix

Error matrix is another term for confusion matrix and represents a unique table layout which confesses mental image of the execution of classifiers, mostly supervised learning classification. Confusion matrix is a primary kind of contingency table, having two dimensions, i.e., “actual” and “predicted” and in both dimensions sets of classes are same. Normally, positive are those which are identified and negative which are rejected. Therefore, after classification true positive are those which are correctly identified, false positive are describe incorrectly and also represent type 1 error in which no. of samples are incorrectly marked as positive. On the other hand, true negative are those which are correctly rejected, false negative represents incorrectly rejected data and also represent type 2 error in which no. of samples are marked incorrectly negative (Table 1).

Table 1 Confusion matrix

	True condition	
Predicted condition	True positive	False positive (type 1 error)
	False negative (type 2 error)	True negative

4.3 Four Different Classifiers for the Classification

- SVM (Support Vector Machine)
- MaxEnt (Maximum Entropy)
- KNN (K Nearest Neighbor)
- Random Forest

4.3.1 SVM

The method which is used for classification and regression is known as SVM, in which data is examined and patterns are identified. It is also used for outlier detection. This technique uses the concept of decision planes which define boundaries for decision. Basically, it is classification method in which hyperplane is constructed in multidimensional space to perform classification tasks which classify data into different label classes. The main task of SVM is to identify the right hyperplane to segregate classes. One of the most important techniques of SVM is kernels which transform low dimensional input space into higher dimensional input space and a kernel function that converts not separable problem to separable problem. SVM performs well when margin of separation is clear and also effective in high dimensional spaces.

4.3.2 Maximum Entropy

This classifier is commonly used in speech and information retrieval problems in NLP. Moreover, MaxEnt does not make assumption in considering the features, conditionally independent of each other, unlike the naïve Bayes. It is based on the application of maximum entropy from all the models that fits the training data. To solve a big number of text classification problems like sentiment analysis, topic classification etcetera, and this classifier can be applied. In terms of estimating the parameters of model, it is required to resolve the optimization problem and due to which mainly it takes more time to train as compared to naïve Bayes. However, in terms of CPU and memory consumption, it is quite competitive as it provides tough results while computing the parameters mentioned earlier.

4.3.3 KNN

Among all machine learning algorithms, k-nearest neighbor is the smallest one with the maximum vote of its neighbors, an object is classified. It is typically small, positive integer. The assignment of the object is simply done to the category of its closest neighbor if $k = 1$. Choosing k to an odd number is helpful in binary classification problem as tied votes are avoided by it.

The method which is used for KNN can be applied to regression by taking the average value of KNN to be the property value for the object. All the training samples are stored in instance based or lazy learners, which are nearest neighbor classifiers and a new sample is required to be categorized without which it cannot build a classifier. Also, for making projections it can be used.

4.3.4 Random Forest

This [10] was the first paper which brought the concept of ensemble of decision trees which is known random forest, which is composed by combining multiple decision trees. While dealing with the single tree classifier there may be the problem of noise or outliers which may possibly affect the result of the overall classification method, whereas random forest is a type of classifier which is very much robust to noise and outliers because of randomness it provides. Random forest classifier provides two types of randomness, first is with respect to data and second is with respect to features. Random forest classifier uses the concept of bagging and bootstrapping.

4.4 Result Evaluation

The results of the proposed model are analyzed for the different classifiers, which includes SVM, maximum entropy, KNN, and random forest algorithms to calculate the sarcastic sentiment in the given set of tweets. The proposed model is cross-validated using the different split ratios, which ranges between 10 and 50%. The results of the simulated are collected in the form of type 1 and 2 errors and statistical accuracy based parameters to calculate overall achievement of work. Table 2 shows statistical accuracy based parameters for the split ratio of 10% with different classification algorithms:

Table 2 Result analysis of 10% split ratio with statistical accuracy based parameters

Classification algorithms	Precision (%)	Recall (%)	Accuracy (%)	F1-measure (%)
SVM	84.4	77.2	78.6	80.7
MaxEnt	81.0	82.0	80.5	81.5
KNN	77.9	73.1	73.1	75.4
Random forest	78.5	92.3	85.1	84.8

Table 3 Confusion matrix for SVM classifier of 10% split ratio

	True condition	
Predicted condition	272	50
	80	206

Table 4 Confusion matrix for maximum entropy classifier of 10% split ratio

	True condition	
Predicted condition	261	61
	57	229

Table 5 Confusion matrix for KNN classifier of 10% split ratio

	True condition	
Predicted condition	251	71
	92	194

Table 6 Confusion matrix for random forest classifier of 10% split ratio

	True condition	
Predicted condition	253	69
	21	265

The accuracy based analysis shows the dominance of random forest classifier among all other classification options. The random forest-based model is observed with 92.3% recall, 85.2% overall accuracy and 84.9% f1-error, which are highest among the other options, whereas the 84.4% precision is observed for SVM as highest value, in comparison with random forest (78.5%), which is only exception.

Tables 3, 4, 5, and 6 show the results obtained from the first experiment, which has been conducted with 10% testing data based cross validation. Out of all of the four models, the highest true negative (265) and lowest false negative (21) cases are observed for random forest. On the other hand, the lowest false positives (50) and highest true positives (272) are observed for SVM. Table 2 produces the further accuracy based results on the testing data.

The following line graphs contain two axis, i.e., x-axis and y-axis. In x-axis, there are four different supervised algorithms that are used to classify the data and in y-axis contain a range of data in percentage for precision, recall, accuracy, and f1-measure.

The above Figs. 3 and 4 show the graphical results of the above Table 2. The dominance of random forest based classification can be clearly noticed in the above figure, which is observed higher than others in recall, overall accuracy, and f1-measure based parameters. The random forest classifier is observed best on the basis of recall, accuracy, and f1-measure parameters, whereas for the precision support vector machine classifier is observed the best among all options.

The accuracy based analysis shows the dominance of random forest, where maximum recall (93.2%), overall accuracy (84.9%), and f1-measure (85.4%) are observed, which is significantly higher than other classifiers. In contrast, the SVM classifier

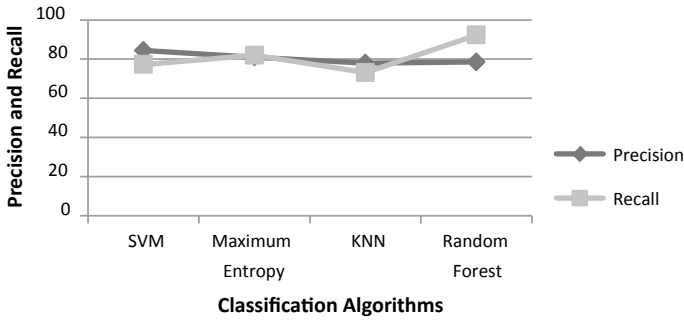

Fig. 3 Result analysis of 10% split ratio with precision and recall based parameters

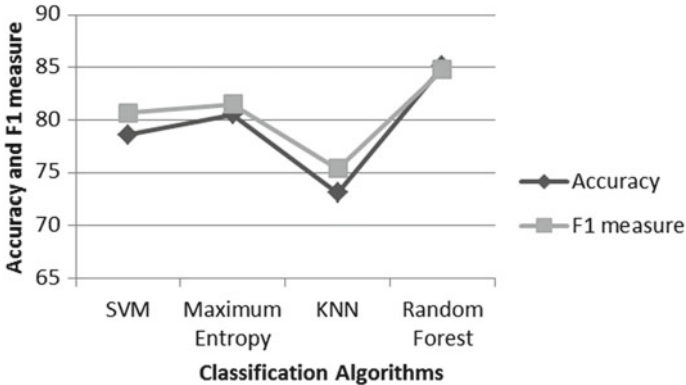

Fig. 4 Result analysis of 10% split ratio with accuracy and F1-measure based parameters

Table 7 Result analysis of 20% split ratio with statistical accuracy based parameters

Classification algorithms	Precision (%)	Recall (%)	Accuracy (%)	F1-measure (%)
SVM	83.9	79.1	78.6	81.4
MaxEnt	83.0	85.4	82.6	84.2
KNN	76.1	76.3	73.4	76.2
Random forest	78.7	93.2	84.9	85.3

is observed with 83.9% precision is observed in comparison with random forest (78.8%).

The results of 20% testing ratio based cross-validation is evaluated with all classifiers in another experiment. The highest true negatives (497) and minimum false negatives (39) are observed for random forest among all classifiers. The lowest false positives (109) and the highest true positives (570) are observed for the SVM classifier. The overall accuracy based evaluation is shown in Table 7.

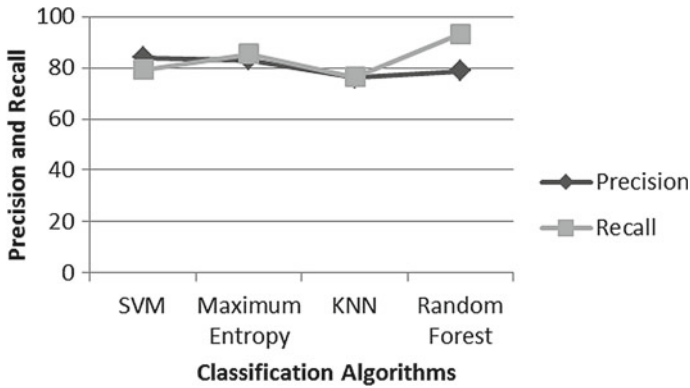

Fig. 5 Result analysis of 20% split ratio with precision and recall based parameters

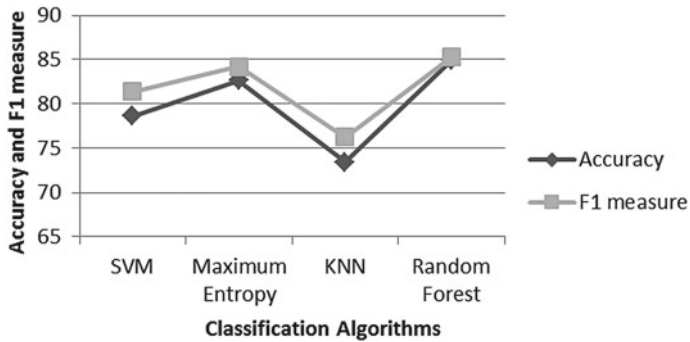

Fig. 6 Result analysis of 20% split ratio with accuracy and F1-measure based parameters

Table 8 Confusion matrix for SVM classifier of 20% split ratio

	True condition	
Predicted condition	570	109
	150	386

Table 9 Confusion matrix for Maximum Entropy classifier of 20% split ratio

	True condition	
Predicted condition	564	115
	96	440

In the Figs. 5 and 6 similar to previous figure, random forest classifier is observed with highest recall (>93%), highest accuracy (approx. 84%), and highest f1-measure (>85%), which supports the selection of random forest as best classifier in comparison with other SVM, KNN, and MaxEnt for the sarcasm classification in Twitter data (Tables 8, 9, 10, 11, and 12).

Table 10 Confusion matrix for KNN classifier of 20% split ratio

	True condition	
Predicted condition	517	162
	160	376

Table 11 Confusion matrix for Random Forest classifier of 20% split ratio

	True condition	
Predicted condition	535	144
	39	497

Table 12 Result analysis of 30% split ratio with statistical accuracy based parameters

Classification algorithms	Precision (%)	Recall (%)	Accuracy (%)	F1-measure (%)
SVM	83.9	78.7	78.7	81.2
MaxEnt	81.9	85.7	82.6	83.7
KNN	75	74.2	72.0	74.6
Random forest	78.6	93.4	85.2	85.3

Table 13 Confusion matrix for SVM classifier of 30% split ratio

	True condition	
Predicted condition	839	161
	226	597

The accuracy based analysis of the classifiers on cross-validation with 30% testing data again shows the dominance of random forest classifier, with only exception of the highest precision in case of SVM. The random forest classifier based model is observed with highest recall (93.4%), overall accuracy (85.2%), and f1-measure (85.3%) in comparison with second highest recall (85.7%), accuracy (82.6%), and f1-measure (83.7%) in case of MAXENT classifier (Tables 13, 14, and 15).

Table 14 Confusion matrix for Maximum Entropy classifier of 30% split ratio

	True condition	
Predicted condition	819	181
	136	687

Table 15 Confusion matrix for KNN classifier of 30% split ratio

	True condition	
Predicted condition	750	250
	260	563

Table 16 Confusion matrix for Random Forest classifier of 30% split ratio

Predicted condition	True condition	
	786	214
55	768	

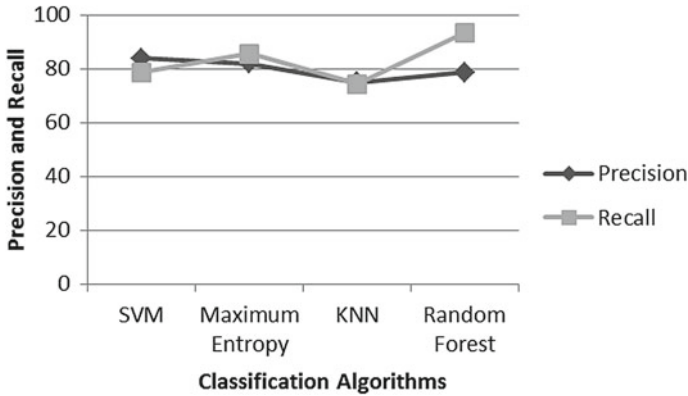

Fig. 7 Result analysis of 30% split ratio with precision and recall based parameters

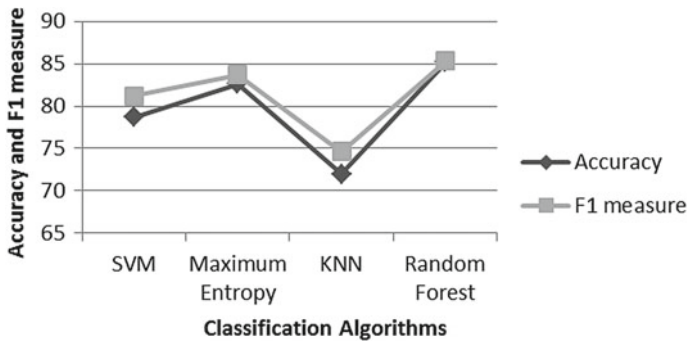

Fig. 8 Result analysis of 30% split ratio with accuracy and F1-measure based parameters

Similarly, as observed from the Table 16, the random forest classifier is also observed with highest true negatives and lowest false negatives, whereas SVM dominates the lowest false positives and highest true positives as per the result synthesis of Table 15.

In the above Figs. 7 and 8, the proposed model based upon random forest is observed with highest recall value (>93%), accuracy (>85%), and f1-measure (>85%), which proves its best performance among other classification methods, whereas the value of recall, accuracy and f1-measure are observed for KNN (74.2, 72.0, and 74.6%), MAXENT (85.7, 82.6, and 83.7%), and SVM (78.7, 78.7, and 81.2%). On the contrary, SVM has been observed with significantly higher on the

Table 17 Result analysis of 40% split ratio with statistical accuracy based parameters

Classification algorithms	Precision (%)	Recall (%)	Accuracy (%)	F1-measure (%)
SVM	84.3	76.7	77.6	80.3
MaxEnt	83.0	84.7	82.7	83.9
KNN	75.2	72.9	71.4	74.0
Random forest	79.1	92.1	85.0	85.1

Table 18 Confusion matrix for SVM classifier of 40% split ratio

	True condition	
Predicted condition	1109	206
	336	779

Table 19 Confusion matrix for maximum Entropy classifier of 40% split ratio

	True condition	
Predicted condition	1092	223
	196	919

Table 20 Confusion matrix for KNN classifier of 40% split ratio

	True condition	
Predicted condition	989	326
	367	748

basis of precision (approx. 84%), which is outperformed by the overall accuracy in random forest (85%) in comparison with SVM’s 78.7% (Table 17).

The accuracy based analysis shows the dominance of random forest, where maximum recall (92.1%), overall accuracy (85.0%), and f1-measure (85.1%) are observed, which is significantly higher than other classifiers. In contrast, the SVM classifier is observed with 85.3% precision is observed in comparison with random forest (79.1%).

The results of the simulated are collected in the form of type 1 and 2 errors and statistical accuracy based parameters to calculate the overall achievement of work. Above tables (Tables 18, 19, 20 and 21) show the results of type 1 and type 2 errors and statistical accuracy based parameters for the split ratio of 40% with different classification algorithms. The random forest dominates for true negatives and false negatives, whereas SVM dominates for false positives and true positives, which is similar to the previous result analysis of type 1 and 2 errors.

Table 21 Confusion matrix for random forest classifier of 40% split ratio

	True condition	
Predicted condition	1041	274
	89	1026

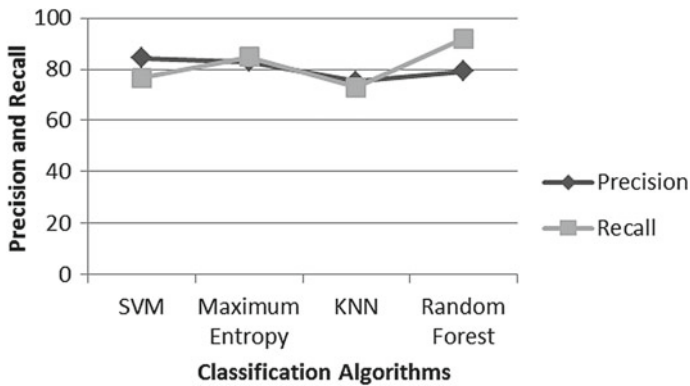

Fig. 9 Result analysis of 40% split ratio with precision and recall based parameters

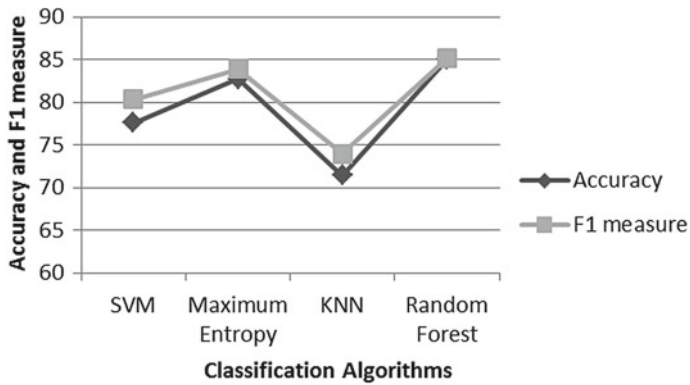

Fig. 10 Result analysis of 40% split ratio with accuracy and F1-measure based parameters

Table 22 Result analysis of 50% split ratio with statistical accuracy based parameters

Classification algorithms	Precision (%)	Recall (%)	Accuracy (%)	F1-measure (%)
SVM	85.2	75.4	77.1	80.0
MaxEnt	83.3	84.7	82.9	84.0
KNN	74.3	72.9	71.3	73.6
Random forest	80.0	91.9	85.4	85.5

The above Figs. 9 and 10 show the graphical results of the above Table 17. The dominance of random forest-based classification can be clearly noticed the above figure, which is observed higher than others in recall, overall accuracy, and f1-measure based parameters (Table 22).

Table 23 Confusion matrix for SVM classifier of 50% split ratio

	True condition	
Predicted condition	1394	242
	453	948

Table 24 Confusion matrix for maximum entropy classifier of 50% split ratio

	True condition	
Predicted condition	1363	273
	246	1155

Table 25 Confusion matrix for KNN classifier of 50% split ratio

	True condition	
Predicted condition	1216	420
	451	950

Table 26 Confusion matrix for random forest classifier of 50% split ratio

	True condition	
Predicted condition	786	214
	55	768

The accuracy based analysis of the classifiers on cross-validation with 50% testing data again shows the dominance of random forest classifier, with only exception of highest precision in case of support vector machine. The random forest classifier based model is observed with highest recall (91.1%), overall accuracy (85.4%), and f1-measure (85.5%) in comparison with second highest recall (84.7%), accuracy (82.9%), and f1-measure (84.0) in case of MaxEnt classifier (Tables 23, 24, and 25).

In the case of Table 26, the highest true negatives (1286) and lowest false negatives (115) are observed for random forest, whereas the highest true positives (1394) and lowest false positives (242) for support vector machine. The overall result is worst in the case of KNN and best in the case of random forest on the basis of observations in Table 26. Table 22 describes the results of 50% cross-validation obtained in the form of statistical accuracy based parameters.

In Figs. 11 and 12, the accuracy based analysis shows the dominance of random forest, where maximum recall (91.9%), overall accuracy (85.4%), and f1-measure (85.5%) are observed, which is significantly higher than other classifiers. In contrast, the SVM classifier is observed with 85.2% precision is observed in comparison with random forest (80.0%).

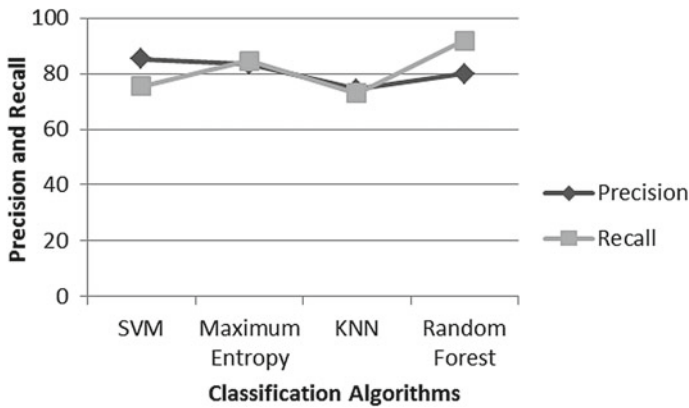

Fig. 11 Result analysis of 50% split ratio with precision and recall based parameters

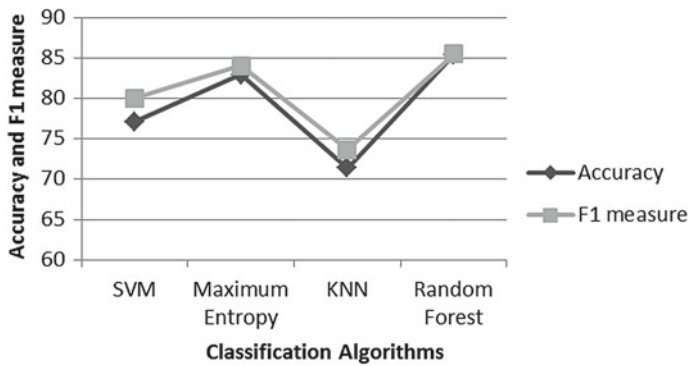

Fig. 12 Result analysis of 50% split ratio with accuracy and F1-measure based parameters

5 Conclusion and Future Scope

The proposed model has been designed for evaluation of the tweet data on the various categories, which involves the tweet data obtained from Twitter containing the several tweets including non-sarcastic and sarcastic tweets using the unique combination of the feature descriptors, which primarily includes the contrasting sentiment this feature is entirely based upon the contrasting connotations, which is the most prominent factor showing the sarcastic expressions, the second feature is affection analysis, i.e., used for the evaluation algorithm based upon the vital combination of above techniques such as sentiment analysis, tokenization, affection, etc., and third feature is punctuation the detailed feature, which counts for the various terms and their individual weights in order to understand the composition of the sentences in the given tweets. The proposed model based upon the supervised classification based upon random forest has been observed the best among the test classification

algorithms, where the random forest is observed with (84.7%) of overall accuracy in comparison with other supervised classification models of SVM (78.6%), logistic regression (80.5%), and KNN (73.1%).

In the future, the proposed model can be further improved by using the more advanced and/or compact feature set, which can provide the more specific information to the sarcastic expressions than the approach used in this paper. The application of feature selection based upon effective algorithms like particle swarm optimization (PSO), genetic algorithm (GA), etc. will be used to attain higher exactness for sarcasm detection.

References

1. <http://language.worldofcomputing.net/category/machine-translation>
2. S. Tanwar et al., Multimedia big data computing and internet of things applications: a taxonomy and process model. *J. Netw. Comput. Appl.* (2018)
3. E. Riloff, A. Qadir, P. Surve, L. De Silva, N. Gilbert, R. Huang, Sarcasm as contrast between a positive sentiment and negative situation, in *Proceedings of the Conference on Empirical Methods in Natural Language Processing (EMNLP)* (2013), pp. 704–714
4. M.A. Walker, J.E.F. Tree, P. Anand, R. Abbott, J. King, A corpus for research on deliberation and debate, in *LREC* (2012), pp. 812–817
5. E. Fersini, F.A. Pozzi, E. Messina, Detecting irony and sarcasm in microblogs: the role of expressive signals and ensemble classifiers, in *Proceedings of the IEEE Conference on Data Science and Advanced Analytics, IEEE* (2015), pp. 1–8
6. M. Bouazizi, T. Ohtsuki, A pattern-based approach for sarcasm detection on Twitter. *IEEE* **4**, 5477–5488 (2016)
7. S. Poria, E. Cambria, D. Hazarika, P. Viji, A deeper look into sarcastic tweets using deep convolutional neural networks (2016)
8. A. Joshi, S. Agrawal, P. Bhattacharyya, M. Carman, Expect the unexpected: harnessing sentence completion for sarcasm detection, in *Proceedings of the International Conference of the Pacific Association for Computational Linguistics* (Springer, Singapore, 2017), pp. 275–287
9. S.K. Bharti, R. Pradhan, K.S. Babu, S.K. Jena, Sarcastic sentiment detection based on types of sarcasm occurring in twitter data. *Int. J. Sem. Web Inf. Syst. (IJSWIS)* **13**, 89–108 (2017)
10. S.K. Bharti, K.S. Babu, S.K. Jena, Parsing-based sarcasm sentiment recognition in twitter data, in *Proceedings of the International Conference on Advances in Social Networks Analysis and Mining, IEEE/ACM* (2015), pp. 1373–1380
11. J. Kaur et al., Text analytical models for data collected from micro-blogging Portal—a review. *J. Emerg. Technol. Innov. Res. (JETIR)* **5**, 81–86 (2018)
12. M. Khodak, N. Saunshi, K. Vodrahali, A large self-annotated corpus for Sarcasm (2018)
13. S. Saha, J. Yadav, P. Ranjan, Proposed approach for sarcasm detection in Twitter. *Indian J. Sci. Technol.* **10** (2017)
14. P. Deshmukh, S. Solanke, Review paper: sarcasm detection and observing user behavioral. *Int. J. Comput. Appl.* **166** (2017)
15. V. Haripriya, P.G. Patil, A survey of sarcasm detection in social media. *Int. J. Res. Appl. Sci. Eng. Technol. (IJRASET)* (2017)
16. A. Joshi, P. Bhattacharya, M.J. Carman, Automatic sarcasm detection: a survey. *ACM Comput. Surv. (CSUR)* **50** (2017)
17. A.D. Dave, N.P. Desai, A comprehensive study of classification techniques for sarcasm detection on textual data, in *Proceedings of the International Conference on Electrical, Electronics and Optimization Techniques (ICEEOT)* (2016), pp. 1985–1991

18. W. Medhat, A. Hassan, H. Korashy, Sentiment analysis algorithms and applications: a survey. *Eng. J.* **5**, 1093–1113 (2014)
19. Tomas Ptacek, Ivan Habernal and Jun Hong, “Sarcasm detection on Czech and English twitter”, *Proceedings of the 25th International Conference on Computational Linguistics: Technical Papers, COLING*, pp. 213–223, 2014
20. D. Khurana, A. Koli, K. Khatter, S. Singh, *Natural language processing: state of the art, current trends and challenges* (2017)
21. E. Lunando, A. Purwarianti, Indonesian social media sentiment analysis with sarcasm detection, in *Proceedings of the International Conference on Advanced Computer Science and Information Systems (ICACSIS), IEEE* (2013), pp. 195–198
22. https://www.google.com/search?q=starting+window+of+spyder&tbm=isch&source=iu&ictx=1&fir=dJnEECXUMNvM%253A%252Cf1HkEljoqWS7zM%252C_&usg=__3Jdt9STOUxjMyHHYZ2UmfL697k%3D&sa=X&ved=0ahUKEwiUoo2zz_LaAhVKr48KHcmQDIkQ9QEIajAG#imgrc=dJnEEC-XUMNvM
23. [https://en.wikipedia.org/wiki/Spyder_\(software\)](https://en.wikipedia.org/wiki/Spyder_(software))
24. <https://wiki.python.org/moin/BeginnersGuide/Overview>
25. D. Dmitry, O. Tsur, A. Rappoport, Enhanced sentiment learning using Twitter hashtags and smileys, in *Proceedings of the 23rd International Conference on Computational Linguistics: posters* (2010), pp. 241–249
26. B. Ohana, B. Tierney, Sentiment classification of reviews using SentiWordNet (2009)
27. S.B. Kotsiantis, I. Zaharakis, P. Pintelas, Supervised machine learning: a review of classification techniques, in *Emerging Artificial Intelligence Applications in Computer Engineering* (2007)
28. A. Pak, P. Paroubek, Twitter as a corpus for sentiment analysis and opinion mining. *LREC* **10**, 1320–1326 (2010)

Part II
Multimedia Big Data Analytics

Peak-to-Average Power Ratio Reduction in FBMC Using SLM and PTS Techniques



Arun Kumar and Manisha Gupta

Abstract Orthogonal frequency division multiplexing (OFDM) is the advanced transmission scheme utilized in 4G. Nevertheless, it has several shortcomings like guard band, peak-to-average power ratio (PAPR), high power consumption, incapable to accommodate various other devices (an IOT application). Hence, OFDM cannot be considered in 5G due to the several disadvantages mentioned above. Filter bank multi-carrier (FBMC) is believed to be one of the most promising technologies which can be used in 5G. FBMC and OFDM are multi-carrier system. It is obvious that it agonizes from PAPR which hamper the efficiency of the system. The conventional peak reduction methods utilized in OFDM cannot be used in FBMC due to the overlapping structure of FBMC. In this work, a novel selective mapping (SLM) and partial transmit sequence (PTS) PAPR reduction technique is suggested for FBMC. The proposed techniques are implemented by using an elementary successive optimization technique that upsurge the PAPR performance and ensure the design difficulty is taken low. PAPR and bit error rate (BER) parameters are analyzed and simulated for the proposed and conventional PAPR reduction techniques. The simulation results show that the SLM and PTS accomplished an excellent PAPR reduction up to 2.8 and 4.8 dB as compared to other peak power minimization techniques.

Keywords FBMC · PAPR · SLM · PTS · Clipping

A. Kumar (✉)

Department of Electronics and Communication Engineering, JECRC University,
Jaipur 303905, India
e-mail: arun.kumar1986@live.com

M. Gupta

Department of Physics, University of Rajasthan, Jaipur 302004, India
e-mail: dr GuptaManisha@uniraj.ac.in

© Springer Nature Singapore Pte Ltd. 2020
S. Tanwar et al. (eds.), *Multimedia Big Data Computing for IoT Applications*, Intelligent Systems Reference Library 163,
https://doi.org/10.1007/978-981-13-8759-3_6

1 Background

In the year 1895, Marconi invented radio which was used to transmit the signal from one place to another place without the use of wires for which he got the noble prize in the year 1909. Graham Bell and Charles Sumner Trainers invented telephone in the year 1876 which was the beginning of telecommunication era. The first commercial phone was designed and implemented in Bell Lab, USA in 1876. Analog frequency transmission scheme and high-power transmitter were used in early mobile which limit the coverage up to 50 km due to which very few customers get the service with lots of constraint of spectrum. In order to achieve an efficient bandwidth, cellular model was introduced by Bell Lab which utilized the technique called frequency reuse to achieve an efficient bandwidth and power consumption was also reduced. The first-generation mobile phone also known as 1G was consisting of analog system accessing frequency division multiple access (FDMA) technique. Sensitive to interference, requirement of high power, and its analog technique were few disadvantages of 1G mobile. One of the main reasons for failure of analog mobile was usage of different standards by different countries which were incompatible. To overcome the issues of 1G, second-generation (2G) mobile were introduced which used digital technology. Better spectrum utilization due to accessing of advanced modulation technique, high capacity, introduction of SMS, improved handoff, and good signaling were few advantages of 2G. Among several, most popular 2G mobile phone was GSM (Global system for mobile communication). Due to rising demands from the industry and subscribers like high data rate lead to development of third-generation (3G) mobile communication system. In 3G, CDMA is used as a modulation technique, where multiple users share the same channel with different codes [1]. Hence, CDMA is considered as one of the secured communication. ISI, cross talk, and high power consumption are the disadvantages in CDMA due to which OFDM is considered in fourth-generation mobile communication system (4G). In the year 1971, Weinstein and Ebert introduced a new multi-carrier technique whose set of modulator and demodulator was replaced by using a discrete Fourier transform (DFT). OFDM as a radio technique is widely used for high data rate wireless communication system due to its better utilization of the spectrum and immune to fading of signals [2]. For instance, in OFDM, CP (Cyclic Prefix) is inserted between two symbols to eliminate inter-symbol interference (ISI). However, CP results in wastage of bandwidth. OFDM cannot be considered adequate for this purpose due to the abovementioned disadvantages. Hence, next-generation mobile communication is commonly known as 5G will need a new and improved technological core. A new modulation technique, such as FBMC, is being explored and experimented upon in hopes that one of them may become a conceivable option for 5G wireless communication.

1.1 Introduction

FBMC is the most probable modulation techniques that have been able to exhibit not similar but better performance than OFDM. It does not insert a CP between the symbols, meaning the availability of extra bandwidth. It is an advanced version of OFDM, which uses a set of filters at both the transmitter and receiving end to provide better communication with more prudent bandwidth utilization [3]. OFDM as a radio technique is widely applied for high data rate wireless communication system due to its better utilization of the spectrum and immune to fading of signals. Contrariwise, it has the shortcoming of PAPR and spectral transmission in the wireless environment. Combined with the multiple inputs and multiple outputs (MIMO), MIMO-OFDM plays a significant role in enhancing the capacity and data rate by reducing a multipath and co-channel interference. MIMO-OFDM includes a large number of antennas at the transmitter and receiver. Hence, it receives the signals from the transmitter through different paths. However, high power consumption and implementation cost are the major disadvantage of MIMO-OFDM [4]. High-speed data transfer networks are the primary requirement for technology enhanced digital world for improvement of services and hence the lives of a human being. To cater the need of large amount of data at higher speed for real-time applications, next-generation communication systems should be developed. The next-generation wireless networks known as fifth-generation mobile communication (5G) must be able to address the capacity constraints and the existing challenges associated with current communication systems such as network link reliability, coverage and latency, and energy efficiency. Nevertheless, the principle of OFDM and FBMC is the same as both are multi-carrier techniques [5]. In multi-carrier methods, the subsequent result is the assemblage of numerous subcarriers that leads to a situation where peak power increases in the system [6]. Hence, the operation of the amplifier utilized in FBMC and OFDM system gets reduced. The peak power reduction techniques utilized in OFDM cannot be considered in proposed FBMC due to their intersecting structure [7, 8]. Therefore, in that respect is a requirement to study PAPR minimization methods for FBMC arrangement [9, 10]. The work presents the implementation of a novel PTS and SLM peak power reduction techniques for FBMC system. BER, PAPR measurements were simulated and examined.

2 Conventional SLM

One of the disadvantages of SLM detection is long latency which occurs due to the serial processing of the signals [11–15]. In this work, SLM detection scheme is implemented with parallel processing that scales the latency and complexity. One of the constraint point of this proposed scheme is to detect M transmit signal under N stages. The proposed method finds rank of $X^{\wedge}(k)$ to determine channels order. The second step is to calculated rank $T^{\wedge}(k)$ after QR disintegration and QR rearrange-

Fig. 1 Proposed channel ranking from an $M \times T$ matrix [24]

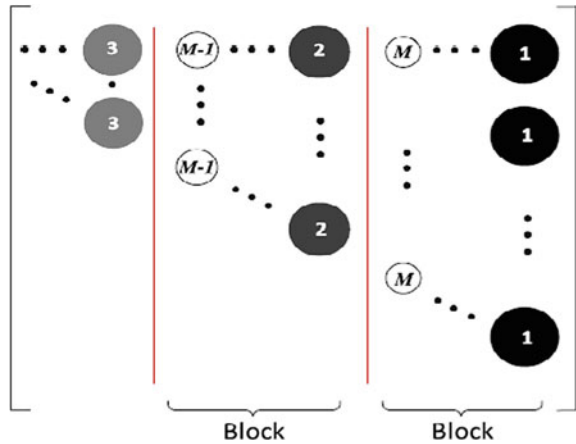

ment. The ranking method of channel is indicated by Fig. 1. The power rank of each column is given by the number of circles which are allocated likewise to all blocks [16–20]. The numbers of blocks are arranged in downward direction starting from the right-hand side. The circle of black, white, and gray indicates the comparative power. The power of black circle is greater than white and gray. In the next step, the triangular matrix $T^{\wedge}(k)$ is converted into staircase matrix. This is achieved by eliminating the $T^{\wedge}(k)$ by using Gauss-Jordan elimination method [21–23]. The parallel detection determines the step of staircase matrix. In the other word, staircase matrix step depends on the number of blocks: For example, when four and two blocks are used then $T^{\wedge}(k)$ is given in Figs. 2 and 3 which are independent of each other. In this case, A_n is the nth block.

By utilizing $T^{\wedge}(k)$, the parallel detection is achieved to detect the transmitted signal. The RGB circles are initially detected simultaneously. Hence, the latency of the suggested method is decreased by $1/N_a$ times as comparing to conventional SLM method. Second, the diversity rate of the proposed technique is also decreased by the same order. Hence, the latency and diversity are independent of each other. The gain

Fig. 2 Modified T matrix as a four block T^{\wedge} [21]

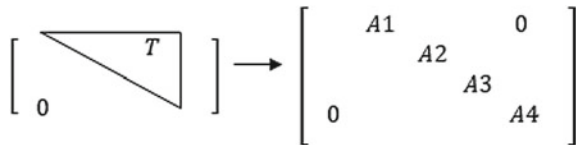
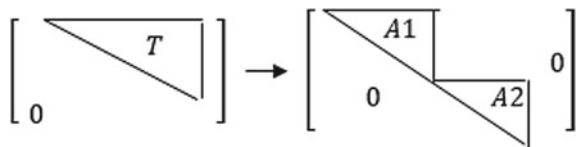

Fig. 3 Modified T matrix as a two block T^{\wedge} [25]



of the system can be enhanced slightly by increasing the diversity order. Therefore, it is not desirable to select extreme diversity order. Hence, in this proposed method, its diversity order is taken as four to obtain the optimum latency [26]. For example, we select two blocks in 4×4 MIMO. The rank of $T^\wedge(k)$ is given as

$$\begin{bmatrix} T_{1,\text{rank}(4)}(k)T_{1,\text{rank}(1)}(k)T_{1,\text{rank}(3)}(k)T_{1,\text{rank}(2)}(k) \\ T_{2,\text{rank}(4)}(k)T_{2,\text{rank}(1)}(k)T_{2,\text{rank}(3)}(k)T_{2,\text{rank}(2)}(k) \\ T_{3,\text{rank}(4)}(k)T_{3,\text{rank}(1)}(k)T_{3,\text{rank}(3)}(k)T_{3,\text{rank}(2)}(k) \\ T_{4,\text{rank}(4)}(k)T_{4,\text{rank}(1)}(k)T_{4,\text{rank}(3)}(k)T_{4,\text{rank}(2)}(k) \end{bmatrix} \quad (1)$$

Therefore, $Y(k)$ is given as

$$\begin{bmatrix} Y_4(K) \\ Y_1(K) \\ Y_2(K) \\ Y_3(K) \end{bmatrix} = \begin{bmatrix} T_{11}(k) & T_{12}(k) & T_{13}(k) & T_{14}(k) \\ 0 & T_{22}(k) & T_{23}(k) & T_{24}(k) \\ 0 & 0 & T_{33}(k) & T_{34}(k) \\ 0 & 0 & 0 & T_{44}(k) \end{bmatrix} \begin{bmatrix} X_4(K) \\ X_1(K) \\ X_2(K) \\ X_3(K) \end{bmatrix} \quad (2)$$

Hence, $T_{13}(k)$ and $T_{23}(k)$ are eradicated we select the third row. After $T_{14}(k)$ and $T_{24}(k)$ are eradicated by the fourth row $Y^\wedge(k)$ is given as

$$\begin{bmatrix} Y_4^\wedge(K) \\ Y_1^\wedge(K) \\ Y_2^\wedge(K) \\ Y_3^\wedge(K) \end{bmatrix} = \begin{bmatrix} T_{11}(k) & T_{12}(k) & 0 & 0 \\ 0 & T_{22}(k) & 0 & 0 \\ 0 & 0 & T_{33}(k) & T_{34}(k) \\ 0 & 0 & 0 & T_{44}(k) \end{bmatrix} \begin{bmatrix} X_4(K) \\ X_1(K) \\ X_2(K) \\ X_3(K) \end{bmatrix} \quad (3)$$

where $V^\wedge(k)$ is the permuted $Y(k)$.

Hence, by using Eq. (3) the detection of $X_4(K)$, $X_1(K)$, $X_2(K)$ and $X_3(K)$ are independently functioned as

$$\begin{bmatrix} Y_4^\wedge(K) \\ Y_1^\wedge(K) \end{bmatrix} = \begin{bmatrix} T_{11}(k) & T_{12}(k) \\ 0 & T_{22}(k) \end{bmatrix} \begin{bmatrix} X_4(K) \\ X_1(K) \end{bmatrix} \quad (4)$$

$$\begin{bmatrix} Y_3^\wedge(K) \\ Y_2^\wedge(K) \end{bmatrix} = \begin{bmatrix} T_{33}(k) & T_{34}(k) \\ 0 & T_{44}(k) \end{bmatrix} \begin{bmatrix} X_2(K) \\ X_3(K) \end{bmatrix} \quad (5)$$

Hence, the signal $X_4(K)$, $X_1(K)$, $X_2(K)$, and $X_3(K)$ are detected simultaneously in two step, and in this way the latency and multiplication complexity of the projected scheme is drastically decrease [27, 28]. The past and present studies are given in Table 1.

Table 1 PAPR reduction techniques with outcomes

References	Technique	System model	PAPR (%)
[29]	PTS	OFDM	4.1
[30]	STR and TI	OFDM	6
[31]	Hybrid clipping	OFDM	8, 4
[32]	Circular fourier transformation	4-QAM WPT-OFDM, FFT-OFDM	7.05 and 4.95
[33]	Chiken swarm optimization	Coherent Optical-OFDM	5.5
[34]	Hybrid and filtering	QPSK-OFDM	6.3 and 7.3
[35]	Double hybrid, A. hybrid	OFDM	6.569, 5.8 and 5.3
[36]	I.Noise, clipping, and μ Law	OFDM	3.8, 6.6 and 10.2
[37]	Improved SLM for PAPR reduction	OFDM	2.6
[38]	Hybrid, M-Hybrid	FBMC	6 and 7
[39]	DCT-Precoding, WHT-Precoding, and MU-Law commanding	FBMC	3.5 and 13.4
[40]	ACE, TRACE, and TR reduction method	FBMC	4, 4.2 and 7
[41]	Clipping and filtering	FBMC	7 and 6.3
[42]	TSLM and MBJO-PTS	FBMC	8.2 and 7.4
[43]	SLM and W-SLM	FBMC	8 and 7.5
[44]	Tone injection, companding	FBMC	10.5 and 3.7

3 Single Carrier Versus Multi-carrier Modulation

In single carrier systems, a guard band must be placed between each carrier bandwidth to provide a space where an adjacent carrier signal can be attenuated to prevent data loss. But this is wastage of costly bandwidth only. Also, in a multipath propagation environment, a shorter symbol period drives toward greater possibility ISI. The OFDM, a multi-carrier system, is well capable of addressing these problems of a single carrier system. Available channel is divided into several narrowband sub-channels which experience almost flat-fading making equalization very simple. Orthogonality of subcarriers allows them to overlap each other without interference which results in saving of bandwidth which is a constraint for wireless communication. Also, symbols acquiring long symbol duration undergo serial to parallel conversion which eliminates the ISI and increases the data rates significantly. Disadvantage of the single carrier system is when we increase the number of users than the overall quality of service decrease. Inter-symbol interference and huge power

consumption create a big problem in single carrier system. For a high-frequency communication, multi-carrier modulation techniques are more efficient [45].

3.1 Orthogonal Frequency Division Multiplexing (OFDM)

OFDM has been recently proposed in many advanced techniques. Also, several precise methods of OFDM have been suggested for cognitive radio (Cr) systems [46, 47]. A subsection of subcarriers is allotted to each and every user. To overcome inter-carrier interference (ICI), synchronization between the subcarriers signals need to be achieved at the receiver input. Bearing on this point, OFDM fits in downlink, where OFDM signals are transmitted from the identical terminal. Hence, synchronization can be easily carried out the equivalent Doppler frequency change at each receiver. On the other hand, in the uplink of an OFDM system, synchronization between subcarrier signals is difficult to attain. Further, digital algorithm steps have to be added to reduce interference among the subcarrier from diverse ends. Additional digital algorithm steps increase the complexity in OFDM receiver [48]. The problem is increasing in Cr system where both license and non-license users communicate autonomously and might be centered on different rules. This problem can be overcome by using a filtering technique that separates the license and non-license user signals. OFDM with filters introduce large side lobes which result in an outflow of signal powers between the groups of different users, making it unsuitable. The side lobes of OFDM with filters are improved by proposed methods. However, the performance of the proposed solutions is limited. For instance, in OFDM, CP (Cyclic Prefix) is introduced between two symbols to eliminate inter-symbol interference (ISI). Normally, ISI occurs when channel bandwidth is more than the coherence bandwidth and noise is greater than received signal. However, use of CP in OFDM resulted in wastage of bandwidth [49]. OFDM is recognized to be sensitive to the fast deviation of communication channels. The poor frequency bandwidth of the sub-carrier signals in OFDM is the main root of difficulties that bound the applicability of OFDM system. The above difficulties can be overcome by going through filters that synthesize/investigate the subcarrier signals had trivial side lobes. A motivating, but apparently not extensively implicit, point is that the first multi-carrier technique designed before the creation of OFDM used lot of filters for the examination and synthesis of multi-carrier techniques. These filters can be followed out with low side lobes and consider to be perfect modulation scheme to Cr and multiple access schemes as well as broadband signal spread over unprotected wires. FBMC has diverted a great heap of attention every bit one of the alternates to OFDM, which also occupy an important role in the cognitive radio application [50]. Consequently, several peak power minimization techniques are explored for advanced modulation technique. One of the most challenging issues in a wireless communication system is to increase the capability of the system. In this work, the channel capacity of FBMC and OFDM integrated with Cr is discussed and described. The result reveals that the capacity and gain of FBMC are better than OFDM [50]. In [51] Greedy suboptimal

algorithm based FBMC cognitive radio performance is discussed and analyzed. The primary objective of the proposed study was to efficiently apply the bandwidth without causing any hindrance. The mathematical results of BER and SNR were analyzed to reveal that performance of the FBMC was better than OFDM. In [52] the performance of QAM-FBMC and O-QAM FBMC and the effect of time offset (TO) and carrier frequency offset (CFO) is analyzed and computed. The production of the study reveals that the effect of ISI is greater for O-QAM FBMC because it includes two different filters whose orthogonality criteria are not met. QAM-FBMC utilizes two types of filters whose orthogonality criteria are not satisfied which results in severe ISI. In [21], FBMC is designed to execute a simple synchronization to access the fragmented spectrum, which also cuts the physical channel signaling of the scheme. Additionally, the performance and capacity of OFDM and FBMC are analyzed and compared. Result reveals that FBMC performs better than OFDM. In [53], a new radio wave technique called QAM-FBMC is introduced which overcomes the disadvantage of CP-OFDM. FBMC does not use CP due to which 10–12% efficiency in bandwidth is achieved, but interference due to non-orthogonal filter degrades the BER performance. The work introduced a decision feedback equalization scheme to overcome the interference problem. Outcome also reveals that the proposed radio wave scheme is superior to conventional OFDM system. The transmitter and receiver of OFDM are shown in Fig. 4.

The combination of OFDM with MIMO systems gives tremendous results. It improves the performance of the system significantly. A very compact description of MIMO-OFDM system is mentioned here. The MIMO channel can be given as

$$\begin{aligned} \bar{z}(t) = & H(0)\bar{s}(t) + H(1)\bar{s}(t - 1) + H(2)s(t - 2) + \dots\dots\dots \\ & + H(L - 1)\bar{s}(t - L + 1) + n^-(t) \end{aligned} \tag{6}$$

where

$s^-(t) = Tx$ vector at time(t)

$\bar{s}(t - 1) = Tx$ vector at time($t - 1$)

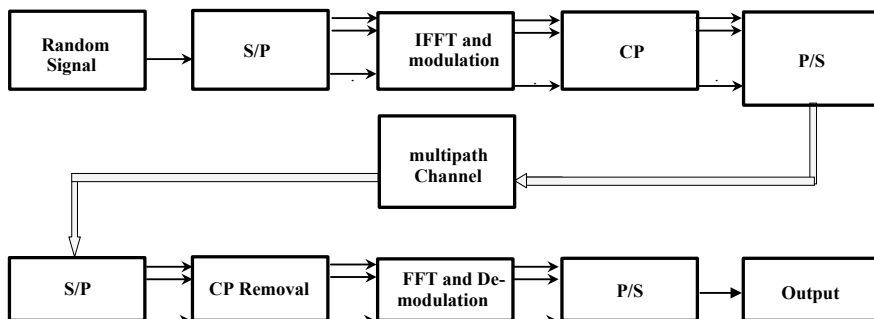

Fig. 4 Block diagram of OFDM transmitter and receiver

$H(L)$ = channel matrix corresponding to tap L . ($N \times M$ matrix);
and $n^-(t)$ = noise

For flat-fading system, the MIMO channel is given as

$$\begin{aligned} z^-(0) &= \bar{H}(0)s^-(0) \\ z^-(1) &= \bar{H}(1)s^-(1) \\ &\vdots \\ z^-(N-1) &= \bar{H}(N-1)s^-(N-1) \end{aligned} \quad (7)$$

In general,

$$\bar{z}(k) = \bar{H}(k)s^-(k) \quad (8)$$

where

$\bar{z}(k)$ = $R \times 1$ receive vector corresponding to subcarrier (k)

$\bar{H}(k)$ = flat fading channel matrix corresponding to the subcarrier (K)

$\bar{s}(k)$ = $T \times 1$ transmit vector corresponding to subcarrier (k).

3.2 Filter Bank Multi-carrier Modulation (FBMC)

FBMC is designed by using a PHYDAS filter at the transmitter and receiver of the system. The filter length is L ($L = K * N$). Haijian et al. (2010) discussed and described the channel capacity of FBMC and OFDM integrated with cognitive radio. Result reveals that the capacity and gain of OFDM are better than FBMC [54]. Won-suk et al. (2014) evaluates the performance of QAM-FBMC and O-QAM FBMC and the effect of time offset (TO) and carrier frequency offset (CFO) is analyzed and computed. The output of the work reveals that the effect of ISI is greater for O-QAM FBMC because it includes two different filters whose orthogonality criteria are not satisfied. QAM-FBMC utilizes two types of filters whose orthogonality criteria are not satisfied which results in severe ISI. Overall, an outcome of the work reveals that QAM-FBMC performance is better for CFO but sensitive to TO as compared to O-QAM-FBMC [55]. Greedy suboptimal algorithm based FBMC cognitive radio performance is discussed and analyzed in this work. The main aim of the proposed work was to efficiently utilize the bandwidth without causing any interference. The numerical results of BER and SNR were analyzed to reveal the performance of the proposed system [56]. Increasing amount of data traffic, capacity, and limited bandwidth is the major challenges in the present scenario. It is also estimated that by the next 4 years, data consumption will increase by 20–30% and presently there are no technologies to support this. Hence, there is an urgency to find a new radio and efficient bandwidth utilization techniques. In this regard, FBMC, a new transmission technique, is the most promising technique for next-generation wireless communi-

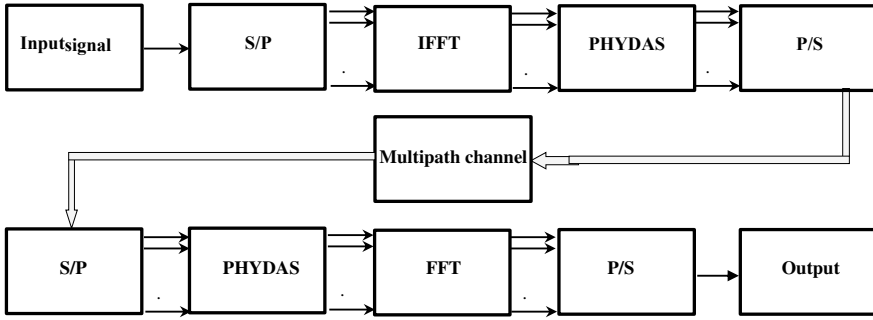

Fig. 5 FBMC block diagram

cation. It includes filters in the transmitter and receiver which motivate to discard the use of OFDM where more than 10% of bandwidth is wasted due to insertion of CP. Additionally, CR better utilizes the unused spectrum by allocating it to needy users. In this work, different spectrum sensing techniques are discussed and described for FBMC and OFDM system. In this work, FBMC is designed to perform a simple synchronization to access the fragmented spectrum, which also reduces the physical channel signaling of the system. Additionally, the performance and capacity of OFDM and FBMC are analyzed and compared [57]. Presently, CP-OFDM is one of the most popular radio techniques used in 4G, WLAN, etc. The performance of OFDM is severely affected by synchronous heterogeneous network environment. A proposed work described a new radio wave technique called QAM-FBMC which overcomes the disadvantage of CP-OFDM. FBMC does not use CP due to which 10–12% efficiency in bandwidth is achieved, but interference due to non-orthogonal filter results in interference which degrade the performance of the system. The work introduced a decision feedback equalization scheme to overcome the interference problem as mentioned above. Outcome also reveals that the proposed radio wave scheme is superior to conventional FBMC system. OFDM-CDMA is designed with multiplexed space-time block codes (STBC) which results in high-spectral transmission efficiency and it also enhanced the performance of space/frequency diversity gain of frequency fading channels. The proposed work is also inexpensive due to the use of less numbers of receiver antennas as compared to transmitter antennas [58]. The structure of FBMC is shown in Fig. 5.

3.3 PAPR in FBMC

FBMC has an overlapping nature and due to this nature we cannot openly apply it to PAPR reduction technique to FBMC. The PAPR for FBMC in time duration can be written as [59]

$$PAPR(x(t))dB = 10 \log_{10} \frac{\max_{mT \leq t \leq (m+1)T} |x(t)|^2}{E[|x(t)|^2]} \quad (9)$$

$i = 0, 1 \dots M + q - 1$, and $E[.]$ called the expectation.

3.4 PHYDAS Filter

The analytical model of PHYDAS filter in time domain is given by following equation:

$$\begin{cases} \left(1 + 2 \sum_{k=1}^{L-1} a_k \cos 2\pi \frac{kt}{Lt}\right) & -LT \leq t \leq \frac{Lt}{2} \\ else & 0 \end{cases} \quad (10)$$

where L is the length of filter and K is the overlapping factor. Stop band performance of PHYDAS filter is excellent for infinite symbols. The design complexity of filter is directly proportional to the length of filter. The impulse and magnitude response of PHYDAS filter are shown below: The impulse response of PHYDAS is not compact which will make it more prone to noise and frequency fading channel, whereas in frequency domain, its response is more compact which make it insensitive to noise and frequency fading channel [60].

3.5 PAPR Reduction Techniques for OFDM

It has several weaknesses, such as CP some part of the system band width is lost, and BER performance is also decreased. The conventional PAPR minimization techniques mentioned cannot be utilized in the FBMC system because of its different structure as compared to OFDM [59].

3.5.1 Conventional Partial Transmit Sequence (PTS)

It represents several signal methods. In this technique, the input signal is segregated into several blocks. These block of signals are converted into time-domain PTS. This shift can be accomplished with the help of IFFT. The output signals are autonomously switched by phase aspects to minimize the peak power [61].

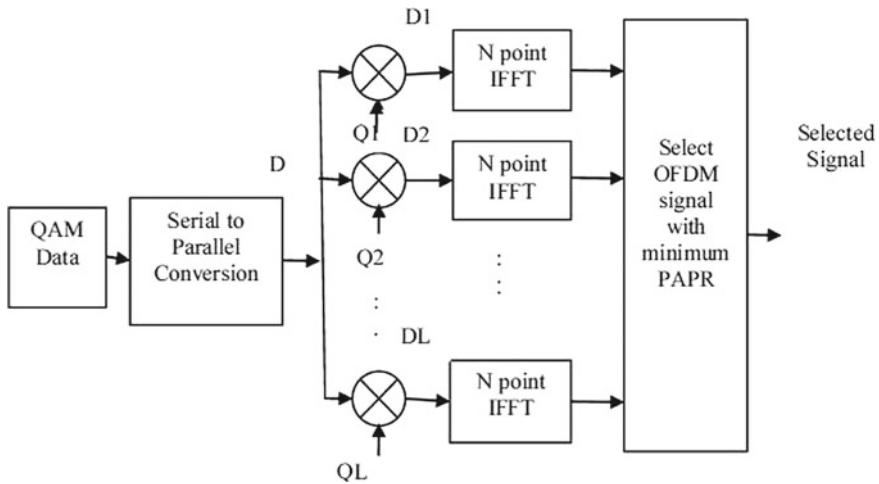

Fig. 6 Selected mapping OFDM system

3.5.2 Conventional Selected Mapping (SLM)

In this scheme, the signal is convolved with each phase series made. And accordingly, arrangements which transfer the identical data are made. From these data's, the reduced PAPR signal is identified for communication [62]. The structure of SLM is indicated in Fig. 6.

3.5.3 Conventional Tone Rejection (TR)

In this method, the peak power is reduced by adding the time-domain signal and orthogonal signal. The main motive is to encompass the constellation and therefore to form the similar signal equivalent to numerous likely constellation [44]. The structure of TR is indicated in Fig. 7.

3.5.4 Conventional Clipping

It is one of the popular peak minimization techniques for OFDM. It is implemented usually at the transmitting part of the system. The introduction of noise is one of the drawbacks of this technique. Table 2 indicates the evaluation of different PAPR reduction techniques.

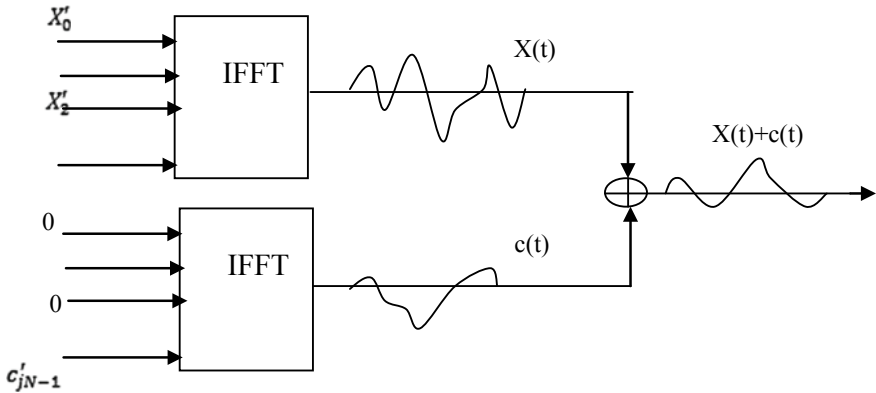

Fig. 7 Block diagram for TR

Table 2 Evaluation of PAPR minimization schemes

PAPR techniques	Advantage	Disadvantage	Operation prerequisite
Block coding	Low noise	High power and loss of data rate	Transmitter: advanced coding require Receiver: advanced coding require
PTS	Low noise and low power	Loss data rate	Transmitter: IDFTs operation require Receiver: information estimation is require
Clipping and filtering	No loss of data rate	High noise	Transmitter: clipping Receiver: no clipping
TR	Simple to implement	High noise, high power, and loss of data	

3.5.5 Signal-to-Noise Ratio (SNR)

How much quantity of information will be carried out by a communication channel is decided by the channel bandwidth and the extent of the noise in the channel. The typical measure of amount of noise present in a system is denoted by SNR. It is expressed mathematically as

$$SNR = P_s/P_n \tag{11}$$

3.5.6 Bit Error Rate (BER)

In digital communication, bits are changed because of interferences, noise added by the channel, error of synchronization, and any other distortions. The number of changed bits received at receiver end is known as bit error. For example, let us consider a sequence of transmitted bits as 1 1 0 0 1 0 1 0 0 1 and the sequence of received bits as 0 1 0 0 1 1 10 0 1. The number of bits changed is 2. Therefore, bit error is 2. The BER is calculated as 2 altered bits divided by total transmitted bits (10 bits), resulting as 0.2 or 20%.

4 Proposed Partial Transmit Sequence

The structure of P-PTS is shown in Fig. 8. The input signal is modulated and converted into parallel form. The signals are divided into numbers of block followed by a precoder and IFFT. Finally, the signals are optimized and summed to generate the reduced PAPR signal. Let the FBMC input signal is given by

$$Y = [Y_1, Y_2, \dots, Y_N]^T \tag{12}$$

$$y(a) = \sum_{i=0}^{v-1} X_i e^{\frac{j2\pi ft}{T}} a_v \tag{13}$$

$$= \sum_{i=0}^{v-1} X_i e^{\frac{j2\pi it}{T}} a_v \sum_{m=0}^{v-1} P_{i,n} y_n \tag{14}$$

$$y(a) = a_v \sum_{m=0}^{v-1} y_n \left(\sum_{i=0}^{v-1} P_{i,n} e^{\frac{j2\pi it}{T}} \right) \tag{15}$$

The PAPR of PTS is given by

$$PAPR \leq \frac{1}{N} \left(\sum_{m=0}^{v-1} y_n \left| p_{i,n} e^{\frac{j2\pi it}{T}} a_v \right. \right) * \left(\sum_{m=0}^{v-1} y_n \left| p_{i,n} e^{\frac{j2\pi it}{T}} a_v \right. \right) \tag{16}$$

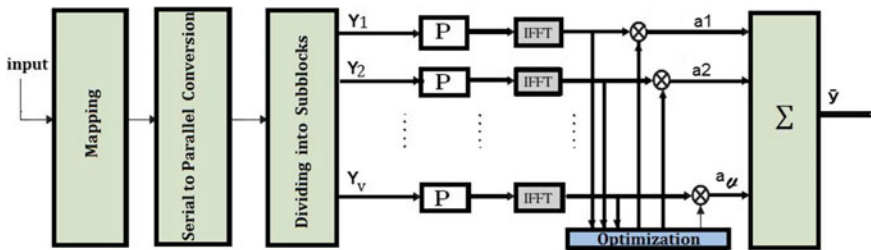

Fig. 8 Proposed modified PTS technique

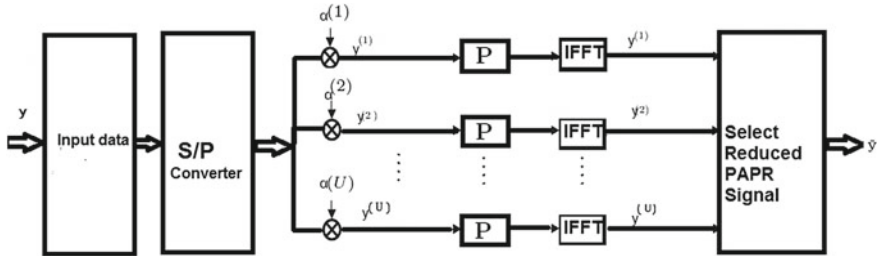

Fig. 9 Proposed SLM technique

4.1 Proposed SLM Technique

The structure of SLM technique is given in Fig. 9. The block of same data is generated by multiplying an FBMC signal with phase factor U . The different FBMC signals are accompanied by precoder and modulator. The structure of minimum PAPR is selected. The multiplication of FBMC input signals and U is given by

$$Y^u = y_{0\alpha_0}, y_{1\alpha_1}, \dots, y_{N-1\alpha_{N-1}} \tag{17}$$

where $U = 1, 2, \dots, U-1$

The precoder output is given by

$$X_m^u = \sum_{k=0}^{N-1} P_{n,k} Y_k^u \tag{18}$$

Taking IFFT of the above equation:

$$y_k^u(t) = \frac{1}{\sqrt{N}} \sum_{n=0}^{N-1} Y_n^u e^{j2\pi n\Delta f_i} \tag{19}$$

5 Results and Discussion

In this work, PAPR reduction schemes will be applied for FBMC. This effect in reduction of power and step-up in capacity. This study will provide fruitful outcomes for further research and analysis regarding next-generation communication systems. Matlab-2014 is used as a designing tool. The simulation parameters are indicated in Table 3.

The performance of conventional and proposed peak power reduction methods is given in Fig. 10. Original PAPR signal is 10 dB at CCDF of 10^{-5} . For CCDF of 10^{-5} , the PAPR of the Clipping, TR, Conventional PTS, and Conventional SLM is 9, 9, 7, 5.9 dB. For proposed PTS and SLM, the PAPR is reduced to 3.8 and 2.9 dB.

Table 3 Simulation parameters

S.no	Parameters
1.	Input symbols: 2048
2.	N = 64
3.	64-QAM
4.	FBMC system
5.	PHYDAS filter Roll of factor = 1 Overlapped symbols = 2

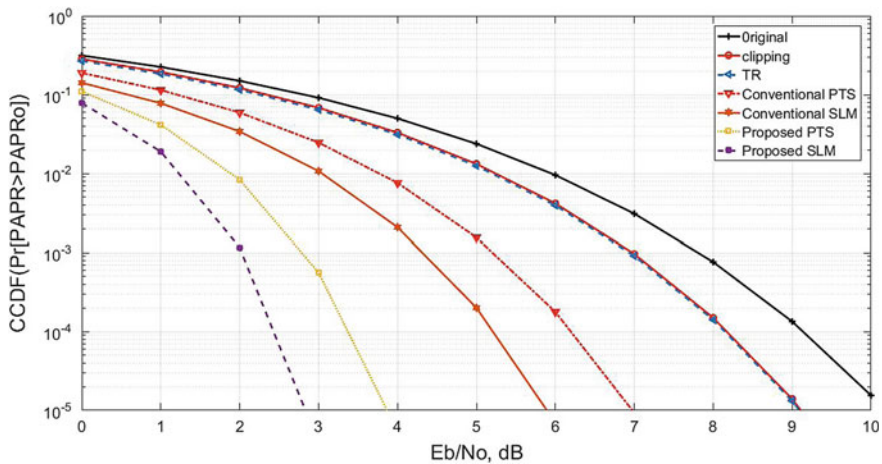

Fig. 10 Conventional and proposed PAPR techniques

Table 4 PAPR values of PAPR reduction techniques

PAPR > PAPR ₀	Original FBMC signal	Clipping	TR	Conventional PTS	Conventional SLM	Proposed PTS	Proposed SLM
10 ⁻⁵	9.5 dB	9.2 dB	9.3 dB	7 dB	5.3 dB	3.4 dB	2.7 dB

The results reveal that the proposed PTS and SLM method perform better than the conventional PAPR reduction techniques. It can be also observed that the proposed SLM technique achieved 1 dB gain as compared to proposed PTS technique. The PAPR values of different PAPR reduction techniques are given in Table 4.

Figure 11 shows the performance of PAPR reduction technique for U = 4 and U = 8. It can be seen that SLM (U = 4) achieved 2 dB gain as compared to the original signal. PTS (U = 4) achieved a gain of 2.2 dB as compared to SLM (U = 4). SLM (U = 8) achieved a 2 dB gain than PTS (U = 8). The value of SLM and PTS for different values of U is given in Table 5.

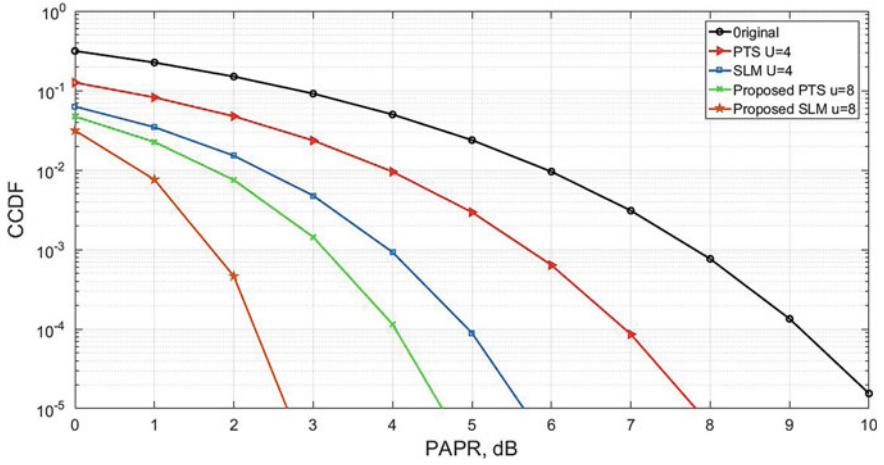

Fig. 11 SLM and PTS for U

Table 5 PAPR values for SLM and PTS for different values of U

PAPR > PAPR _o	Original FBMC signal	PTS(U = 4)	SLM (U = 4)	PTS (U = 8)	SLM (U = 8)
10 ⁻⁵	10 dB	7.9 dB	5.5 dB	4.6 dB	2.7 dB

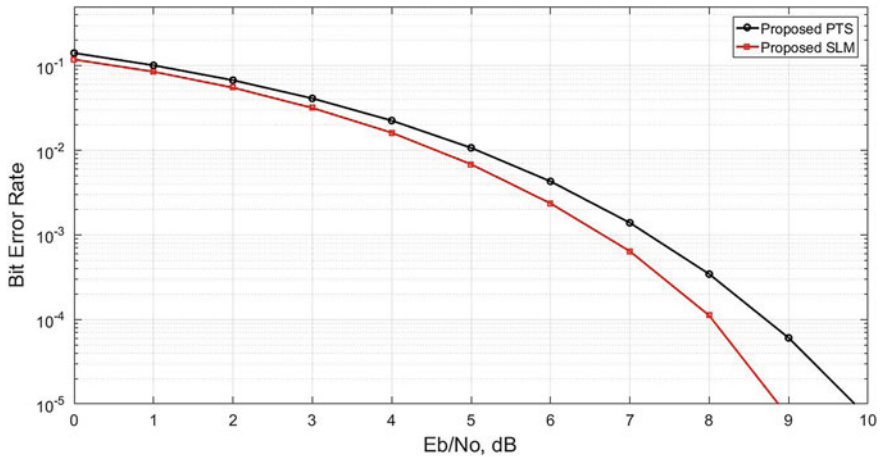

Fig. 12 BER performance of SLM and PTS

Figure 12 shows a BER performance of PTS and SLM PAPR reduction techniques. The output shows that the SLM is superior to PTS.

6 Conclusion

Though this study focused on FBMC in current and forthcoming communication systems, the significance and desired structures of OFDM system cannot be ignored. The purpose is to highlight the point that OFDM, though extensively implemented in the current engineering, is not the best techniques in several next-generation communication systems, more often than not in cognitive radio networks and multiple accesses where FBMC is considered to be more promising. We have proposed a FBMC which do not use CP results in utilization of bandwidth as compared to OFDM (11% of bandwidth is lost). In the proposed study, novel peak reduction methods are implemented, namely, SLM and PTS, respectively. The conventional and proposed PAPR techniques are compared. It was observed that peak power can be cut by using TR, SLM, and conventional PTS for OFDM system. But when we utilized these PAPR reduction techniques in FBMC, the performance of the system degrades because of the overlying arrangement of FBMC. The simulated results indicate that the proposed SLM and PTS techniques performance is better than the conventional PAPR reduction techniques. Further, the efficiency of proposed PTS and SLM is also equated for $U = 4$ and 8 and the simulated results indicate that the proposed SLM gives better result than PTS for $U = 4$ and 8 .

6.1 Future Scope of the Proposed Work

- Orthogonal Issue: Due to the structure and internal distortion, FBMC loses its orthogonality because of waveform overlapping nature in time domain.
- Packet Transmission: The performance of FBMC is excellent for short-range packet transmission but it is unsuitable for long-range packet transmission. Transmitting the information to a long range results in loss of orthogonality between the subcarriers.
- Hardware implementation of FBMC-OQAM P-PTS technique.
- Computational complexity reduction.
- The proposed PAPR reduction techniques of FBMC can be used with MIMO
- Minimum latency.
- Complexity: The use of banks of filter at the transmitter and receiver results in the complexity in the designing of FBMC structure. Further, the use of PAR reduction techniques also adds the complexity design.

References

1. A. Kumar, M. Gupta, A review on OFDM and PAPR reduction techniques. *Am. J. Eng. Appl. Sci.* **8**, 202–209 (2015)

2. A. Kumar, M. Gupta, Reduction of PAPR by using clipping and filtering for different modulation schemes. *Am. J. Appl. Sci.* **12**, 601–605 (2015)
3. A. Kumar, M. Gupta, Design and comparison of MIMO OFDM for different transmission schemes. *Electron. World* **121**, 16–121 (2015)
4. T. Necmi, K. Adem, Y. Mahmut, Partial transmit sequence for PAPR reduction using parallel table search algorithm in OFDM systems. *IEEE Commun. Lett.* **15**, 974–976 (2011)
5. T. Jiang, C. Ni, C. Ye, Y. Wu, K. Luo, A novel multi-block tone reservation scheme for PAPR reduction in OQAM-OFDM systems. *IEEE Trans. Broadcast.* **61**, 717–723 (2015)
6. Y.C. Wang, Z.Q. Luo, Optimized iterative clipping and filtering for PAPR reduction of OFDM signals. *IEEE Trans. Commun.* **59**, 33–37 (2011)
7. A. Kumar, Design, simulation of MIMO & massive MIMO for 5G mobile communication system. *Int. J. Wirel. Mobile Comput.* **14**, 197–206 (2018)
8. A. Kumar, M. Gupta, Design of 4:8 MIMO OFDM with MSE equalizer for different modulation technique. *J. Wirel. Pers. Commun.* **95**, 4535–4560 (2017)
9. S. Ghorpade, S. Sankpal, Behaviour of OFDM system using Matlab simulation. *Int. J. Adv. Comput. Res.* **3**, 67–71 (2013)
10. W. Murtuza, N. Srivastava, Implementation of OFDM based transceiver for IEEE802.11a on FPGA. *Int. J. Adv. Res. Comput. Sci. Softw. Eng.* **4**, 24–28 (2014)
11. Kumari et al., Multimedia big data computing and internet of things applications: a taxonomy and process model. *J. Netw. Comput. Appl.* **124**, 169–195 (2018)
12. V. Divyatha, B.S. Reddy, Design and BER performance of MIMO-OFDM for wireless broad band communication. *Int. J. Mod. Eng. Res.* **3**, 1382–1385 (2013)
13. A. Srivastava, Suitability of big data analytics in indian banking sector to increase revenue and profitability, in *3rd International Conference on Advances in Computing, Communication & Automation (ICACCA-2017)*, Tula Institute, Dehradun, UA, pp. 1–6
14. S. Tanwar, An advanced Internet of Thing based security alert system for smart home, in *International Conference on Computer, Information and Telecommunication Systems (IEEE CITS-2017)*, Dalian University, Dalian, China, 21–23 July 2017 (2017), pp. 25–29
15. H. Yan, L. Wan, S. Zhou, Z. Shi, J.H. Cui, J. Huang, H. Zhou, DSP based receiver implementation for OFDM acoustic modem. *Phys. Commun.* **5**, 22–32 (2012)
16. V.S. Kumar, S. Anuradha, PAPR reduction of FBMC using sliding window tone reservation active constellation extension technique. *J. Electr. Comput. Energ. Electro. Commun. Eng.* **8**, 1555–1559 (2014)
17. I. Shaheen, A. Zekry, F. Newagy, R. Ibrahim, Combined DHT precoding and A-Law companding for PAPR reduction in FBMC/OQAM signals. *Int. J. Comput. Acad. Res.* **6**, 31–39 (2017)
18. N. Raju, S.S. Pillai, Companding and Pulse shaping technique for PAPR reduction in FBMC systems, in *International Conference on Control, Instrumentation, Communication and Computational Technologies* (2015), pp. 265–272
19. A. Kumar, M. Gupta, A Novel modulation technique for 5G mobile communication system. *Am. J. Appl. Sci.* **12**, 601–605 (2015)
20. R. Gopal, S.K. Patra, Combining tone injection and companding techniques for PAPR reduction of FBMC-OQAM system, in *IEEE Global Conference on Communication Technologies (GCCT)* (2015), pp. 321–326
21. Z. Kollar, P. Horvath, PAPR reduction of FBMC by clipping and its iterative compensation. *J. Comput. Netw. Commun.* (2012). <https://doi.org/10.1155/2012/382736>
22. H. Wang, X. Wang, L. Xu, W. Du, Hybrid PAPR reduction scheme for FBMC/OQAM systems based on multi data block PTS and TR methods. *IEEE Access* **4**, 4761–4768 (2016)
23. I. Shaheen, A. Zekry, F. Wagy, R. Ibrahim, PAPR reduction for FBMC/OQAM using hybrid scheme of different precoding transform and mu-law companding. *Int. J. Eng. Technol.* **6**, 154–162 (2017)
24. Z. Kollar, L. Varga, B. Horvath, P. Bakki, J. Bitó, Evaluation of clipping based iterative PAPR reduction techniques for FBMC systems. *Sci. World J.* (2014). <http://dx.doi.org/10.1155/2014/841680> (Hindawi Publishing Corporation)

25. S.K. Bulusu, H. Shaiek, D. Roviras, Reducing the PAPR in FBMC-OQAM systems with low-latency trellis-based SLM technique. *EURASIP J. Adv. Signal Process.* (2016). <https://doi.org/10.1186/s13634-016-0429-9>
26. J. Moon, Y. Nam, E. Choi, B. Chen, J. Kim, Selected data utilization technique for the PAPR reduction of FBMC-OQAM signals, in *ICUFN* (2017), pp. 741–743
27. V. Sandeep, S. Anuradha, PAPR reduction of FBMC using sliding window tone reservation active constellation extension technique. *Int. Sch. Sci. Res. Innov.* **8**, 1555–1559 (2014)
28. R. Shrestha, J. Seo, PAPR reduction in FBMC systems using phase realignment based techniques, in *Proceedings of APCC* (2015), pp. 647–651
29. L. Yu, X. Zhu, X. Cheng, H. Yu, PAPR reduction for OFDMA systems via Kashin's representation, in *IEEE International Conference on Computer and Communications (ICCC)* (2015), pp. 285–289
30. T. Wattanasuwakull, W. Benjapolakul, PAPR reduction for OFDM transmission by using a method of tone reservation and tone injection, in *Fifth International Conference on Information, Communications and Signal Processing* (2005), pp. 273–277
31. H. Chen, A. Haimovich, An iterative method to restore the performance of clipped and filtered OFDM signals, in *IEEE International Conference on Communications, ICC 2003* (2003), pp. 3438–3442
32. Z. Tong, Y. Wang, Z. Guo, The PAPR reduction techniques based on WPT for CO-OFDM systems, in *15th International Conference on Optical Communications and Networks (ICOON)* (2006), pp. 1–3
33. Z. Yi, J. Liu, S. Wang, X. Zeng, J. Lu, PAPR reduction technology based on CSO algorithm in a CO-OFDM system, in *15th International Conference on Optical Communications and Networks (ICOON)* (2016), pp. 1–3
34. M.A. Aboul, E.A. Hagra, E.A.L. EL-Henawy, PAPR reduction for downlink LTE system based on DCT and Hyperbolic Tangent Companding noise cancellation, in *34th National Radio Science Conference (NRSC)* (2017), pp. 238–245
35. B. Lekouaghet, Y. Himeur, A. Boukabou, A. Senouci, A novel clipping based μ -law companding scheme for PAPR reduction over power line communication, in *Seminar on Detection Systems Architectures and Technologies (DAT)* (2017), pp. 1–5
36. N. Van der Neut, B.T. Maharaj, F.H. de Lange, G. Gonzalez, F. Gregorio, J. Cousseau, PAPR reduction in FBMC systems using a smart gradient-project active constellation extension method, in *21st International Conference on Telecommunications (ICT)* (2014), pp. 134–139
37. W. Lingyin, C. Yewen, Improved SLM for PAPR reduction in OFDM systems, in *Intelligent Systems and Applications, ISA 2009* (2009), pp. 1–4
38. I. Shaheen, A. Zekry, F. Newagy, R. Ibrahim, PAPR reduction for FBMC/OQAM using hybrid scheme of different Precoding transform and mu-law companding. *Int. J. Eng. Technol.* **6**, 154–162 (2017)
39. K. Fukumizu, F.R. Bach, M.I. Jordan, Kernel dimension reduction in regression. *Ann. Stat.* **3**, 1871–1905 (2009)
40. J. Armstrong, Peak-to-average power reduction for OFDM by repeated clipping and frequency domain filtering. *Electron. Lett.* **38**, 246–247 (2002)
41. S.K.C. Bulusu, H. Shaiek, D. Roviras, Reducing the PAPR in FBMC-OQAM systems with low-latency trellis-based SLM technique. *EURASIP J. Adv. Signal Process.* **16**, 132–137 (2016)
42. H. Kim, T. Rautio, Weighted selective mapping algorithm for FBMC-OQAM systems, in *IEEE International Conference on Information and Communication Technology Convergence (ICTC)* (2016), pp. 214–219
43. W. Fang, W. Fei, W. Zhenchao, C. Lixia, A novel sub-optimal PTS algorithm for controlling PAPR of OFDM signals, in *Information Theory and Information Security (ICITIS)* (2010), pp. 728–731
44. R. Gopal, S.K. Patra, Combining tone injection and companding techniques for PAPR reduction of FBMC-OQAM system, in *IEEE Global Conference on Communication Technologies (GCCT)* (2015), pp. 709–713

45. A. Kumar, M. Gupta, Key technologies and problem in deployment of 5G mobile communication systems. *Commun. Appl. Electron.* **3**, 4–7 (2015)
46. A. Kumar, M. Gupta, Design of OFDM and PAPR reduction using clipping method, in *Artificial Intelligence and Network Security*, New Delhi (2015), pp. 221–229
47. S.K.C. Bulusu, H. Shaiek, D. Roviras, The potency of trellis-based SLM over symbol-by-symbol approach in reducing PAPR for FBMC-OQAM signals, in *IEEE International Conference on Communications (ICC)* (2015), pp. 4757–4762
48. L. Wang, J. Liu, Cooperative PTS for PAPR reduction in MIMO-OFDM. *Electron. Lett.* **47**, 1–6 (2011)
49. R. Gopal, S. Patra, Combining tone injection and companding techniques for PAPR reduction of FBMC-OQAM system, in *Global Conference on Communication Technologies (GCCT)* (2015), pp. 1–5
50. K. Liu, J. Hou, P. Zhang, Y. Liu, PAPR reduction for FBMC-OQAM systems using P-PTS scheme. *J. China Univ. Posts Telecommun.* **22**, 78–85 (2015)
51. N. Irukulapati, V. Chakka, A. Jain, SLM based PAPR reduction of OFDM signal using new phase sequence. *Electron. Lett.* **45**, 1231–1232
52. H. Wang, X. Wang, L. Xu, W. Du, Hybrid PAPR reduction scheme for FBMC/OQAM systems based on multi data block PTS and Tr methods, in *Special Section on Green Communications and Networking for 5G Wireless* (2016), pp. 4761–4768
53. S.S.K. Bulusu, H. Shaiek, D. Roviras, Reduction of PAPR for FBMC-OQAM systems using dispersive SLM technique, in *Proceedings of the 11th International Conference on Wireless Communications Systems (ISWCS 2014)*, Barcelona, Spain (IEEE, USA, 2014), pp. 568–572
54. R. Zakaria, D. Le Ruyet, Intrinsic interference reduction in a filter bank-based multicarrier using QAM modulation. *Phys. Commun.* **11**, 15–24 (2014)
55. H. Han, H. Kim, N. Kim, H. Park, An enhanced QAM-FBMC scheme with interference mitigation. *IEEE Commun. Lett.* **20**, 2237–2240 (2016)
56. L. Dai, Z. Wang, Z. Yang, Next-generation digital television terrestrial broadcasting systems: key technologies and research trends. *IEEE Commun. Mag.* **50**, 150–158 (2012)
57. D.J.G. Mestdagh, J.L. Gulfo Monsalve, J. Brossier, Green OFDM: a new selected mapping method for OFDM PAPR reduction. *Electron. Lett.* **54**(7), 449–450 (2018)
58. A. Kumar, S. Bharti, Design and performance analysis of OFDM and FBMC modulation techniques. *Sci. Bull. Electr. Eng. Fac.* **17**, 30–34 (2017)
59. A. Kumar, H. Rathore, Reduction of PAPR in FBMC system using different reduction techniques. *J. Opt. Commun.* (2018). <https://doi.org/10.1515/joc-2018-0071>
60. PHYDYAS Project, <http://www.ict-phydyas.org/>
61. V. Pooria, M. Borhanuddin, A low complexity partial transmit sequence for peak to average power ratio reduction in OFDM. *Radio Eng. Syst.* **20**, 677–682 (2011)
62. S. Minkyu, K. Sungyong, S. Jaemin, L. Jaehoon, J. Jichai, DFT-precoded coherent optical OFDM with hermitian symmetry for fiber nonlinearity mitigation. *J. Lightwave Technol.* **30**, 2757–2763 (2012)

Intelligent Personality Analysis on Indicators in IoT-MMBD-Enabled Environment



Rohit Rastogi, D. K. Chaturvedi, Santosh Satya, Navneet Arora, Piyush Trivedi, Akshay Kr. Singh, Amit Kr. Sharma and Ambuj Singh

Abstract Psychologists seek to measure personality to analyze the human behavior through a number of methods. As the personality of an individual affects all aspects of a person's performances, even how he reacts to situations in his social life, academics, job, or personal life. The purpose of this research article is to enlighten the use of personality detection test in an individual's personal, academics, career, or social life, and also provide possible methods to perform personality detection test. One of the possible solutions is to detect the personality, and the study is based on the individual's sense of humor. Throughout the twentieth century, psychologists show an outgoing interest in study of individual's sense of humor. Since individual differences in humor and their relation to psychological well-being can be used to detect the particular personality traits. Machine learning has been used for personality

R. Rastogi (✉) · A. Kr. Singh · A. Kr. Sharma · A. Singh
Department of Computer Science and Engineering, ABESEC, Ghaziabad, India
e-mail: rohit.rastogi@abes.ac.in

A. Kr. Singh
e-mail: akshay.17bcs1075@abes.ac.in

A. Kr. Sharma
e-mail: amit.17bcs1074@abes.ac.in

A. Singh
e-mail: ambuj.17bcs1078@abes.ac.in

D. K. Chaturvedi
Department of Electrical Engineering, DEI, Agra, India
e-mail: dkc.foe@gmail.com

S. Satya
Department of Rural Development, IIT-Delhi, Delhi, India
e-mail: ssatya@rdat.iitd.ernet.in

N. Arora
Department of Mechanical Engineering, IIT-Roorkee, Roorkee, India
e-mail: navneetrorkee@gmail.com

P. Trivedi
Centre of Scientific Spirituality, DSVV, Hardwar, India
e-mail: piyush.trivedi@dsvv.ac.in

© Springer Nature Singapore Pte Ltd. 2020
S. Tanwar et al. (eds.), *Multimedia Big Data Computing for IoT Applications*, Intelligent Systems Reference Library 163,
https://doi.org/10.1007/978-981-13-8759-3_7

detection involves the development and initial validation of questionnaire, which assesses four dimensions relating to individual differences in the uses of humor. Which are Self-enhancing (humor used to enhance self), Affiliative (humor used to enhance the relationship with other), Aggressive (humor used to enhance the self at the expense of others), and Self-defeating (the humor used to enhance relationships at the expense of self). Machine learning is gaining importance, nowadays, as it enables computers to perform self-learning without being programmed for a specific task. Psychologists seek to measure personality through different methods. Nowadays, the human being is so much complex that it is difficult to estimate the personality of an individual manually. The purpose of this chapter is to enlighten the use of personality detection test in academics, job placement, group interaction, and self-reflection. This book chapter provides the use of multimedia and IOT to detect the personality and to analyze the different human behaviors. It also includes the concept of big data for the storage and processing the data, which will be generated while analyzing the personality through IOT. We have used one of the supervised learnings called regression. Algorithms like Linear Regression, Multiple Linear Regression, Decision Tree, and Random Forest are used here for building the model for personality detection test. Among the different algorithms used in the project, Linear Regression and Multiple Linear Regression are proved to be the best so they can be used to implement the prediction of personality of individuals. Decision tree regression model has achieved minimum accuracy as in comparison to others so it is not the model, which can be used for training our model for determining the personality traits of individuals.

Keywords Sense of humor · Personality · Affiliative · Self-enhancing · Self-defeating · Aggressive · Python · Anaconda · Machine learning · Regression · Linear regression · Multiple linear regression · Decision tree · Random forest

1 Introduction

“Personality” has been taken from the word “Persona”. “Persona” is the characterization of a person which is different from his real-life character. Personality can be defined as the sum of characteristics, behavior, and qualities due to which a person is remarked as different or unique. The personality of a person can be described as the habitual behavior and emotional pattern of the person, which evolves from the biological and environmental factors.

The personality of a person can influence the social, personal, and professional life of an individual, therefore, we can use the personality detection test followed by some tasks to develop our personality so as to improve ourselves for better social, personal, and professional life. Personality psychology is the study of the psychology of personality, which analyses the differences in behavior of an individual.

Many approaches have been taken to studying personality, including learning and trait-based theories, biological, cognitive-based theories as well as psychodynamic and humanistic approaches. The possible method we are going to use in this research

article is taking a quiz from individuals and concluding their personality traits on the basis of result. The questionnaire used in this research article is based on the difference of sense of humor of person. The sense of humor of a person is the tendency of an individual to provoke laughter, but the sense of humor or the type of the humor the person uses can accentuate the personality trait of an individual. For example, the person can use the humor for sarcasm or to appreciate anyone or to get attention. Therefore, the sense of humor of a person or their goal for the usage of humor accentuates the personality trait of the individual. Throughout twentieth century, psychologists showed an interest in the study of individual differences in their sense of humor [1].

In the past two decades, researchers interested in detection personality of an individual since the personality of a person can influence the individual’s social, professional as well as personal life so to help them to develop their personality traits.

1.1 Big Data and IOT

Big data is the collection of data set, which is being generated at a tremendous rate around the world. These data can be structured or unstructured. These data are so large and complex that it is difficult to process them by using traditional data processing application. So, to overcome the processing and storage difficulty of big data, an open-source Hadoop is introduced.

Hadoop is an open-source distributed processing framework that is used to store a tremendous amount of data, i.e., big data and also for their processing. Big data has different characteristics which are defined using 4 V’s (Fig. 1) [2].

Internet of Things (abbreviated as IOT) is a system or network, which connects all physical objects to the internet through routers or network devices to collect and share the data without manual intervention.

Fig. 1 The characteristics of big data [8]

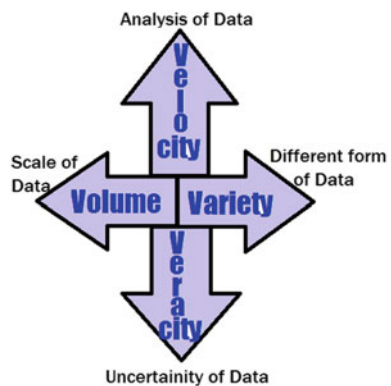

IOT provides a common platform and language for all physical devices to dump their data and to communicate with each other. Data emitted from various sensors are securely provided to the IOT platform and is integrated. Now, necessary and valuable information is extracted. Finally, results are shared with other devices to improve the efficiency and for better user experience automation.

1.2 Cloud Using Fog Computing with Hadoop Framework [3]

In today's world as data is growing at an exponential rate, and the need to store data is also increasingly parallel may be as a memory or as a record. Five–10 years back data is being stored in the hard disks of computers or in the smart phones. But due to the increase in number of profiles of individuals, there was a parallel increase in the data store. This causes to the insufficiency of the storage space, thus forcing more and more people to store their data onto the cloud. The main features of cloud computing are flexibility, scalability, efficiency, and multi-portability. Although cloud provides an excellent option to store the day but still, there are some loopholes in the security which is restricting the users from using cloud. Therefore, instead of securing the data only by authentication credentials like user name and password, an approach of using fog computing that is concoction of user's profile mapping using various behavior parameters and decoy data technology that is having a fake file of every file format, which will be used to launch a disinformation attack in case the user gets detected as an intruder came into being in order to maintain confidentiality of data. Thus, by getting large data set, our accuracy on personality in detecting human behavior will surely get increased.

1.3 Guiding Principles of Mist Computing [4]

Network [5] must provide information but not simply data. The network should deliver only information that has been requested and only when it has been requested. Dynamic creation of a system is based on information needs with end devices working together using a subscriber provider model. Devices must be situation aware, they must adapt to the information needs and the network configuration. We should not have static binding's rules for device and data providers. The devices must dynamically discover the data providers and execute the application.

Traditional wireless routing protocols are not suitable for routing in mist computing. Here, the routing protocols support device-to-device connectivity. It has been observed that suboptimal routing paths increase the bandwidth requirements of the network. Also, in mist, any node should be able to connect to any gateway eliminating dependence on a specific gateway. In a huge network, sometimes gateway failures force addition of a new gateway, the nodes near that gateway should have the ability to connect dynamically to such a node and a new route between itself

and the gateway efficiently established so that the crisis of information unavailability is solved within the tolerance time [6].

As we can observe in above representation, the mist nodes are responsible to process the data which has to be handed over to the IOT devices, which include the sensors and actuators with a physical connection among themselves. The mist node also monitors the quality of link parameters. At the gateway level, the functionalities are loading updated application rules and tuning application parameters, monitoring the health of local nodes, execution of computationally intensive services. Finally, at the cloud level, new applications can be deployed and applications can be coordinated along with service quality monitoring and monitoring health of the running applications [7].

1.4 Edge Computing [8]

Almost every use case and every connected device focused on by the Industrial Internet Consortium (IIC) require some sort of compute capability at its source, at the edge. Multiple sources define edge computing as “cloud computing systems that perform data processing at the edge of the network, near the source of the data”. While this is certainly true, it only scratches the surface of the immense power and remarkable capabilities that edge computing applications and architectures can provide to solve industrial internet users toughest challenges. But, as is typical with any powerful technology, innovative architectures and new terminology are needed to facilitate implementation, bringing increased complexity with it.

Interviews in corporate, during hiring procedure and ever for selecting the person in companies, for example, in agile software development methodology, it is very important to find the right person for the particular job. Personality tests in government organizations, As the jobs like them demands different characteristics and personality of an individual, for example, the ORQ (officer-like qualities are needed in defense some special characteristics are needed in IAS officer, that can differ from the characteristics needed for an IPS officer so in order to find right candidate the personality detection can be a great help.

It can help the aspirants of such jobs which need a good personality. So, they can prepare by working on their personality as if they will know the problem than they can easily find the solution.

This method can be used by the user to develop their personality. This method can be used in companies also to give appropriate work to appropriate employee according to their personality (nowadays, it is used in agile methodology of software development where the attitude of an employee plays a very important role). This program can be used in selection in defense, as the main requirement in defense is attitude and personality. This program can be used by the aspirants also to prepare for particular jobs or exams.

2 Effect of Personality in Person's Life

“Personality” has been taken from the word “Persona”. “Persona” is the characterization of a person which is different from his real life character. Personality can be defined as the sum of characteristics, behavior, and qualities due to which a person is remarked as different or unique. The personality of a person can be described as the habitual behavior and emotional pattern of the person which evolves from the biological and environmental factors.

The personality of a person can influence the social, personal, and professional life of an individual, therefore, we can use the personality detection test followed by some tasks to develop our personality so as to improve ourselves for better social, personal and professional life. Personality psychology is the study of the psychology of personality which analyses the differences in behavior of an individual [9].

The personality of a person can influence their social life. Personality of an individual influence his behavior, thought process, and actions, which affects the social life of a person. Personality trait such as aggressive can have a negative impact on the individual's life whereas the personality trait such as openness to experience can have the positive impact on individual's life. Today is the world of digitalization, people like to have a interactive and happy civic life or like to pretend in that way, which can be analyzed from their social networking accounts. People use humor to hide their feelings, they like to pretend and hide all the sentiments in humor.

The personality of a person can affect their personal life, today, everyone is so much busy in their careers and pretend to be happy in social networking sites that they forget to spend time with their closed ones. The personality of an individual directly influences the priorities of an individual.

How an individual behaves in different situations affects the relationships of an individual, personality of an individual can either eases the person's life of a person or can make it much difficult for that person.

The personality of a person can affect their professional life, in a workplace environment, the attitude of an individual is important. Someone's personality can be cheerful and upbeat. These are the person who fills their surrounding with happiness and has always positive thinking. Likewise, no one wants to work with those who have negative attitude as they make the environment unhealthy. In contrast, people with a positive attitude bring enthusiasm in workplace. Therefore, personality is very important in the professional life of an individual [10].

Therefore, we can use the personality detection test to examine our weakness and strengths so that we can improve our personality to make our social, personal and professional life better.

Various studies by researchers and psychologists have done to detect the personality traits of a person through learning and trait-based theories, biological, cognitive-based theories, and humanistic approaches. One possible method for personality detection test is to develop a questionnaire based on the basis of the answers given by the participants, and the personality trait of the individual can be predicted.

Various personality traits are defined by the human characteristics. It can be Optimistic, Realistic, Leader, Listener, Writer, Enthusiastic, Attentive, Responsible, Smart Kind, etc. [11].

3 Data Description

For data preparation, (Table 1), dataset is taken from “Martin, R. A., Puhlik-Doris, P., Larsen, G., Gray, J., & Weir, K. (2003). Individual differences in uses of humor and their relation to psychological well-being: Development of the Humor Styles Questionnaire. *Journal of Research in Personality*, 37(1), 48–75”.

Machine Learning is a study which performs learning without being explicitly programmed. So, if we want our program to predict the personality, we can run different machine learning algorithms with data of some previously performed personality test (Experience) and if learning is successfully done then, it will help in performing better prediction. We have used one of the supervised learning algorithms called regression. Regression is a modeling and analyzing technique, which computes the relationship between target (dependent variables) and predictors (independent variables). Regression allows comparing the effects of algorithms on variables of dataset. To make predictions, various kinds of regression techniques are available:

- **Linear Regression**—One of the most widely used techniques. It establishes the relation between independent variables (one or more) and dependent variable using a best-fit regression line. It is represented by an equation

Table 1 Column metadata

Features	Feature description	Data type
32 set of questions	These were statements rated on a five-point scale where 1 = Never or very rarely true, 2 = Rarely true, 3 = Sometimes true, 4 = Often true, 5 = Very often or always true (-1 = did not select an answer)	Numeric
Age	People of 14–87 years of age group	Numeric
Gender	Gender defines here the comparison of personality traits (1 = male, 2 = female, 3 = other)	Numeric
Accuracy	It is given by the users revealing that how much predictions are correct according to them. Scale (0–100)	Numeric
Affiliative	Who establish connections easily with others? Scale (1–5)	Numeric
Self-enhancing	Who makes people feel positive about themselves? Scale (1–5)	Numeric
Aggressive	It depicts the emotional distress and person who is likely ready to attack or confront. Scale (1–5)	Numeric
Self-defeating	Who works against himself/herself and unable to achieve the desired result. Scale (1–5)	Numeric

$$Y = b + aX + e \quad (1)$$

where b is an intercept, a is slope of line and e is error.

- **Multiple Linear Regression**—It is the most common form of linear regression analysis. It helps to establish the relationship when dependent variable is not only dependent on any one independent variable but on multiple independent variables. It is represented by an equation

$$Y = a_0x_0 + a_1x_1 + a_2x_2 + \dots + a_kx_k + e \quad (2)$$

where Y is response by k predictor variable $x_1, x_2, x_3 \dots x_k$; $a_0, a_1, a_2 \dots a_k$ are regression coefficients and e is the error.

It consists of five methods of building models, namely, All in, Backward Elimination, Forward Selection, Bidirectional Elimination, and Score Comparison.

- **Decision Tree Regression**—Decision tree algorithms are nonparametric supervised learning algorithms that are used for building regression and classification models, through this algorithm, we try to train our model to predict values of target variable by learning decision rule inferred from data features. Decision trees are able to manage both numeric and categorical data and they can also handle multi-output problems.
- **Random Forest Regression**—Random forest is like a forest of decision trees, i.e., it takes decision based on various decision trees. The final model of this technique is developed by the base models of various decision trees. It uses averaging for improving the predictive accuracy and controlling the over fitting. The equation used in this technique: $h_x = k_0x + k_1x + k_2x + k_3x + \dots$ here, h_x is final model and $k_0x, k_1x, k_2x, k_3x \dots$, are base models.

4 Previous Work Study

In a survey of Personality Computing [12], according to Alessandro Vienciarelli, Gelareh Mohammadi researches, personality can be explained by a few measurable individual characteristics. We can use various technologies (i.e., which can deal with human personalities) for personality computing approaches, i.e., understanding, prediction and synthesis of the human behavior This paper is a survey of such approaches and it provides the three main problems indicated in literature, i.e., (1) Automatic Recognition of personality, (2) Automatic Perception of personality, and (3) Automatic synthesis of Personality.

In results of Personality Recognition on Social Media with Label Distribution Learning [13], the main aim of the experiment was to efficiently, reliably, and validly recognize an individual's personality. Di Xue, Zheng Hong, and Shize Guo have stated the traditional ways of personality assessment are interviews, quiz prepared by the psychologists but these are expensive and not much practical in the social

media domain. It proposes the method of big five Personality Recognitions (PRs) with a new machine learning paradigm named label distribution learning. Out of 994 features, 113 features were extracted from active profiles and microblogs. Nine nontrivial conventional machine learning algorithms and eight LDL algorithms are used to train the personality traits prediction models. Results show that two of the proposed LDL approaches outperform in predictive ability.

In the development of Agile Person Identification through Personality Test and k-NN Classification Technique [14] Software methodology is a planning of the development of software; agile methodology is one of the most efficient software development methods. Agile method requires the cooperation and understanding between the employees, so this is important for the software project manager to assign the right work to the right people. Rintaspon Bhannarai, Chartchai Doungsa-ard have revealed the fact that the researchers provide five personality traits to predict suitable people for the agile method. A predicting method is done by using k-NN (k-nearest neighbor) classification technique. The k-NN techniques classify the unknown data from the known data by comparing the distance calculated between them. The most common method to calculate the distance between data is using Euclidian Distance. Using the participants, which involve software developers, testers, managers, etc., the pilot study is used to explore this technique that k-NN technique can be explored to predict the correct people for agile method.

In view to check individual differences in sense of humor and their relation with psychological well-being [15], the main aim of this survey was to identify the most common personality traits in males and females and which traits dominate in male and female. Here, the analysis was done by the quiz which was developed on the basis of different sense of humors of a person. After collecting the data from candidates, the analysis was done on the basis of some particular personality traits. Rod A. Martin, Patricia Puhlik-Doris, Gwen Larsen, Jeanette Gray, and Kelly Weir are the authors of related work and focused on the difference in individual's sense of humor and on the basis of that observation, they characterized the individual in terms of four personality traits that are aggressive, affiliative, self-enhancing, and self-defeating. The objective of the experiment was to analyze the proportionality of these personality traits in male and female.

To understand the product functions and operations, the personality detection test will predict the personality of an individual on the basis of four personality traits that are aggressive, affiliative, self-enhancing, self-defeating. It anticipates the personality of an individual by giving the dominance of each personality trait (aggressive, affiliative, self-enhancing, and self-defeating) in the range of 0–5. If the particular personality trait is 0 that means it is least in the particular person and if it reaches near 5 that means it is a very dominant personality trait in an individual.

The personality development test will first collect the input from the user/participant, when the user will perform the quiz. The answers collected will be used as the data, which will be passed to the multiple machine learning algorithms. The machine learning algorithms will predict the result on the basis of training set memory constraints—to run a python programs, 2 GB memory is required.

Operations that will be done by user are 1. The user/participant will perform the quiz, 2. On the basis of the result, they will try to develop their personality as they will be aware about their strengths and weaknesses to accomplish a healthy and successful life.

5 Supervised Learning with Regression Analysis Using Python Language

Python is a free and open source, simple and interpreted, object-oriented, and extensible language. Python uses NumPy and Pandas, Scikit-learn, Model Evaluation and Validation, Training and Testing, and Metrics for evaluation in the process of data analysis and training. It serves several benefits as most appropriate for machine learning as open source–open software license with GPL compatible. It is proved highly versatile with Scikit-learn machine learning library. It uses Pandas for data munging, NumPy for data representation, matplotlib for visualization, and Django for web application integration. It is faster and easier to develop prototypes. Python language is supported by for deep learning framework by Google (<https://www.tensorflow.org/>), and is used in Hadoop streaming in many industries.

Supervised learning [16] is used to train the model with some examples of a pair of input and output. Supervised learning algorithms use the training set, which is a set of data used to train the model. On the basis of the training set of data and learning of model, the result for other inputs can be inferred. The testing data set is used to verify the performance of the model or the accuracy of model. The test data set is some part of initial data set as the output will already be available so that we will have to compare the original output with inferred output to check the accuracy of model (Figs. 2 and 3).

Regression analysis and its Gantt Chart (Fig. 4a, b) are a set of statistical processes, which are used for estimating the relationship among variables. It provides many techniques for modeling and analyzing several variables. Regression analysis mainly focuses on the relationship between dependent variable and one or more independent variable (or we can call independent variable as predictors). It mainly focuses to understand how the typical value of the criterion variable (dependent variable) changes when any one of the predictors is varied and other predictors are fixed. Prediction and forecasting are the most common application of regression analysis [17]. The following are the various regression techniques:

Linear Regression, Multiple Regression, Decision tree Regression, and Random Forest Regression.

The following steps are taken in the process of regression analysis:

1. **Raw Dataset:** Once the raw dataset is collected and the data is refined for the analysis. Then, the data is partitioned into train dataset and test dataset. The data set contains the column of input variables and output variables, which is used to train the model for predicting the result using regression analysis techniques or

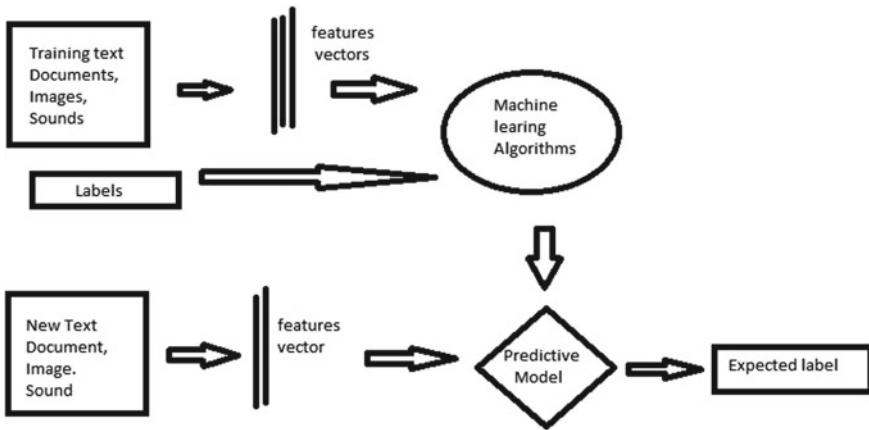

Fig. 2 Methodology of supervised learning [22]

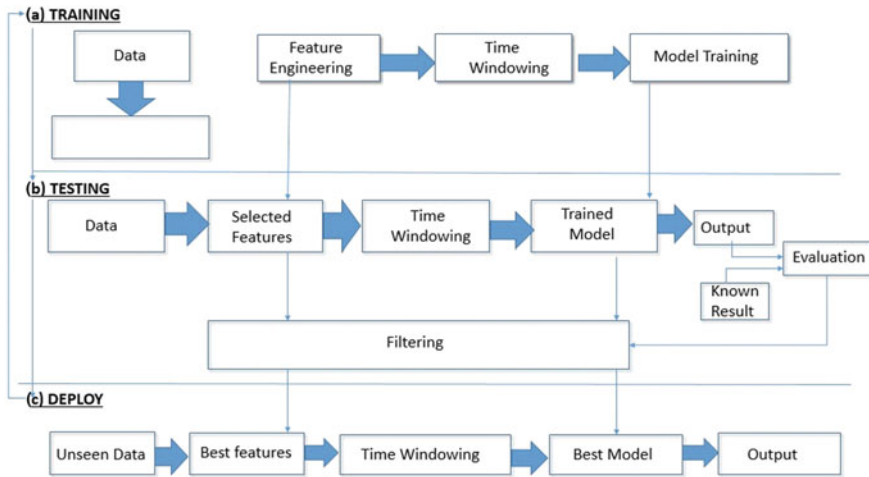
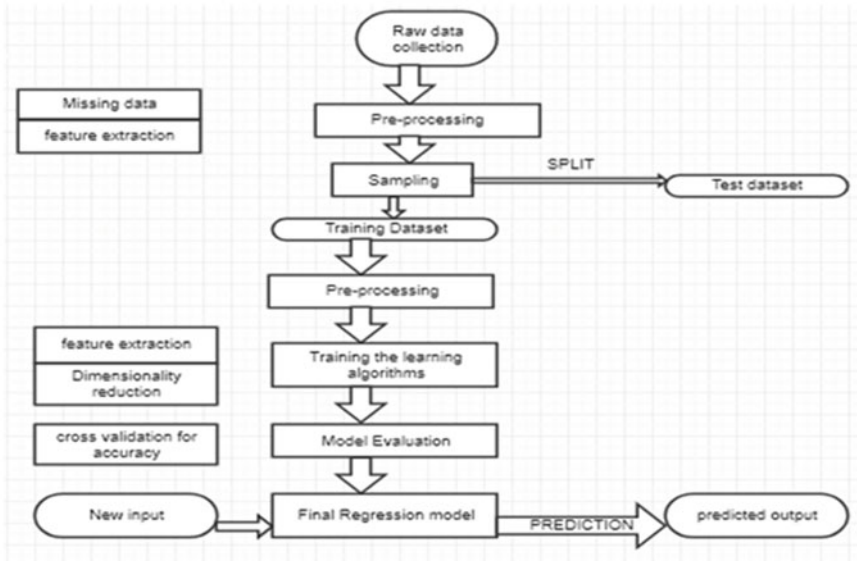

Fig. 3 Iterative process of constructing and applying ML-based prediction models [23]

regression algorithms. Here, the entire dataset is into 80:20 ratio, where training is done on 80% data and cross-validation is done on 20% data.

2. Train the Model: Here, data processing is done. Train data is used to train different models. The best model is chosen among them. Data processing involves removal of nonnumeric data columns, NA, and NAN terms from the data frame. It is done either by replacing them with 0 or replacing the attribute value with its mean or median value. Then, individual models are built using different algorithms from the packages like Caret, rpart, etc., from R and Scikit, sklearn from Python.
3. Get Best Model: After training the model using different regression algorithms, the comparison between those algorithms is done by finding the accuracy of each

(a)



(b)

	Task	Start	End	Dur	%	2017		2018		
						Q4	Q1	Q2	Q3	Q4
	Project on Personality Detection	5/11/17	18/10/18	240		[Gantt bar spanning Q4 2017 to Q4 2018]				
1	Data Study and Research	5/11/17	2/3/18	80		[Gantt bar from 5/11/17 to 2/3/18]				
2	Fetching Dataset	15/1/18	23/3/18	48		[Gantt bar from 15/1/18 to 23/3/18]				
3	Algorithm Research	15/2/18	15/4/18	41		[Gantt bar from 15/2/18 to 15/4/18]				
4	Implementation	16/4/18	15/6/18	44		[Gantt bar from 16/4/18 to 15/6/18]				
5	Performance Analysis and Reporting	16/6/18	18/10/18	86		[Gantt bar from 16/6/18 to 18/10/18]				

Fig. 4 a Flowchart of regression analysis. b Gantt chart of activity

model using test data set for validation and calculating the accuracies of each model. After comparing the accuracies of each model and limitations, the best model is selected for further predictions.

4. Get prediction of the new dataset: Once the most accurate model is selected and trained, the new data set can be applied to the model as input and the output can be predicted using trained model and machine learning algorithms.

6 Study Plot

The dataset consists of the Humor Style Questionnaire [18]. Dimensions of data are 39 attributes and 1071 instances. There are no missing values in the dataset. Now, while exploring the dataset

- Step 1** Apply data ETL operations
i.e., Apply data feature extraction, Data Transformation, Loading of dataset.
[Loop Begins] Till all the dataset is completed.
- Step 2** Estimation of summary of each attribute including max, min, mean, count value and also some percentiles.
- Step 3** Check for any null value.
- Step 4** Check the data type of various attributes in dataset.
[End of Loop].

For data visualization first, we start with univariate plots that is, the plot of each variable to get an idea of the distribution (Fig. 5).

7 Algorithm(s) Implementation Results—Graphs and Tables

The graphs above (Figs. 6, 7, 8, and 9) show the range of different personalities among individuals. The use of machine language IOT has helped to detect the different personalities among the people. For detection of each personality, separate graphs are used, hence the data obtained are large and these tremendous amounts of data can be handled by the help of big data only.

The next step is data preprocessing where we initially declare dependent and independent variables. Splitting of the dataset into Training set and Test set. Dataset is split in ratio of 80:20. In other words, 80% of the data is kept in training set and 20% data is kept in test set. Now, we have a training data in X_train and Y_train and test data in X_test and Y_test. We are building some ML models by establishing the correlation between dependent variable and independent variable and once the correlation estimated then, we will test the model using test data (X_test and Y_test) that whether it can understand the correlation between the training set on test set.

Prediction is an action performed on the test data to forecast the values that up to which extent model has learned from the trained data. Predicted values help in estimating the degree that how much accurate model has learned and able to predict the values (Figs. 6, 7, 8, and 9).

Building of models enables us to know that which model is best for learning to perform further computations. As different regression models like Linear Regression (by Eq. 1), Multiple Linear Regression, Decision Tree Regression, and Random Forest Regression. Machine learning regressors usually support a single dependent variable. So, here we create multi-output regressors for Multiple Linear Regression

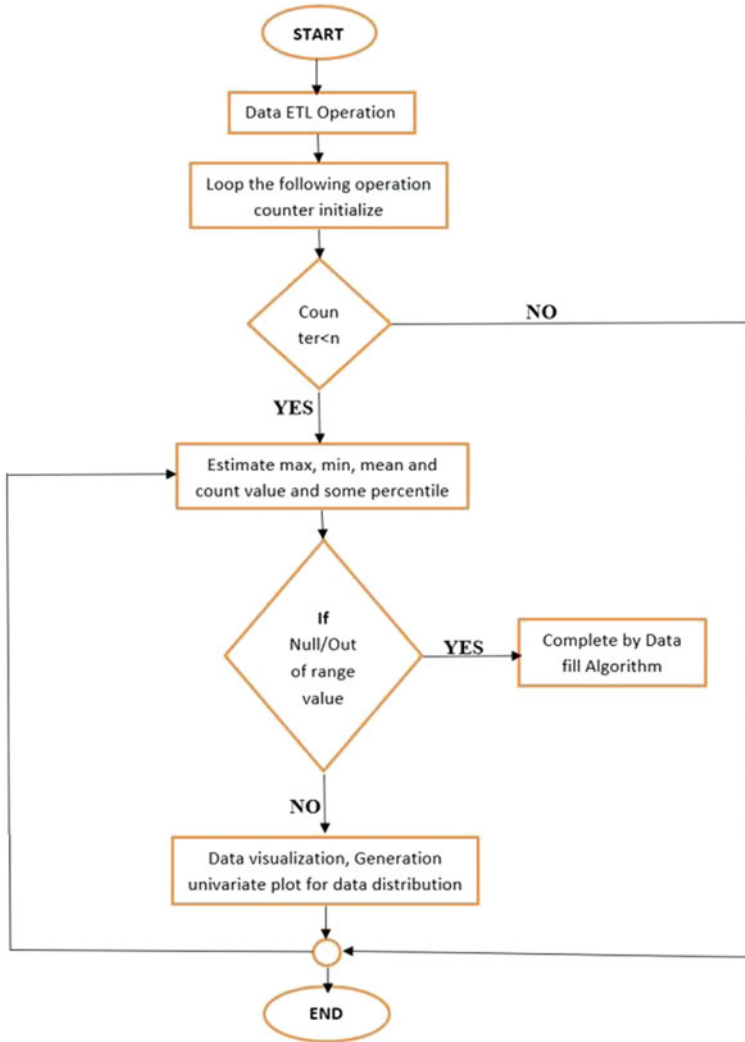

Fig. 5 The flowchart of algorithm applied

(by Eq. 2), Decision Tree Regression, and Random Forest Regression. This strategy consists of fitting one regressor for each target. Prediction and accuracy of multi output regressor for each model is computed. The graphs below (Figs. 10, 11, 12, 13, 14, 15, 16, 17, 18, 19, 20, 21, and 22) gives the visualization of predicted and tested values and shows that predicted values are how much close to tested values. Since accuracy is the most important parameter to decide that which regression technique is best and the accuracy will be achieved only if these large amounts of data, i.e., big data are processed and stored properly (Figs. 23, 24, 25, and 26).

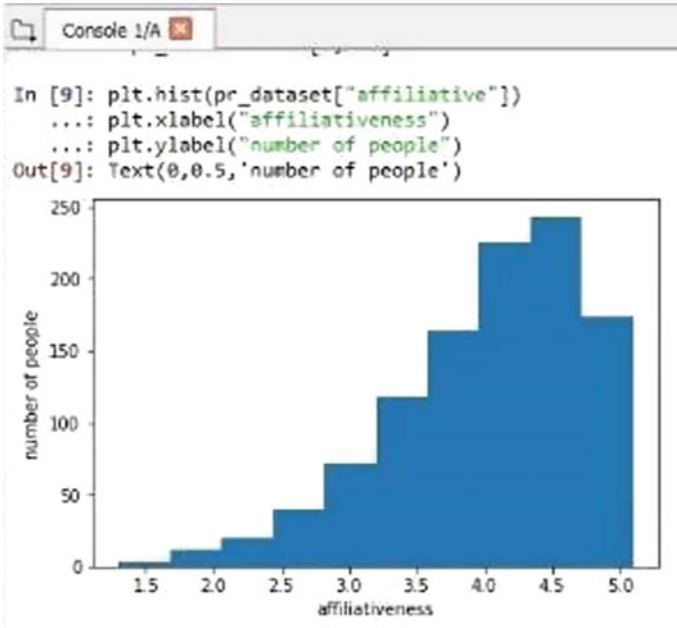

Fig. 6 It shows range of affiliative personality among individuals

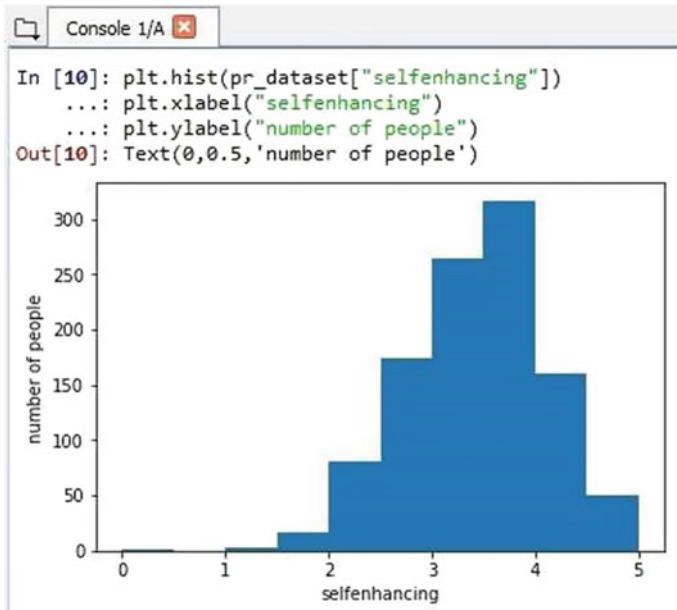

Fig. 7 It shows the range of self-enhancing personality among individuals



Fig. 8 It shows the range of aggressiveness personality among individuals

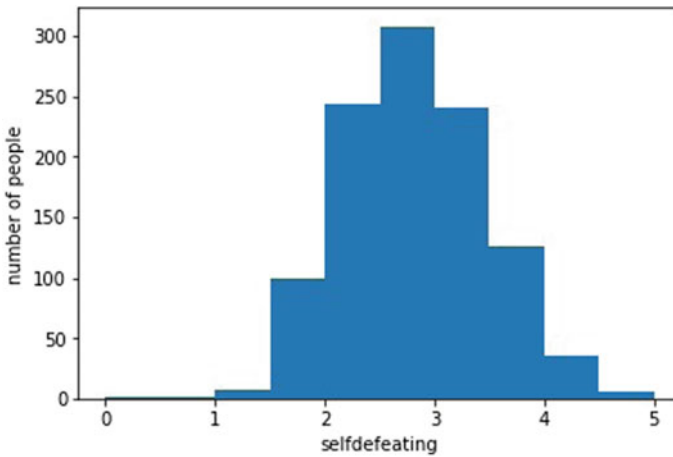

Fig. 9 It shows range of self-defeating personality among individuals

Decision Tree Regression2 and Decision Tree Regression4 achieve almost same accuracy that is, near to 70%.

Least accurate is Decision Tree Regression3 of 28.75% accuracy. Average accuracy of Decision Tree Regression is 64.175%. This method doesn't give the best result. Many times, IOT device collects the data but the data are very complex so it is not able to give good result by this regressions.

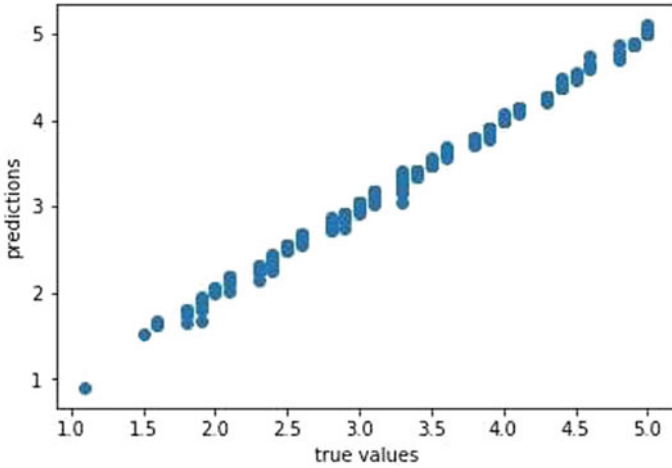

Fig. 10 This graph shows the relationship between the tested and predicted values computed from Linear Regression model. As we can see in the graph, blue color dots are coinciding with each other and are not scattered in the whole plane because the predicted values are very close to the tested values. Accuracy achieved is 99.56% with mean square regression loss is 0.00156390272662

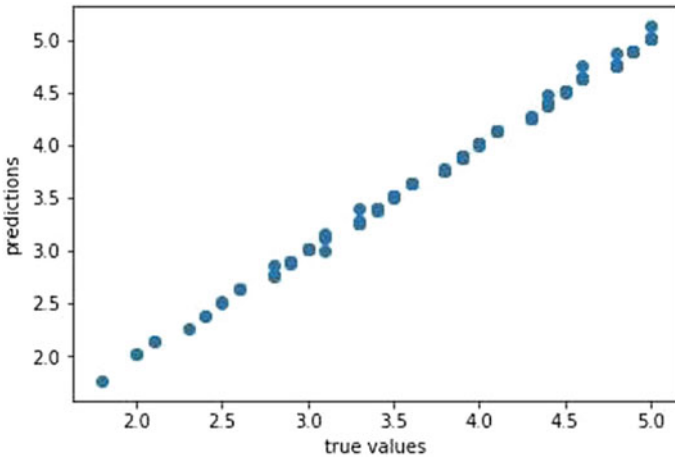

Fig. 11 This graph shows the relationship between the tested and predicted values of Multiple Linear Regression1. The dots are lying very close to each other and are also not scattered in whole plane so it shows that predicted values are very much accurate with accuracy 99.79%. Mean square regression loss is 0.00111408573375

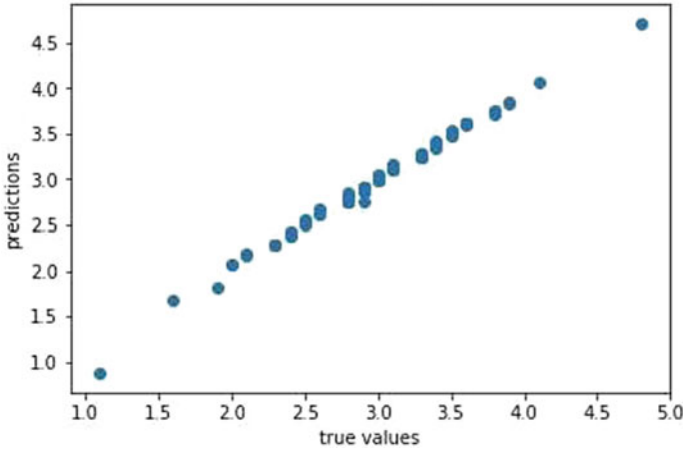

Fig. 12 Visualization of predicted and tested values of Multiple Linear Regression2. This model also predicts the accurate results and this is clearly visible through scattering of points linearly in a plane. Accuracy is 99.51% and mean square regression loss is 0.00169502757472

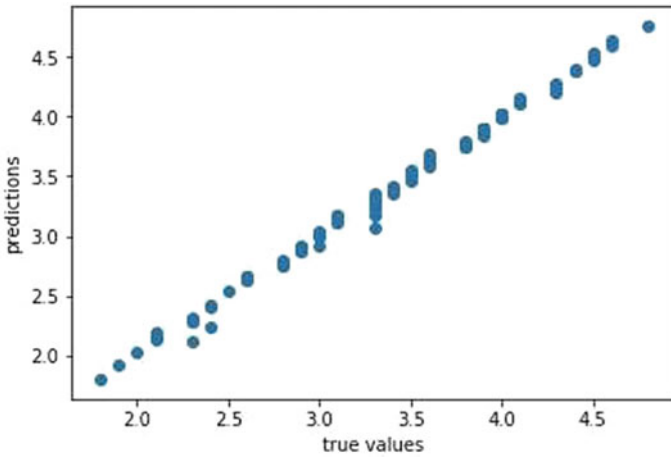

Fig. 13 Visualization of predicted and tested values of Multiple Linear Regression3. This model also predicts the accurate result but in comparison to Multiple Linear Regression1 and Multiple Linear Regression2m there is minor difference in accuracy. Accuracy is 99.14% and mean square regression loss 0.00159577024357

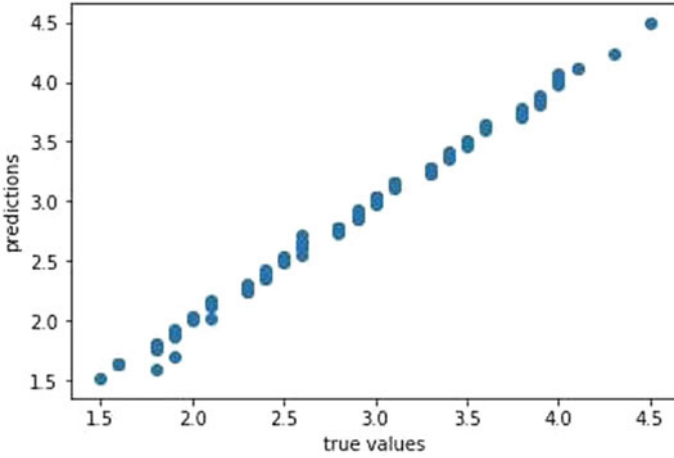

Fig. 14 Visualization of predicted and tested values of Multiple Linear Regression4. This model predicts the accurate results with accuracy of 99.56% and mean square regression loss is 0.00159151039372

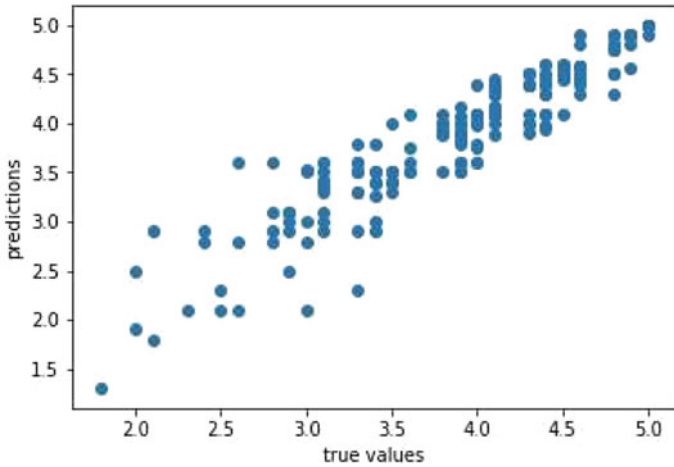

Fig. 15 Visualization of predicted and tested values of Decision Tree Regression1. As we can see in the graphm all points are scattered in a plane because the prediction is not much accurate as in case of Linear regression and Multiple Linear Regression. Scattering shows that predicted and test values are not lying much close to each other. Accuracy is 87.52% and mean square regression loss is 0.0675178855488

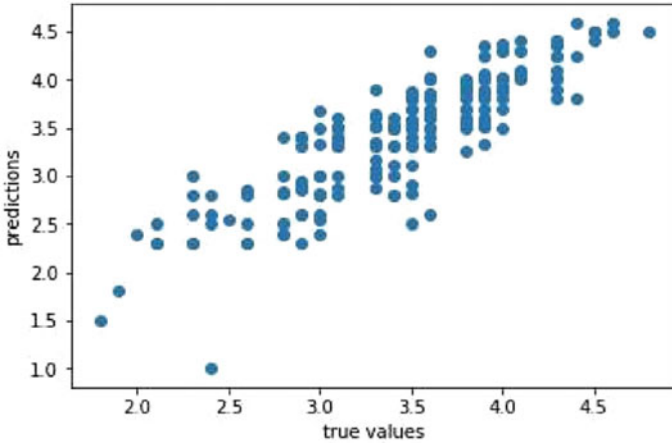

Fig. 16 Visualization of predicted and tested values of Decision Tree Regression2. In this graph, the points are much scattered initially that is, lying at some distance. It is a good model but not accurate model as in comparison to Decision Tree Regression1. Accuracy is 71.48% and mean square regression loss is 0.0984915683583

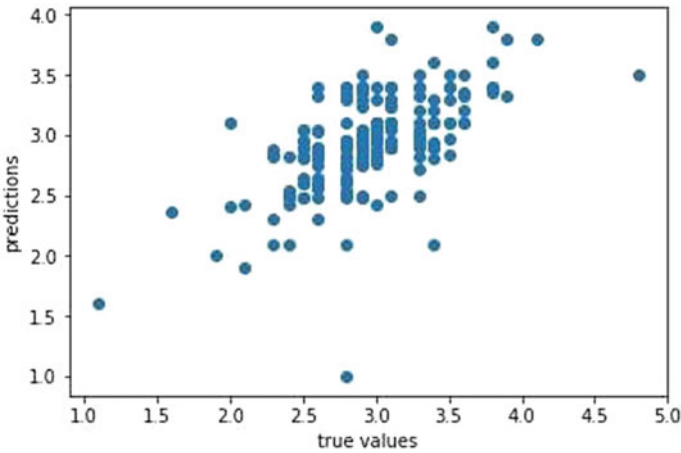

Fig. 17 Visualization of predicted and tested values of Decision Tree Regression3. This model is least accurate as we can see in the graph that points are clustered at various places and are not scattered linearly. This is model has very less accuracy. Accuracy is 28.75% and mean square regression loss 0.132380568167

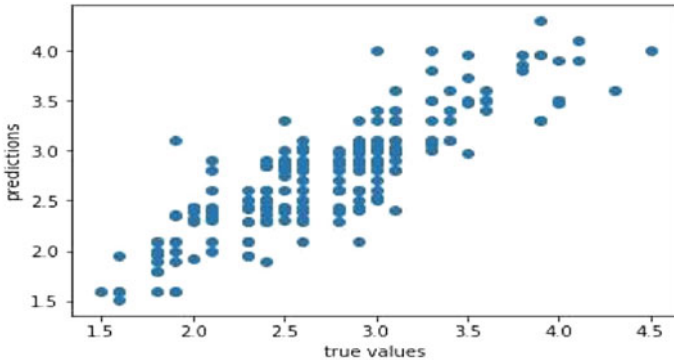

Fig. 18 Visualization of predicted and tested values of Decision Tree Regression4. This is far better than Decision Tree Regression3 as we can see that points are scattered in the linear form. This is very much similar to Decision Tree Regression2 in terms of prediction. Accuracy is 72.84% and mean square regression loss is 0.0982561775804

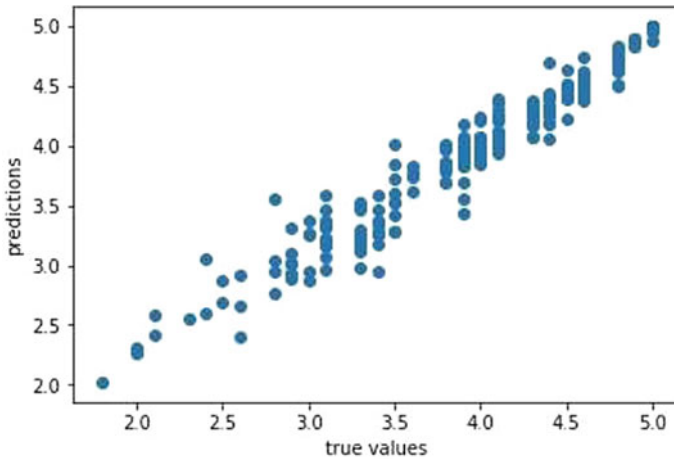

Fig. 19 Visualization of predicted and tested values of Random ForestRegression1. This is accurate model as in comparison to Decision Tree Regression where average accuracy is 65.1475%. All points are scattered linearly in a plane. So, better predictions are obtained. Accuracy is 94.16% and mean square regression loss is 0.0315995487491

8 Performance Evaluation, Learning and Outcomes, Product Perspective

Among the different algorithms used in the project, Linear Regression and Multiple Linear Regression are proved to be the best. Both of them are the best algorithm that can be used to implement the prediction of personality of individuals. On the

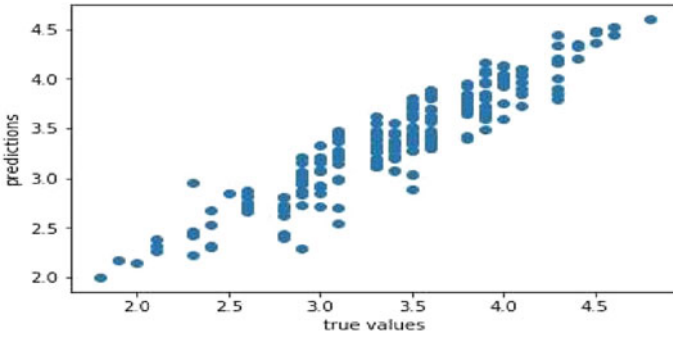

Fig. 20 Visualization of predicted and tested values of Random Forest Regression2. This model predicts the results but with less accuracy of 88.0% in comparison to Random Forest Regression1. Mean square regression loss is 0.0315995487491

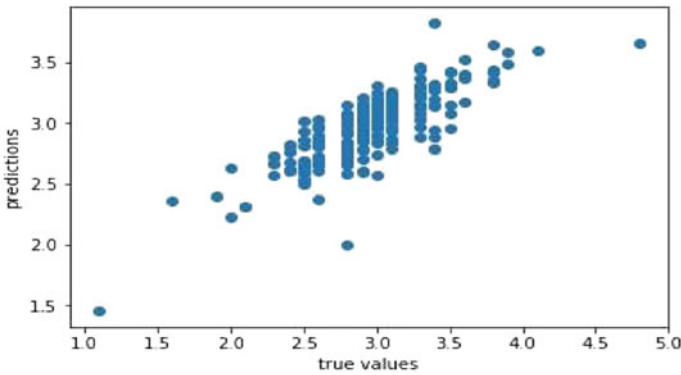

Fig. 21 Visualization of predicted and tested values of Random Forest Regression3. This is model has comparatively less accuracy to other Random Forest Regressors. Accuracy is 64.84% and mean square regression loss 0.065326862103

basis of different datasets used, different algorithms are required to be implemented accordingly. This is because the calculated root mean square error value was the minimum, i.e., 0.00156 and 0.0016.

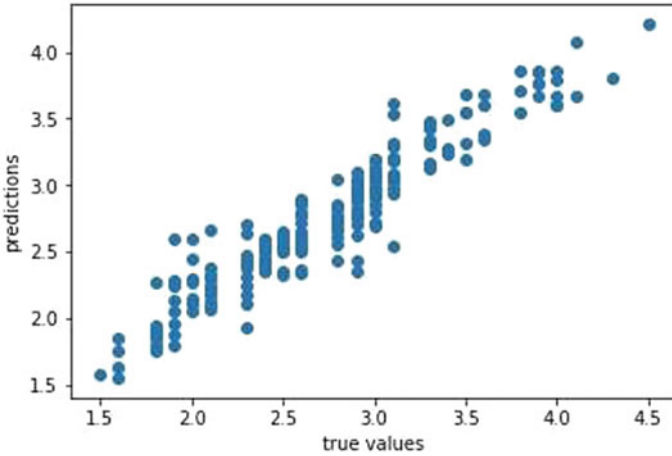

Fig. 22 Visualization of predicted and tested values of Random Forest Regression4. This model is performing predictions in same manner as Random Forest Regression2. Graph is almost the same for both the regressors. Accuracy is 89.35% and mean square regression loss 0.0385353877922

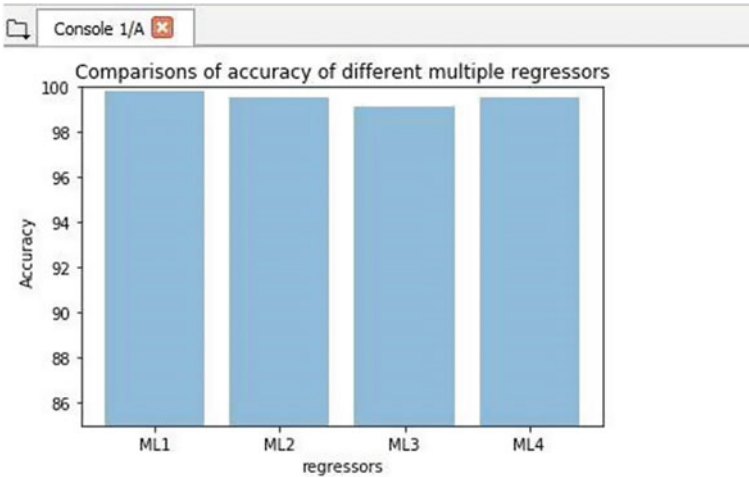

Fig. 23 Comparison of accuracy of different multiple regressions. This graph represents the comparison among the accuracies of four regressors of Multiple Linear Regression. All the regressors are computing almost the same results as there is not much difference in their accuracies. But the highest accuracy is of Multiple Linear Regression1 that is, 99.79%. Average accuracy of multiple Linear Regression is 99.5%. By this accurate result, the model is very impressive and this method compiles all the data that are collected by IOT device, and gives good result

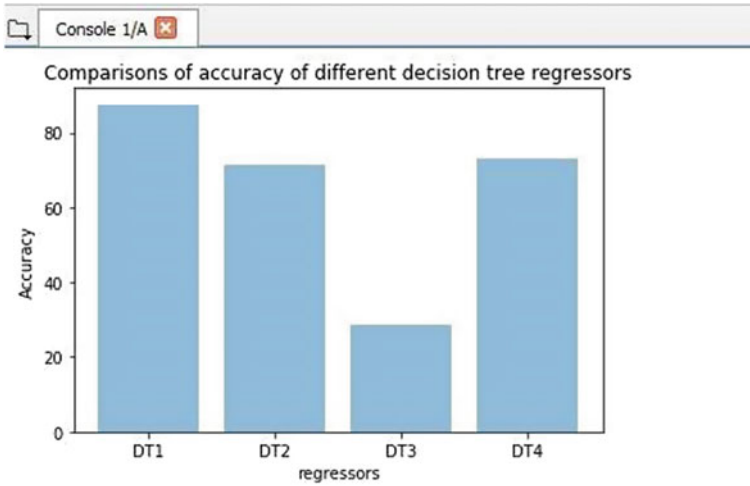

Fig. 24 Comparison of accuracy of different decision tree regressions. As it is clearly visible through the graph that Decision Tree Regression1 is having the highest accuracy that is, 87.52% greatest among all the regressors

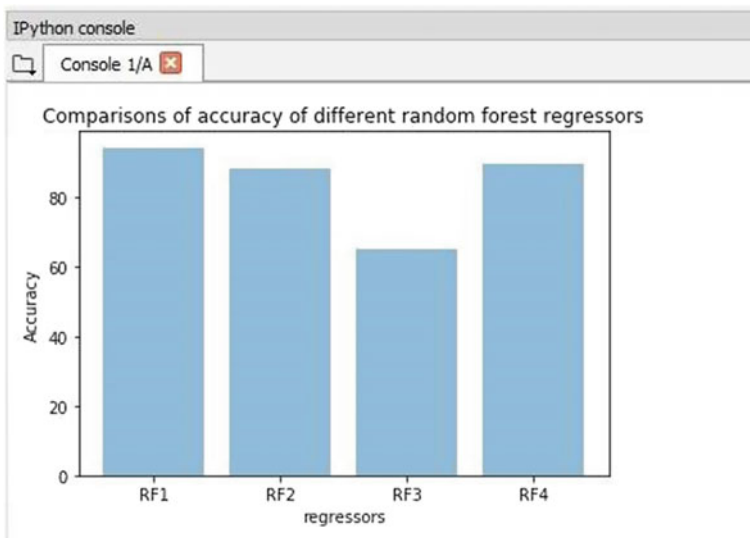

Fig. 25 Comparison of accuracy of different Random Forest Regressions. As it is clearly visible through the graph that Random Forest Regression1 is having the highest accuracy among all the regressors that is, 94.16%. Random Forest Regression2 and Random Forest Regression4 achieve almost the same accuracy but Regression3 with accuracy of 64.84%. The comparison between all the regressors that we have got in this figure using the concept of IOT. Since the data processed during regression are very large, so the compared data of different regressors are in tremendous amount which can be processed and stored using big data

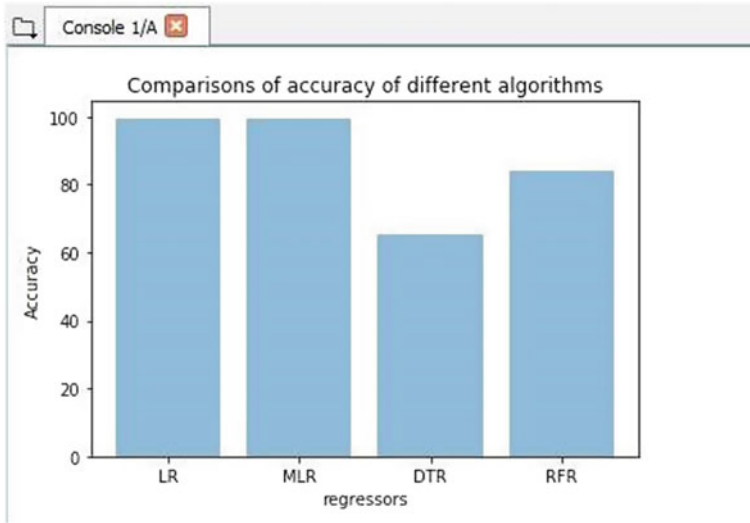

Fig. 26 Comparison Graph of Accuracies of Algorithms. This graph represents the performance of all the models in predicting the values in form of accuracy. As graph depicts that Linear Regression and Multiple Linear Regression attained almost the same accuracy. Random Forest Regression has the accuracy of 84.0875%. Least accuracy is estimated by Decision Tree Regression that is, 64.175%. Accuracy is very important because accuracy gives minimum error. Prediction of personality is accurately achieved by multiple linear regressions as it can handle the large amount of data, i.e., big data perfectly

As we can see in the graph below that decision tree regression model has achieved minimum accuracy as in comparison to others so it is not the model, which can be used for training our model for determining the personality traits of individuals. For training our model, decision tree is not efficient as more the number of decisions, less the expected value of the accuracy.

Accuracy Percentage

Linear Regression = 99.56%. Multiple Linear Regression = 99.5%.

Decision Tree Regression = 64.175%. Random Forest Regression = 84.0875%. Learned Python, work under pressure and teamwork. Among the different regression algorithms, Linear Regression and Multiple Linear Regression are best in order to perform the personality detection test. Linear Regression will be used for performing the computations as it performs prediction with 99.56% accuracy.

The framework is based on a report named “Individual differences in sense of humor and their relation with psychological well-being”. In this, the author will develop a questionnaire. These questionnaires will be used as a source for predicting the personality of an individual in terms of four personality traits (aggressive, affiliative, self-enhancing, and self-defeating). Every participant or user will have to give answers and on the basis of that answers, the range of each personality trait in the range of 0–5 will be calculated.

9 Future Directions, Novelty, and Complexity Analysis

Since the personality of an individual can adversely affect the professional attitude of a person. All the MNCs and even our defense organization select candidate for job on the basis of their personality, therefore, they use some procedure to predict the personality of an individual, which can be done through machine learning and take IOT data and model result to select the perfect candidate. This experimental study can be further modified to be used in these organizations to get more efficient prediction.

Different disciplines and backgrounds of computer science engineering with psychology have been merged to perform the work. Specifically, the author aims to predict the personality traits of an individual as the personal and professional life of an individual.

The analysis is performed on the personality detection to get the domination of some particular personality traits in male or female [19]. The prediction of personality has been done through k-nearest neighbor classification technique [20]. Personality detection is less efficient and costly manually so the author has tried to do these jobs by machine learning. Regression techniques used for the prediction are linear regression, decision tree, and random forest. An individual can use the predicted result to develop their personality and improve their personal and professional life.

The work has been done by merging mathematical algorithms and the psychology and behavior of human being. Psychologists seek to measure the personality by analyzing human behavior. This process of analyzing the human behavior can be done mathematically. The author has used the basic analysis of human behavior to prepare the questionnaire machine learning algorithms to train the model using the collected dataset. The author has converted the subjective concept into some quantitative approach. This analysis can be proved very much beneficial to improve the personality to accomplish healthy and successful life.

The personality is something, which describes your actions and reactions toward in any situations or how you will react in particular circumstances. Prediction of personality traits is not much accurate when performed manually and it is a complex process too. Using machine learning subjective work can now be performed using mathematical models. These models are trained with experiences and could easily perform a personality test, which is much more accurate and fast as in comparison to manual task.

The human behavior is very different to analyze as human mind along with human nature is very complex. So, we need some technology, i.e., IOT which may analyze the person's personality from very near. The calculated attributes are subjective and vary from person to person. Also, it is so complex phenomenon that it can be treated as NP-complete program. The run-time complexity will be high in the program as the human behavior and thinking are very complex to convert it into some quantitative calculations.

10 Recommendations, Limitations, Future Scope, and Possible Applications

The given program or method is used to predict the personality of an individual in terms of four personality traits (aggressive, affiliative, self-enhancing, and self-defeating) where we need some technology to handle the big data because all four personality traits generate abundant data. For processing and storage of data, we use data processing application software. As the personality of an individual can directly influence the social, personal, and professional life of an individual. The result of this technology helps in analyzing the personality traits of an individual and with the help of this result, the user can develop his or her personality as they will be aware of their weaknesses and strengths. IOT gives every information about the personality of a person and may predict that what will be the need of person and constantly watch their behavior, executes the data by method of multiple regression and with time IOT makes them smarter.

The method used by the authors is a new way for computing personality detection test. Machine learning is something which makes the human work easier and gives more efficient output. As it is a well-known fact that decision-making processes of human beings are easily affected by the activities and up and downs of human life. Process of personality test is automated in order to reduce the human error and it's done by IOT device, which always connects the person with Internet. This is one of the reasons that this method is much accurate and preferable in order to predict the personality of an individual because personality data is very large and by using Big Data concept processing of this type of large data has become easy and it gives an accurate result. These tests are better to understand the perception of an individual for self-reflection and understanding. The result of this technology is helpful to decide the one's personality and take important decisions in the field of job placement, group interaction, drive to learn, and team spirit.

The framework can work for short number of parameters. The personality of an individual is predicted on the basis of answers collected from the user. The questionnaire is developed on the basis of difference in someone's sense of humor and usage of humor, but there are so many factors which can influence the personality, which is determined by IOT therefore to obtain the accurate and more precise result, maximum factors should be covered during the development of questionnaire and these data are processed using big data and gives more precise result.

The model used for personality detection is Linear Regression. But Linear Regression is prone to overfitting such that regression begins to model noise in the data along with the relationship of the variables. This is pretty extrapolation and not necessarily accurate. Decision Tree Regression is not estimating the good results so we can't use this for learning and prediction of personality traits.

Explore yourself from a completely different perspective. To find a successful career and improve social and personal life by understanding different personality traits.

But this is possible when connectivity will improve, data collection will manage and differentiate for different parameter. Internet of Things will be smarter than human in the future but for protection, we need some organization to monitor all data process and identify unethical action.

Collection of data will be larger in the future so if anyone manipulates, then IOT will not show good result.

To overcome this vulnerability, we need to make some hardware and software to secure the result and behavior of modal.

Interviews in corporate, during hiring procedure and ever for selecting person in companies, for example, in agile software development methodology, it is very important to find the right person for the particular job.

Personality tests in government organizations, As the jobs like them demands different characteristics and personality of and individual for example the ORQ (officer like qualities are needed in defense some special characteristics are needed in IAS officer, that can differ from the characteristics needed for an IPS officer so in order to find right candidate the personality detection can be a great help.

Can help to the aspirants of such jobs which need good personality. And same data transfer to other company, organization or government bodies to select good candidate. So here role of big data will be increase. So, they can prepare by working on their personality as, if they will know the problem than they can easily find the solution [21].

This method can be used by the user to develop their personality. This method can be used in companies also to give appropriate work to appropriate employee according to their personality (owadays, it is used in agile methodology of software development where the attitude of an employee plays a very important role). This program can be used in selection in defense, as the main requirement in defense is attitude and personality. This program can be used by the aspirants also to prepare for particular jobs or exams.

11 Motivation

Personality is something that explains the behavior of an individual in different circumstances. If the people will be aware of their personality than they can improve their personality, if they want as if we don't know the disease than how can we find the accurate medicine to cure the disease. Not only for an individual personality can detection be used by companies to hire the right person for the right job. As each job require demands, some unique characteristics to find the person who holds them can be found by the procedure of personality detection.

Machine learning is getting popular day by day and enable the computers to perform computations without being explicitly programmed. Science has made our life simpler and proved to be boon for solving many complex problems. Many researches in personality ranges from the study of biological systems to genetic codes in order to study social, cultural basis of thought, emotions, feelings, and behavior. Issues of

personality appeal to everyone and there are many interesting web sites that can be visited both inside and outside of academia. So, this is basically an approach that can be used by any organization during the personality test conducted during the selection process of any employee. A personality test can give the different characteristics or features which were not known to us.

Today, everyone wants a better life but instead of focusing on their weakness and strength, they criticize others and system. Therefore, we need to improve ourselves, and this test can be proved useful for personality development of an individual. Interviews in corporate, during hiring procedure and ever for selecting person in companies, for example, in agile software development methodology, it is very important to find the right person for the particular job.

Personality tests in government organizations, As the jobs like them demands different characteristics and personality of and individual for example the ORQ (officer like qualities are needed in defense some special characteristics are needed in IAS officer, that can differ from the characteristics needed for an IPS officer so in order to find right candidate the personality detection can be a great help.

It can help to the aspirants of such jobs which need good personality. So, they can prepare by working on their personality as, if they will know the problem than they can easily find the solution.

12 Conclusion

The proposed work will be an effort to utilize the machine intelligent techniques like Python programming on Spyder framework. Human beings are complex to understand and their personality traits are changed according to the changes in them. So, we will try to learn more and more about them.

To predict the personality traits of an individual here, the author has implemented a method that involves the supervised learning. Supervised learning has a subset of algorithms called regressions. These regressors have provided us with the models which are trained for learning. Models learned from experiences that is, 80% of train data and the remaining 20% are used to test the accuracy of prediction. Among the four models, Linear Regression and Multiple Linear Regression have attained the best prediction accuracy of 95% about.

Decision Tree Regression has a prediction accuracy of 64.175% which is very less. So, this model can't be used for predicting the personality traits using dataset available with us. Random Forest Regression attained the accuracy of 84.0875%, which is better than Decision Tree Regression it can also be used as a secondary model to predict the personality traits.

The difference in an individual's sense of humor can influence the personality trait of an individual. Therefore, the sense of humor and usage of humor can be used to predict the personality of an individual. The personality of an individual affects their life, therefore, it is very important to develop their personality and anyone can improve their personality only when they are aware about their weakness and

strengths. So, to know the weakness and strengths of an individual can be known by analyzing the personality traits of an individual.

The proposed work is a successful mathematical framework to calculate or predict human personality traits. Which can help the user to develop their personality to achieve a healthy and successful life?

This method can be used by the user to develop their personality. This method can be used in companies also to give appropriate work to appropriate employee according to their personality (Nowadays, it is used in agile methodology of software development where the attitude of an employee plays a very important role). This program can be used in selection in defense, as the main requirement in defense is attitude and personality. This program can be used by the aspirants also to prepare for particular jobs or exams.

Acknowledgements The authors are obliged for the guidance of ABES Engineering College staffs and faculties. Mr. Shubham Sidana, Mr. Abhishek Goyal, Mr. Mayank Gupta of TCS, and evaluation team of experimental presentation to understand the concept well and for showing the path ahead. The acknowledgement is to all those forces which inspired us to work hard and to learn something and to make a difference in society.

References

1. A. Kumari, S. Tanwar, S. Tyagi, N. Kumar, Fog computing for healthcare 4.0 environment: opportunities and challenges. *Comput. Electr. Eng.* **72**, 1–13 (2018)
2. A. Kumari, S. Tanwar, S. Tyagi, N. Kumar, M. Maasberg, K.K.R. Choo, Multimedia big data computing and Internet of Things applications: a taxonomy and process model. *J. Netw. Comput. Appl.* **124**, 169–195 (2018)
3. K.H.K. Reddy, H. Das, D.S. Roy, *A Data Aware Scheme for Scheduling Big-Data Applications with SAVANNA Hadoop*. Futures of Network (CRC Press, 2017)
4. H. Das, A.K. Jena, P.K. Rath, B. Muduli, S.R. Das, Grid computing-based performance analysis of power system: a graph theoretic approach, in *Intelligent Computing, Communication and Devices* (Springer, New Delhi, 2015), pp. 259–266
5. B.B. Mishra, S. Dehuri, B.K. Panigrahi, A.K. Nayak, B.S.P. Mishra, H. Das, *Computational Intelligence in Sensor Networks*. Studies in Computational Intelligence, vol. 776 (Springer, 2018)
6. S. Tanwar, P. Patel, K. Patel, S. Tyagi, N. Kumar, M.S. Obaidat, An advanced internet of thing based security alert system for smart home, in *International Conference on Computer, Information and Telecommunication Systems (IEEE CITS-2017)*, Dalian University, Dalian, China, 21–23 July 2017, pp. 25–29
7. A. Srivastava, S.K. Singh, S. Tanwar, S. Tyagi, Suitability of big data analytics in indian banking sector to increase revenue and profitability, in *3rd International Conference on Advances in Computing, Communication & Automation (ICACCA-2017)*, Tula Institute, Dehradun, UK, pp. 1–6
8. I. Kar, R.R. Parida, H. Das, Energy aware scheduling using genetic algorithm in cloud data centers, in *International Conference on Electrical, Electronics, and Optimization Techniques (ICEEOT)*, March 2016 (IEEE, 2016), pp. 3545–3550
9. J. Villena-Roman, J. Garcia-Morera, C. Moreno-Garcia, L. Ferrer-Urefia, S. Lana-Serrano, J. Carlos Gonzalez-Cristobal, A. Waterski, E. Martinez-Camara, M.A. Umbreras, N1.T. Martin-Valdivia, L. Alfonso Urefia-Lopez, *TASS-Workshop on Sentiment Analysis at SEPLN, Workshop on Sentiment Analysis*. Sociedad Espanola para el Procesamiento del Lenguaje (2012)

10. M. De Juan-Espinosa, *Personalidad Artificial: Hacia Una Simulación De Las Diferencias De Personalidad En Situaciones De Interacción* (Universidad Autónoma de Madrid, Madrid, 2007)
11. A. Bandura, R.H. Walters, A. Riviere, *Aprendizaje social y desarrollo de la personalidad*. Alianza Editorial Sa (2007)
12. N.D. Liver good, *Strategic Personality Simulation: A New Strategic Concept*. Center for Strategic Leadership, US Army War College, vol. 3 (1995), pp. 60–93
13. L.J. Francis, L.B. Brown, R. Philipchalk, The development of an abbreviated form of the Revised Eysenck Personality Questionnaire (EPQR-A): its use among students in England, Canada, the USA and Australia. *Pers. Individ. Differ.* **13**(4), 443–449 (1992)
14. G. Young, Mapping mayhem: the geography of crime. *Computer Age*. Google Scholar **171**(107) (2003)
15. D.K. Rossmo, *Geographic Profiling*, vol. 1 (CRC Press, 1999). ISBN-0849381290
16. P. Sarkhel, H. Das, L.K. Vashishtha, Task-scheduling algorithms in cloud environment, in *Computational Intelligence in Data Mining* (Springer, Singapore, 2017), pp. 553–562
17. H. Das, A.K. Jena, J. Nayak, B. Naik, H.S. Behera, A novel PSO based back propagation learning-MLP (PSO-BP-MLP) for classification, in *Computational Intelligence in Data Mining*, vol. 2 (Springer, New Delhi, 2015), pp. 461–471
18. T. Polzehl, S. Möller, F. Metzke, Automatically assessing acoustic manifestations of personality in speech, in *Spoken Language Technology Workshop (SLT)*, December 2010 (IEEE, 2010), pp. 7–12
19. L.R. Goldberg, Language and individual differences: the search for universals in personality lexicons. *Rev. Pers. Soc. Psychol.* **2**(1), 141–165 (2007)
20. A.V. Ivanov, G. Riccardi, A.J. Sporka, J. Franc, Recognition of personality traits from human spoken conversations, in *Twelfth Annual Conference of the International Speech Communication Association* (2011)
21. A.J. Gill, J. Oberlander, Taking care of the linguistic features of extraversion, in *Proceedings of the Annual Meeting of the Cognitive Science Society*, vol. 24, no. 24, January 2002
22. M. De Juan, *Personalidad y Criminalidad*, Apuntes de Psicología Criminológica. la asignatura Psicología Criminológica, Universidad Autónoma de Madrid (No publicado) (2005)
23. P.T. Costa, R.R. McCrea, *Revised neo personality inventory (NEO PI-R) and neo five-factor inventory (NEO-FFI)* (Psychological Assessment Resources, 2012)
24. H.J. Eysenek, H.J. Eysenck, *Dimensions of Personality*, vol. 5 (Transaction Publishers, 1950), pp. 398–423
25. F. Mairesse, M. Walker, Automatic recognition of personality in conversation, in *Proceedings of the Human Language Technology Conference of the NAACL, Companion Volume: Short Papers. Association for Computational Linguistics*, June 2006, pp. 85–88
26. J.W.P.M.E. Francis, R.J. Booth, *Linguistic Inquiry and Word Count*. Technical Report (Southern Methodist University, Dallas, TX, 1993)
27. A. Ruiz-Falcó, Instituto de Astrofísica de Andalucía, CSIC. Entiempo real Lenguajes de Descripción Hardware: Conceptos y Perspectivas (126), 35 (2009)
28. G.V. Caprara, C. Barbaranelli, L. Borgogni, M. Perugini, The “Big Five Questionnaire”: a new questionnaire to assess the five-factor model. *Pers. Individ. Differ.* **15**(3), 281–288 (2011)

Data Reduction in MMBD Computing



Yosef Hasan Jbara

Abstract Internet of Things technology is emerging very quickly in human facilities of all types, such as smart home and industry, which leads to a large boom in multimedia big data due to the connection of approximately 50 billion devices to the internet in 2020. It is really a challenging task to manage the IoT multimedia data regarding storage and transmission. The only way to handle this complicated storage and transmission problem is the process of compression techniques. Multimedia data is compressed by reducing its redundancy. Compression algorithms face numerous difficulties because of the large size, high streaming rate, and the high quality of the data, due to their different types and modality of acquisition. This chapter provides an overarching view of data compression challenges related to big data and IoT environment. In this chapter, we provide an overview of the various data compression techniques employed for multimedia big data computing, such as run-length coding, Huffman coding, arithmetic coding, delta modulation, discrete cosine transform, fast Fourier transform, joint photograph expert group, moving picture expert group, and H.261, including the essential theory, the taxonomy, necessary algorithmic details, mathematical foundations, and their relative benefits and disadvantages.

Keywords Internet of Things · Multimedia big data · JPEG · MPEG · Quality of service · CODEC

1 Introduction

The Internet of Things (IoT) will induce a vast influx of big data as a result of the massive spreading of sensors across almost every industry. The emerging popularity of IoT-based Internet-friendly low-cost devices and the explosive use of smart device technology, drive users to generate and transmit multimedia data over the internet.

Y. H. Jbara (✉)

Computer Science, College of Engineering and Information Technology,
Buraydha Colleges, Al Qassim, Saudi Arabia
e-mail: yosefjbara@ieee.org

© Springer Nature Singapore Pte Ltd. 2020
S. Tanwar et al. (eds.), *Multimedia Big Data Computing*
for IoT Applications, Intelligent Systems Reference Library 163,
https://doi.org/10.1007/978-981-13-8759-3_8

217

IoT-enabled devices and objects upload tremendous amounts of audio, image, video, and text data in real time [1]. In 2012, the number of radio-frequency identification (RFID) tags and IoT-enabled devices in commercial use was 12 million. This quantity is predicted to increase to 210 billion in 2021. The multimedia data from IoT-enabled devices belong to big data sets, and this information is typically gathered for analysis and control. The total turnover of the multimedia big data business was 10.2 billion dollars in 2011. It grew to 54.3 billion dollars in 2017. There will be a boom in multimedia big data due to the connection of approximately 50 billion users to the internet in 2020. Therefore, the two technologies IoT and multimedia big data are growing in parallel. IoT is a network of smart devices that collect and exchange data. It has been estimated that trillions of the data will be created every hour by 31 billion devices in 2020 and 76 billion in 2025 [2].

The substantial amount of multimedia content that is obtainable among IoT components contains enormous amounts of text, audio, image, video, and animation data. These data originate from entry-level IoT products such as Amazon Dash Buttons to virtual reality (VR) and augmented reality (AR) IoT devices such as Samsung Gear VR [3]. In this big data era, multimedia data have become a unique type of big data because of the colossal generation of multimedia datasets and their subsequent storage, transmission and processing.

The traditional multimedia compression techniques face challenges because of the characteristics, namely, massive volume and complex structure, of IoT data sets [4]. Multimedia big data are any combination of large-scale signals such as text, graphics, art, sound, and video elements, which all are partially unknown complex structures in nature. All these multimedia component signals have a skeletal resemblance and are described in terms of a statistical parameter in time and space, drift curvature, redundancies, and the quality of experience. Naturally, the modeling and representation of such unstructured, multimodal and heterogeneous multimedia big data are complicated processes.

The processing steps of the life cycle of multimedia big data are acquisition, compression, storage, processing, interpretation, assessment, and security. Initially, the big data are acquired from IoT-enabled devices. Before further storage and processing, the data are compressed and interpreted. The data transfer is subject to security checks, and the assessment is carried out with acquired data and credible data. These multimedia big data are compressed to ensure efficient storage and communication, as their vast volume exceeds the capacity of the transmission channel and the storage capacities of computing machines. Moreover, multimedia big data face challenges in achieving fast storage and processing due to their large data volumes [5].

Multimedia data reduction results in two main benefits: reduced memory size in the local disk and increased speed of data transfer between the network and the disk. Multimedia big data face substantial problems, after acquisition from sensors, RFIDs, and interconnected smart devices in storage and processing. Therefore, the compression of multimedia big data is an inevitable process in IoT applications [6]. The initially acquired data require an effective compression algorithm that uses time domain or frequency domain methods, to overcome the limitations of the traditional memory and computational resources. Such compression algorithms face numerous

difficulties that are due to the enormous size, faster streaming rate, quality, and various types and modalities of acquisition of the data. The very fast multimedia big data reduction techniques must be employed, to manage the large data volume [7].

In a multimedia data reduction technique, an encoding process is applied to represent that data using fewer bits by utilizing a precise encoding system. Storage, throughput, and interaction are the fundamental coding requirements for data reduction techniques. The multimedia data reduction techniques are of high significance in IoT because of the reduction in disk space for storage, which enhances reading and writing. The speed of file transfer is also increased with variable dynamic range and byte order independence via these reduction techniques [8]. Additional disk space will be needed to store multimedia components such as images and graphics, audio, videos, and animations. We require 175 kB of memory space to save audio that has been recorded for one second in stereo quality. A $320 \times 240 \times 8$ -bit grayscale image requires 77 kB memory space, a $1100 \times 900 \times 24$ -bit color image requires 3 MB disk space, and a $640 \times 480 \times 24 \times 30$ frames/s video requires 27.6 MB/s of memory. The interaction between the sender and receiver should be very fast to avoid transmission delays in the multimedia system [9].

Compression methods are broadly classified into lossless and lossy methods. In a lossless compression technique, the original data are completely recovered from the compressed data. Every bit of the original data is recovered from the compressed data. A lossy compression technique reduces the acceptable level of data in the coding process and rebuilds an estimation of the original data in decoding [10].

The fundamental categories of multimedia data reduction techniques are entropy coding, source coding, channel coding, and hybrid coding. Methods in the entropy coding category use run-length coding, Huffman coding, and arithmetic coding. DPCM and DM are the most widely used prediction techniques in source coding. Prior to the encoding, the original multimedia data are transformed into a compact data format to realize more effective coding by employing fast Fourier transform (FFT) and discrete cosine transform (DCT) transformations [11]. The most widely used compression models under the hybrid coding category, are Joint Photographic Experts Group (JPEG), Moving Picture expert group (MPEG), and H.261, which are utilized for the compression of multimedia such as text, graphics, art, sound, and video.

The run-length coding technique replaces each repeated value by the length of its run and its value based on entropy. Compression is realized by eliminating the redundancy that is due to the continuous occurrence of the same value [12]. The Huffman coding algorithm uses the shortest code for the most frequently occurring values and the longest code for the least frequently occurring values based on entropy. Compression is realized by using variable bit lengths for different values.

In arithmetic coding allows “blending” of bits in a data stream are “blended” and the total number of required bits is calculated based on the sum of the self-information using a message interval and a sequence interval. In the differential coding algorithm, the difference between two continuous data values is encoded instead of the data [13]. In vector quantization, the original data are split into chunks of bytes. Then, each chunk is encoded with a list of patterns. Lempel–Ziv–Welch (LZW) compression

uses a code table with 4096 data patterns. If the input data are matched with an entry in the table, the corresponding data are replaced with that matched pattern.

JPEG is the first lossy monochrome and color image compression norm and was developed by the Joint Photographic Experts Group. The functional systems of JPEG are the baseline system, an extended system, and a special lossless function. The first level, namely, the baseline system, decompresses color images to realize the required level of compression. Various encoding techniques, such as variable-length encoding, progressive encoding, and hierarchical mode encoding are processed in the second level of the JPEG extended system [14]. In the last level, the special lossless function guarantees the resolution of the multimedia data, which ensures that there is an exact match between the compressed and original images.

The four phases of the JPEG compression process are preparation, processing, quantization, and entropy encoding. In the preparation phase, color space conversion is performed. The color image is converted into Y, C_b, C_r from RGB format. The processing stage divides the luminance and chrominance information into 8×8 square blocks and applies a 2D DCT to each block, which removes the preliminary data redundancy. The DCT translates the multimedia data of each 8×8 block from spatial information into an efficient frequency space representation that is better suited for compression.

In this stage, quantization is applied on 8×8 DCT coefficients by discarding the grayscale and color information. The quantization process reduces the DCT coefficients that correspond to less than the value of the basis function to zero. Now, the DCT array contains more zeros, which leads to sufficient compression in the final stage. In the final entropy coding stage, quantized DCT coefficients are organized and arranged in a “zigzag” pattern. Then, the run-length encoding algorithm is employed on similar frequency groups and the inserted length coding zeros. The remaining pixels are encoded using Huffman coding.

MPEG, which stands for Moving Picture Expert Group, is an international standard for both audio and video compression. It decreases the required storage and space bandwidth via means of both encoding and decoding processes [15]. The standards are MPEG 1, MPEG 2, and MPEG 4, which differ in terms of the video resolution, the frame rate, and the bit rate. MPEG 1 supports source input format (SIF) videos, with resolutions of 352×288 pixels at 25 frames/s for the Phase Alternating Line (PAL) system and 352×240 pixels at 30 frames/s for the National Television Systems Committee (NTSC) system and a bit rate of 1.5 Mb/s. The maximum target bit rate of MPEG-2 is between 4 and 9 Mb/s, with 720×480 -pixel resolution video at 30 frames/s [16]. In MPEG, video is divided into macroblocks via a video sequence layer, a grouping layer, and a slice layer. Each macroblock consists of 16×16 arrays of luminance pixels and two 8×8 arrays of associated chrominance pixels. The macro blocks are further divided into distinct 8×8 blocks and transform coding is applied on each block. The remaining processes are the same as in JPEG.

This chapter is prepared to deliver complete details of the various categories of compression methods, by including a full and useful nomenclature, a detailed investigation in terms of architecture, advantages, and shortcomings and collective practices. We also delve into the most significant impact of the compression of

multimedia big data, with an excellent and lucid review of the current multimedia IoT data compression techniques. So we hope this chapter be able to help as a valuable reference for teachers and researcher involved in IoT data compression and processing, which has remarkable openings in both education and employment. This chapter also delivers an instrumental allusion for IoT, multimedia professionals, and computer scientists. We organized this chapter with five key sections broadly including all features of multimedia data compression: Multimedia basics, Elements, and File Formats, Quality of Service, Principles of Compression Techniques, and Image Compression Standards. In this chapter, we discuss the most significant impact of the compression of multimedia big data. We hope this chapter will serve as a valuable reference for teachers and researchers who are involved in IoT data compression and processing, which have remarkable applications in both education and research.

The remainder of this chapter is organized into four sections: In Sect. 2, we describe the multimedia elements, the preliminaries of differential formats and quality of service. Section 3 reviews several multimedia compression techniques and their principles. We discuss critical open problems in reference models and protocols and recent developments along with future directions in Sect. 4. Lastly, Sect. 5 concludes this chapter with an encapsulated summary of data reduction in multimedia big data computing.

2 Multimedia Basics

The advancement of IoT has had a large impact on multimedia data. Multimedia is an interactive form of communication in which multiple types of media data such as text, audio, graphics, animation, and video, are conveyed. In recent years, with significant advances in the state-of-the-art semantic web techniques and technologies, IoT has explored a tremendous amount of multimedia big data [17].

According to a recent survey by Cisco and IBM, every day, IoT-enabled devices, such as smart consumer appliances and lab instruments, will generate 2560 quintillion data (1 quintillion = 10^{17}). They also predicted that this amount of IoT multimedia data will increase to 40 yottabytes in 2020 (1 yottabyte = 10^{24} bytes) and every person will generate 5200 GB per day in the IoT era. Because of this extremely large volume and the intangible nature of fundamental data formats, IoT multimedia will encounter substantial problems in storage and transmission. Therefore, it is essential to understand exclusively the basics of multimedia big data and to have the in-depth knowledge of the file formats and the quality of service of multimedia big data systems [18]. To handle multimedia data, three fundamental requirements must be specified for compression, namely, the video frame size, frame rate, and synchronization of audio and video, along with the encoding and decoding speeds, end-to-end delay and data retrieval rate.

The data that are collected and exchanged between smart devices are multimedia data, which are a complex mixture of audio, video, text, image, and animation. It is challenging to handle this vast amount of data. Big data techniques are used to

manage the large data that have been obtained from IoT devices and other sources. Since big data are large and complex, it is challenging to store and retrieve the rapidly increasing volume of multimedia data from smart devices.

For multimedia big data, substantial problems are encountered after acquisition from sensors, RFIDs, and interconnected smart devices in storage and processing. Thus, the compression of multimedia big data is an inevitable process in IoT applications. The initially acquired data require an effective compression algorithm that uses time domain or frequency domain methods, to overcome the limitations in the traditional memory and computational resources. These compression algorithms face numerous difficulties because of the enormous size, high streaming rate and high quality of the data, which results from the various types and modalities of acquisition.

The challenging task of storing multimedia data is performed by utilizing one of the most critical signal processing techniques: data compression. Data compression is a complex process that involves sequences of several operations. An encoding operation with an appropriate representation technique removes the redundancy in the data set, which results in an overall reduction in the size of data. However, multimedia compression uses various types of tools and procedures to decrease the file sizes for text, audio, image, video and animation formats. In turn, multimedia compression reduces the amount of memory that is necessary for storing media files and reduces the amount of bandwidth that is required for the transmission of media files.

2.1 Elements and File Formats

Multimedia is a complex type of data, with a combination of audio, animation, graphics, image, text, and video data. Any IoT application consists of any or all the multimedia elements.

This section discusses the most important data types that are used in multimedia big data in IoT applications. This basic information provides the reader with the necessary background knowledge for understanding the compression techniques and standards of this big data era.

2.1.1 Text

Text and symbols are fundamental data that are important for communication in any medium. The forms of text information include ASCII/Unicode, HTML, Postscript, and PDF. The standard file type for text only is TXT and those for text with other elements are DOC, DOCX, and PDF [19].

2.1.2 Graphics and Images

These are important data elements in IoT multimedia big data computation. The main sources for image data in IoT are digital still cameras and video cameras. All computers and software compatibly support available file formats such as GIF (Graphics Interchange Format), TIFF (Tagged Image File Format), JPEG (Joint Photographic Experts Groups), EPS (Encapsulated PostScript), BMP (Bitmap Image File), PNG (Portable Network Graphics), and RAW [20]. In this section, we present introductory information of various image and graphics file formats.

TIFF was developed by Aldus and is best-suited for high-quality prints, professional publications, and archival copies. This TIFF file format requires a large memory space for storage because of its large size. An image that is in this format can be stored in bi-level (black and white), grayscale, palette (indexed), or RGB (true color). Compression is optional for TIFF images. Huffman and LZW algorithms are used for compression. After compression, the file is larger compared to GIF and JPEG files. TIFF images can be displayed by web browsers using inbuilt plug-ins [21].

Microsoft developed the BMP image file format for their Windows operating system. Like TIFF, BMP images are of high quality, with or without compression but require more memory space for storage. This file format is device-independent and can be displayed by any display by Windows operating systems. The bitmap file format supports monochrome, 16-color, 256-color, and 224-color images. The default file extension is .bmp [22].

JPEG is a standardized image compression mechanism. It was devised by the Joint Photographic Experts Group for compressing either full-color or grayscale images via a lossy encoding technique. It performs well with photographs and artwork. The size of the image file is small because it stores 24-bit-per-pixel color data instead of 8-bit. In the last entropy coding stage, quantized DCT coefficients are arranged in a “zigzag” pattern. A run-length encoding algorithm is employed on similar frequency groups and inserted length coding zeros. The remaining pixels are encoded using Huffman coding. It can easily realize a 20:1 compression ratio [23].

GIF is a standard file format that was developed by CompuServ for the storage and transmission of color raster image information. Since it uses lossy compression encoding techniques, the resulting files are small and portable. It can also be used to store screenshots, letters, geometric line drawings, sharp images, and flat color images. It enables the display of high-quality, high-resolution graphics on any display using graphics hardware. It has unique features such as animation and transparency. The file extension is .gif.

The PNG image format was developed by Unisys as an alternative to the GIF format for storing monochrome images with a color depth of 16-bits per pixel, color images with a color depth of 48-bits per pixel and indexed images with a palette of 256 colors [24]. Royalties should be paid to the proprietor Unisys by the user. Its compression ratio exceeds that of GIF by 5–25%. It has gamma correction and error correction mechanisms, which lead to device independence and integrity. The file extension is .png.

The EPS file extension is used for the Encapsulated PostScript image file type, which is a vector file model. It was developed for software applications such as CORELDRAW. Since this image file format contains vector information, no compression technique can be used. Its file extension is .eps.

The RAW file format represents unprocessed “raw” pixels with the intensity values and spatial coordinates of the pixels, which is the same as film negative, but in digital form. This “raw” pixel information is obtained directly from image acquisition devices such as video camera sensors. In this raw image file, each pixel is associated with an RGB intensity value. These RGB values undergo a demosaicking process. Modern digital cameras convert this raw file into a JPEG or TIFF file via proper software processes and store it in the memory card. This image file format is most suitable for photography without compression. The file extensions are .raw, .cr2, and .orf [25].

2.1.3 Audio

Audio can enrich information and strengthen concepts that are presented in the form of graphics or text. The contents of the presentation will be more informative because of the associated audio files [26]. The audio formats that are available for multimedia communication are MP3, WAV, WMA, MIDI, RealAudio, AAC, OGG, and MP4.

MIDI stands for Musical Instrument Digital Interface, which is a software interface between electronic musical instruments and a personal computer through the sound card. Like other audio file formats, MIDI files contain not only sound information but also digital notes and are suitable for playing via electronics. This file format is efficiently handled by both music hardware and computers, but not supported by internet web browsers. The file extension is midi.

Real Media devised an audio file format, namely, RealAudio, that enables the streaming of audio with the file extension.ram or.rm. Unfortunately, web browsers are unable to handle this file type.

Microsoft developed WMA (Windows Media Audio) exclusively for music players. It is suitable for Windows computers, but not web browsers. The file extension is .wma.

Similarly, Apple developed an audio file format, namely, Advanced Audio Coding, for iTunes. It is suitable for Apple computers, but not web browsers. The file extension is .acc.

The file format OGG is only supported by HTML5 and has file extension .ogg. The Xiph.Org Foundation, combined with HTML5, developed this file format.

The famous audio format MP3 is an integral part of the MPEG file format. All music players can access this audio file format effectively. A file of this format has a high compression ratio and high quality and is supported by all browsers. The file extension is .mp3. MP4 is used for both audio and video files and has the extension .mp4.

2.1.4 Video

Videos are widely used to carry information, but require high bandwidth for downloading. Video file formats combine a container file and a codec file. The container file contains bearing all the information about the file structure, along with the type of codec that is being used. The codec contains the entire procedure for coding and decoding the video data. The more common types of container formats that are available in the market are MPEG, MPEG4, AVI, WMV, QuickTime, Real Video, Flash, and WebM [27]; these formats are briefly described below to facilitate understanding of the IoT multimedia compression techniques and standards that are described in the next section.

MPEG, which stands for Moving Picture Expert Group, is an international standard for both audio and video compression, which is used to create downloadable movies. It supports all web browsers, but not HTML5. It requires less storage and bandwidth due to its encoding and decoding processes. The standards are MPEG 1, MPEG 2, and MPEG 4, which differ in terms of video resolution, frame rate, and bit rate. MPEG 1 supports SIF video, has resolutions of 352×240 pixels at 30 frames/s for the NTSC system and 352×288 pixels at 25 frames/s for the PAL system and a bit rate of 1.5 Mb/s. The maximum target bit rate of MPEG-2 is between 4 and 9 Mb/s, with a video resolution of 720×480 at 30 frames/s. It is compatible with both the Apple QuickTime Player and the Microsoft Windows Media Player. The file extension is .mpg or .mpeg. MPEG-4 is specially designed to handle movies in TV and video cameras. It can easily upload audio and video streams online. Moreover, it also supports HTML 5 and YouTube users. In this format, video and audio compression is achieved via MPEG-4 video encoding and Advance Audio Coding. The file extension is .mp4.

The Video Interleave audio format was developed by Microsoft for electronic devices gadgets such as TVs and video cameras. It performs efficiently on Widows-based PCs but is not supported by internet browsers. It stores audio and video data after encoding with different codecs and less compression. Therefore, it is widely used by internet users. It supports all players, including the Apple QuickTime Player, Microsoft Windows Media Player, VideoLAN VLC media player and Null soft Winam on both Windows and Mac platforms. The file extension is .avi.

Microsoft also developed another video file format, namely, Windows Media Video, which has the file extension .wmv for internet streaming applications. Since electronic devices such as TV and video cameras are also compatible with the Windows Media Video file format, videos are stored in this format. It also performs efficiently in Windows-based PCs but is not supported by Internet browsers. After the installation of a plug-in, Mac and UNIX-based computers can also play this format [28].

The ASF file format was developed by Microsoft for synchronized streaming videos. It is available as a container file that consists of WMA (Windows Media Audio) and WMV (Windows Media Video) with copyrights. It is also available with many other codecs. It supports still image, text, and metadata. The OS-independent

version is used to deliver multimedia across various protocols. Its file extension is .asf, which stands for Advanced Streaming Format.

QuickTime is a multimedia technology that was developed by Apple Computer for producing graphics, sound, and movies. It is also used to store such multimedia content. It has been developed for wide use on both Mac and PC. It is rarely used on the internet. The file extension is .mov.

The Real Media developed the RealVideo video file format for the internet. It allows low bandwidth video stream on the internet with a reduced amount of quality. Web browsers can't use this file format. The file extension is .ram. The RealNetworks created another video file format named RealMedia. To stream the media file over the internet with audio and video content, RealMedia file format is used. RealMedia is supported by both Mac and Pcs media players with the file extension .rm.

Flash video format is compact, complex and very common in all browsers. Macromedia has the ownership of this file format. Flash video format works well and good in Pcs, Mac, and UNIX platforms. Because of its cross-platform usage, it reaches all users progressively. It supports both progressive and streaming downloads with compression. The file extension is .flv.

Macromedia developed the Flash movie format with the inclusion of text, graphics, and animation. It needs flash plug-in to play in web browsers. So, all the latest web browsers are preinstalled with this flash plug-in. The file extension is .swf.

The 3GP format is exclusively designed to transfer both audio and video data files among 3G mobile and the internet. In most of the smartphone acquire videos and transfer in online using this file format. It is accessible by the "Apple QuickTime Player, Real Networks Real Player, Video LAN VLC media player, M Player MIK-SOFT, and Mobile 3GP Converter", both in mac and windows operating systems. The file extension is .3gp.

The browser developers "Mozilla, Opera, Adobe, and Google" devised the video file format named WebM to support HTML5. The file extension is .webm. Theora Ogg is HTML-5 supported file format and Xiph.Org Foundation is the owner of this file format. The file extension is .ogg.

2.1.5 Animation

Animation is an illustrative concept of moving graphics. The animation effect depends on the characteristics of the graphic that is used for the animation. Various tools, such as Authorware, Dreamweaver, Director, and Flash are used to generate animations. Flash can animate bitmap graphics and vector graphics; vector animation files are smaller than bitmap animation files. Open-source tools such as pencil and blender are also used to create simple 2D animations [29].

2.2 QoS—Quality of Service

An essential metric in multimedia networks, real-time multimedia systems, and distributed multimedia is quality of Service (QoS). QoS may be dynamic and its purpose is to provide an acceptable level of system performance assurance. QoS may be established for two general aspects: services and traffic. It is essential to set the QoS level for the system and require the same QoS level for traffic. The capacity of a multimedia network is measured according to the level of the guarantee for satisfying the requirements of service and traffic [30].

The variation in the QoS parameter over time complicates the maintenance of QoS in distributed multimedia systems. Therefore, we have to monitor the QoS level continuously and maintain the required QoS level by blocking lower priority tasks when necessary.

The two types of QoS are currently available in multimedia big data systems and networks: resource reservation QoS (service) and prioritization QoS (traffic). The objective of service QoS is to allocate system resources according to the network's bandwidth management policy. The traffic QoS assigns system resources according to the broadcast requirements. Since these QoS types are opposite in nature, any multimedia system must be designed to use these two QoS types in a coordinated manner to satisfy the network requirements.

The main application functionalities of a multimedia data system are common consumer gratification and correct demonstration of the hypermedia artifact to the user. Starting audio 5 s after video and synchronizing rolling text and a voice-over are examples of application functionalities. QoS depends on both the application and the network and is subject to negotiation between system components. A video game and a web page differ in terms of QoS factors, even though they are both multimedia applications.

The five categories of distributed multimedia QoS parameters are oriented in terms of performance, format, synchronization, cost, and user. The end-to-end delay, bit rate, and jitter are the QoS parameter for performance-oriented category. The format-oriented QoS parameters are the video resolution, frame rate, and storage format. The skew between the beginnings of sequences is the synchronization-oriented QoS parameter. The QoS connection and data transmission charge parameter belong to the cost-oriented category. The QoS parameters that describe the image and sound quality are user-oriented QoS parameters. The relative significance of these five parameter types depends heavily on the multimedia application to be distributed. The significance of the end-to-end delay differs between noninteractive applications such as “presentation” and interactive applications such as “conversational”.

QoS factor processing involves the following three linked operations in a multimedia distributed system:

1. Evaluating the QoS factor that corresponds to customer satisfaction with the execution performance.
2. Relating QoS factors with the evaluation of system outcomes.
3. Modifying system components to satisfy individual requirements.

3 Principles of Compression Techniques

The fundamental categories of data compression techniques are entropy coding, source coding, channel coding, and hybrid coding. The main principle of entropy coding is to ignore the semantics of the data, which falls under the category of lossless compression. Source coding is a lossy compression technique that compresses the data based on the semantics of the information. In the communication channel, we adapted the channel coding, which introduced redundancy during encoding. Hybrid coding combines entropy and source coding. Each category of compression has a technique for data reduction. The three techniques of entropy coding are run-length coding, Huffman coding, and arithmetic coding. Source coding uses two types of prediction technique: DPCM and DM; two types of transformation techniques: FFT and DCT; and three types of coding techniques: bit position, subsampling, and subband coding. Vector quantization is another technique in source coding. JPEG, MPEG, and H.261 are coding techniques in the hybrid coding category of compression [31].

3.1 Run-Length Coding

Run-length coding is suitable if a data stream has a long sequence of identical symbols, such as “ABCEEEEEEDACBBBB”. Figure 1 illustrates the algorithm for RLE.

Fig. 1 Run-length encoding algorithm

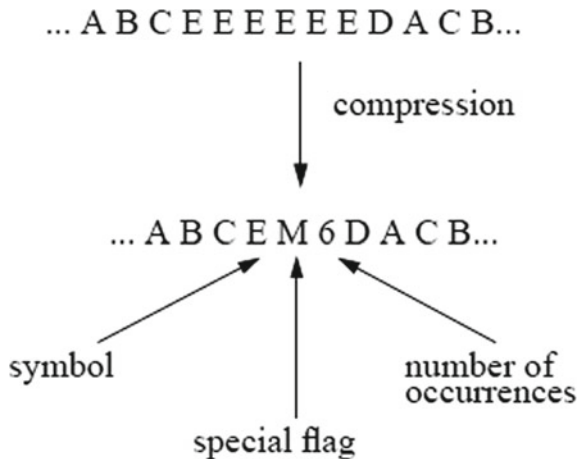

3.2 Huffman Coding

Huffman coding is most suitable for compression if the data stream has more occurrences of some symbols than others, as in the example that is shown in Fig. 2. The fundamental principle is to encode the repeatedly occurring symbols with codes of shorter length. Figure 2 shows the encoding procedure for Huffman coding. The resultant coded output is 111001101000.

3.3 Adaptive Huffman Coding

The main limitation of Huffman coding is its dependence on the statistical knowledge of the data. Since statistical knowledge is not available for live video and audio, adaptive Huffman coding is better suited for compressing live data. The adaptive Huffman encoding and decoding algorithm is shown in Fig. 3.

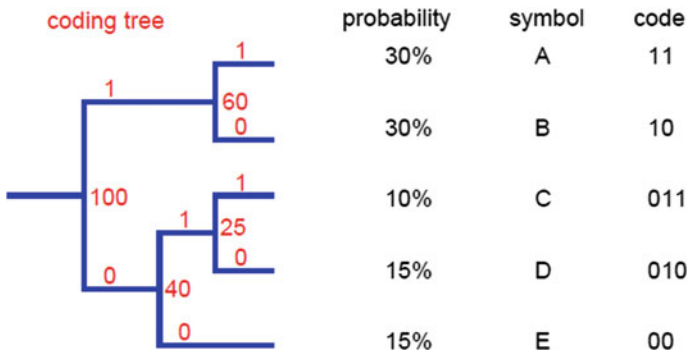

Fig. 2 Huffman encoding procedure

<p>ENCODER</p> <pre>Initialize_model(); do { c = getc(input); encode(c, output); update_model(c); } while (c != eof)</pre>	<p>DECODER</p> <pre>Initialize_model(); while (c = decode(input)) != eof) { putc(c, output) update_model(c); }</pre>
--	--

The key is that, both encoder and decoder use exactly the same *initialize_model* and *update_model* routines.

Fig. 3 Adaptive Huffman encoding and decoding algorithm

3.4 Arithmetic Coding

The basic principle of arithmetic coding is to encode frequently occurring symbols with the minimum number of bits and rarely occurring symbols with higher numbers of bits. Each symbol of the ensemble narrows the interval between 0 and 1 to reduce the number of bits. Arithmetic coding assumes an explicit probabilistic model of the source [32, 33]. Arithmetic coding uses the symbol-wise recursive method, in which a single data symbol is used for each iteration. It estimates the separation of the interval between 0 and 1. The entire interval is divided according to the probabilities of the symbols. For each symbol, this algorithm estimates the interval in one recursion. Thus, it encodes the data by generating a code string that corresponds to a fractional value that lies between 0 and 1.

Figure 4 illustrates the arithmetic coding for an ensemble, namely, $p(A) = 0.2$, $p(B) = 0.3$, and $p(C) = 0.5$, and the code generation is presented in Table 1.

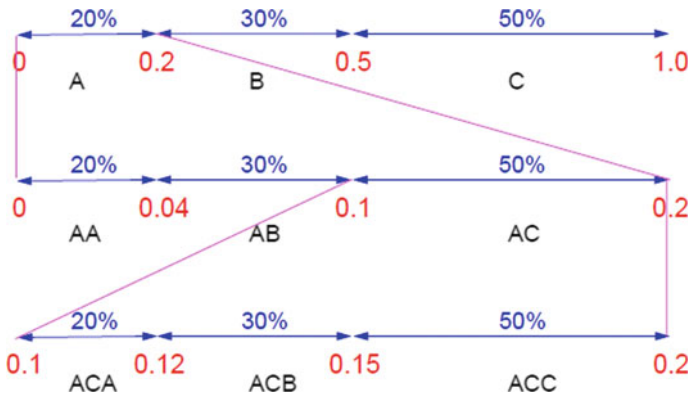

Fig. 4 Code generation for arithmetic coding

Table 1 Arithmetic-coded output

Symbols	Lower bound	Upper bound	Output
A	0.0	0.2	–
AC	0.1	0.2	–
ACB	0.12	1.15	1
A	0	0.2	–
AA	0	0.02	0

3.5 Source Coding

The compression can be very efficiently performed on frequency domain data, compared to time domain counterparts. In this compression method, the original time domain data are transformed into their frequency domain counterparts via FFT and DCT. Subband source coding compresses only the critical frequency ranges of the data stream and discards the other frequency ranges. This method is used in vocoder for speech communication [34].

The simple audio compression systems are G.711, G.722, and G.723. The G.711 audio coding scheme uses pulse code modulation (PCM) with 64 kbps. The G.722 audio coding scheme uses delta pulse code modulation (DPCM) with data rates of 48, 56, and 64 kbps. The G.723 audio coding scheme uses Multi-pulse maximum likelihood quantizer data rates of 6 to 3 kbps and algebraic codebook excitation linear prediction (ACELP) rates of 5 to 3 kbps.

Video and audio conferencing compression methods that are used currently are G.728, AV.253, and IS-54. The G.728 scheme is employed using the low delay code excited linear prediction (LD-CELP) coding with a coding speed of 16 kbps and a duration of less than 2 ms. This complex CODEC algorithm requires 40 MIPS to complete coding and decoding. The coding speed of AV.253 is 32 kbps. IS-54 uses VSELP with a coding speed 13 kbps. It performs well on voice data and poorly on music.

The two types of coding methods for mobile telephone networks are RPE-LTP (GSM) and GSM half-rate coders. RPE-LTP (GSM) stands for regular pulse excitation—long-term predictor. Its coding speed is 13 kbps and it is used for speech communication in European GSM networks. The coding speed range of GSM half-rate coders is 5.6–6.25 kbps.

JPEG stands for Joint Photographic Expert Group, which developed this compression standard with the joint support of ISO/IEC JTC1/SC2/WG10 and Commission Q.16 of CCITT SGVIII. It is an international standard for the coding and compression of both grayscale and color images with a compression ratio of 10:1. JPEG is a common compression system. It does not depend on the image resolution, image or pixel aspect ratio, color coordinate system, image complexity, or statistical characteristics. It is a clear interchange format of encoded data that is implemented in both software and hardware. MOTION JPEG is used for video compression by encoding image sequences.

4 Image Compression Standards

IoT-enabled digital imaging devices, such as scanners and digital cameras, produce a massive amount of image data, which motivates the development of image compression standards for efficient processing and storage. The JPEG standards are JPEG, JPEG XT, JPEG-LS, JPEG 2000, JPEG XR, JBIG, AIC, JPSearch, JPEG Systems,

JPEG XS, and JPEG Pleno. In this section, we demonstrate that the JPEG STANDARD, which is the wavelet-based JPEG 2000 standard, which is more efficient in compressing IoT multimedia big data.

4.1 JPEG Standard

The Joint Photographic Experts Group developed the JPEG standard for the efficient compression of images in 1992, which was the result of continuous efforts that began in 1986. They released the latest version of JPEG in 1994. JPEG is a lossy compression method, in which a high compression ratio was realized by discarding some visual information [35]. This loss of information did not affect the visual quality of the natural scene images. This will have an effect in medical images. In the JPEG compression standard, the reconstructed image is not an exact replica of the original image. The compressed output data stream is produced from the input image, with a continuous process of DCT, quantization and binary encoding on 8×8 -pixel blocks.

The five functional steps of the JPEG image compression technique are color space conversion, spatial subsampling, DCT, quantization, and coding, as illustrated in Fig. 5. In the first stage, the RGB image is converted into Y, C_b , C_r . In the second stage, the C_b and C_r image components are subsampled separately with a size of 2×2 pixels. In the third stage, the spatial domain data are converted into their frequency domain counterparts by applying 2D DCT on Y, C_b , C_r individually. The frequency domain information is quantized in the fourth phase and, finally, the quantized frequency domain information is encoded using Huffman coding.

The JPEG encoding process is illustrated in detail in Fig. 6. The processes that are involved in encoding are the color transform, 8×8 DCT, uniform scalar quantization, DPCM, zigzag scan, variable-length coding, run-length coding, and marker insertion. Finally, the compressed data of the input image are output as a JPEG file.

4.1.1 Color Transform and Level Offset

The transformation matrix that is presented as Eq. 1 is used to convert the color image from RGB format to YUV format, which represents the luminance and chrominance

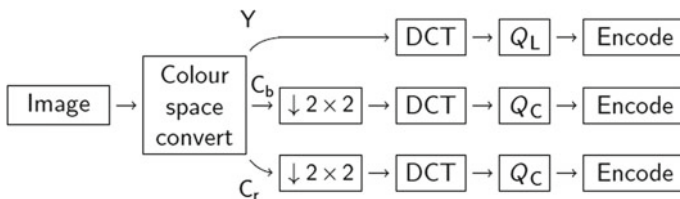

Fig. 5 Functional steps of JPEG image compression

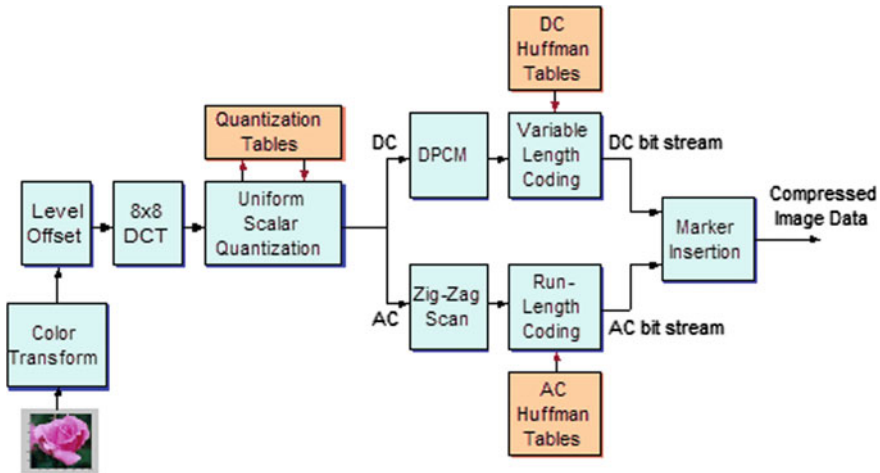

Fig. 6 JPEG algorithm encoding

images. The proper level offset of $[0, 128, 128]$ is also added to the resultant transformed image, namely, YUV. In addition, the further U and V images are subsampled to reduce the bit rate.

$$v_i^T = \begin{pmatrix} 0.299 & 0.587 & 0.114 \\ -0.1687 & -0.3313 & 0.5 \\ 0.5 & -0.4187 & -0.0813 \end{pmatrix} u_i^T + \begin{pmatrix} 0 \\ 128 \\ 128 \end{pmatrix}. \quad (1)$$

4.1.2 Discrete Cosine Transform

The 2D DCT transforms the pixels in $f(x, y)$ to the corresponding DCT coefficients, which are denoted as $F(u, v)$ via Eq. 2. The chrominance and luminance images are divided into subimages of size 8×8 . Then, DCT is performed on each 8×8 data matrix separately. Figure 7 presents the 8×8 subimage and its DCT coefficient matrix. The value in the upper left corner of the DCT coefficient matrix is the total signal energy. All other coefficients represent the high-frequency components of the image, which contain negligible amounts of visible information and can be discarded with a small amount of distortion. The forward transform of block f_b is expressed in Eq. 2.

$$F_b(u, v) = \frac{C(u)}{\sqrt{N/2}} \frac{C(v)}{\sqrt{N/2}} \sum_{x=0}^{N-1} \sum_{y=0}^{N-1} f_b(x, y) \cos \frac{(2x+1)u\pi}{2N} \cos \frac{(2y+1)v\pi}{2N} \quad (2)$$

where $0 \leq u, v < 8$ and $C(u) = \begin{cases} \frac{1}{\sqrt{2}} & u = 0 \\ 1 & u > 0 \end{cases}$

There are 64 DCT coefficients of the 8×8 block: 1 DC coefficient and 63 AC coefficients. The DC coefficient of the entire image contains all available information in that 8×8 block image. The 63 AC coefficients are ordered in “zig-zag” form with zero coefficients. Then, all the resultant coefficients are transformed into a code via Huffman coding to reduce the number of bits that are required to represent the coefficients. In this stage, a sufficient amount of compression is realized with an acceptable loss of information, without affecting the quality of the image. Since the pixels that correspond to higher frequency coefficients are discarded in DCT, the quality of the resultant image does not affect the visual nature of the original image.

4.1.3 Quantization

If the quantization step size is large, the image distortion is more severe because the image quality and the degree of quantization are inversely proportional to each other, however, the compression ratio is small. The selection of a suitable degree of quantization is crucial in the JPEG compression technique. Since the human eye naturally focuses more on low-frequency areas than on high-frequency areas, JPEG uses a larger quantization step size for a higher frequency components and a smaller step size for lower frequency components. In the 8×8 quantization matrix, the upper left coefficient has a small step size and the upper right coefficients have larger step sizes. The quantizer sets many high-frequency coefficients to zero to facilitate coding, hence, higher frequency coefficients lead to efficient compression.

4.1.4 Compression Technique

In the quantization process, many DCT coefficients are set to zero. Then, the quantized DCT coefficients are further encoded via run-length encoding. In run-length coding, each image block is represented by the quantized DCT coefficient and the number of zeros. The result of run-length coding is a record of the number of zeros and the corresponding nonzero coefficient. The DCT coefficients are processed in a zigzag pattern, as illustrated in Fig. 7, to combine the runs of zeros. In addition, it creates a pair of data that contains the information about the current coefficients, where the first element indicates the number of zeros and the second element is the number of bits that are needed to represent the coefficient. This pair was assigned with a variable-length codeword via either Huffman or Arithmetic coding. For every block of data, JPEG specifies two types of information: the code word of the pair and the code word for the amplitude of that coefficient. Along with the two codes, an end-of-block marker will be provided. Then, the same process will be repeated for all the blocks. The final segment data in the output stream is the end-of-file marker.

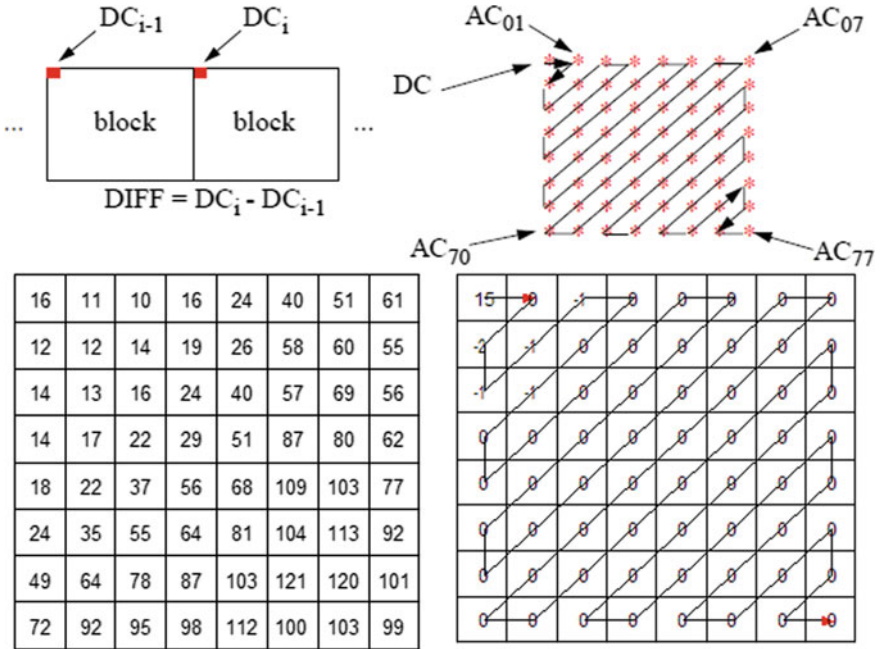

Fig. 7 Luminance quantization table (left) and the quantized DCT coefficients (right)

4.2 JPEG Compression Modes

The JPEG standard employs four modes of compression techniques to compress effectively all types of images: sequential, progressive, lossless and hierarchical. JPEG employs both Huffman and Arithmetic encoding procedures with either 8- or 12-bit resolution. Figure 8 illustrates the compression modes that are associated with the encoding techniques.

In the sequential mode of compression, images are encoded from top to bottom with precisions of 8 and 12 bits. In a single scan, each color component is encoded.

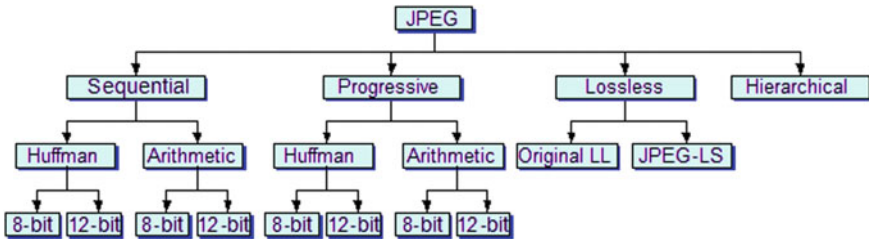

Fig. 8 JPEG operation modes

The sequential mode uses both Huffman encoding and arithmetic coding. In the progressive compression mode, several scans are employed for encoding image modules. The first scan produces a coarse style of the image and the subsequent scans produce progressively smoother versions of that image. Each component scanned a minimum of 2 and a maximum of 896 times. The lossless compression mode produces an exact replica of the original image with a small compression ratio. It is used much less frequently and is more suitable for the compression of medical images.

In the hierarchical compression mode, frames are created from the image by dividing the entire image into subimages. Each frame contains more than one scan of the image. The first frame generates a low-resolution version of the image and the remaining frames generate higher resolution versions of the same image.

4.2.1 JPEG Compressed Data Format

Figure 9 illustrates the JPEG compressed data format. Each data format starts with SOI and ends with EOI. In between SOI and EOI, various scans of the same frame with the frame header are available. The arrangement of a simple compressed image data format corresponds to a frame that begins with the frame header. The table information is provided before the frame header. In between SOI and EOI, scanning information is provided. The define number of lines (DLN) segment separates successive scans.

4.2.2 Decompression of JPEG

The block diagram shown in Fig. 10 provides a detailed functional description of the reconstruction procedure for a compressed JPEG image. This system is the exact reverse of the JPEG compression algorithm.

In the first step, the compressed data stream is applied to the table construction phase, from which the quantization table, DC Huffman table, and AC Huffman table are reconstructed. The decoded header information is used to determine the size and precision of the decompressed image. The DC and AC codes that belong to each 8×8 block are separated from the compressed data stream. The DC is decoded by retrieving the DC coefficient from the DC Huffman table. The sum of the DC coder value and the DC value of the previous block is obtained from the output of IDPCM, which is used as input to the subsequent operations. Similarly, the AC coefficient is retrieved from the AC code via decoding using the Huffman table [36]. The unzigzag operation restores the exact AC coefficient in 8×8 block size. After the dequantization, IDCT reconstructs replica of the original image that is inexact due to the quantization error. The chrominance and luminance images from IDCT are added with the offset value and converted into RGB format, as illustrated in Fig. 11.

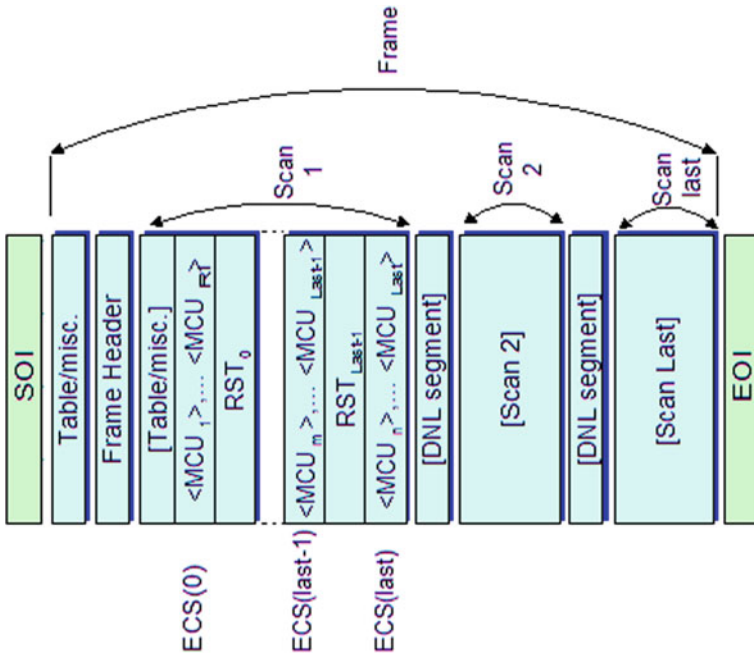

Fig. 9 Simple compressed image data format

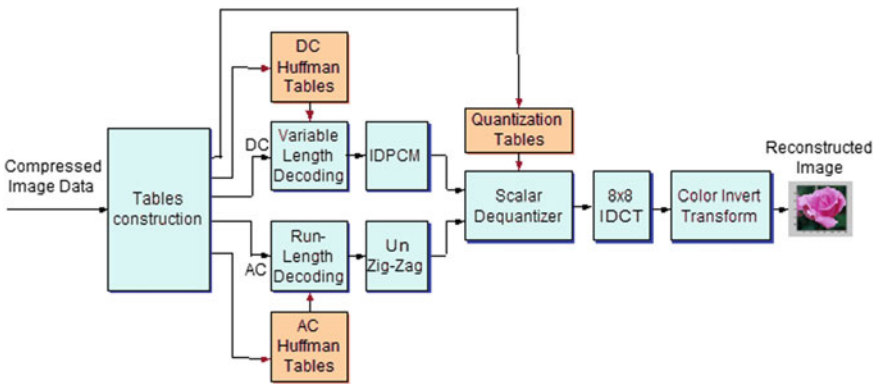

Fig. 10 JPEG decompression structure

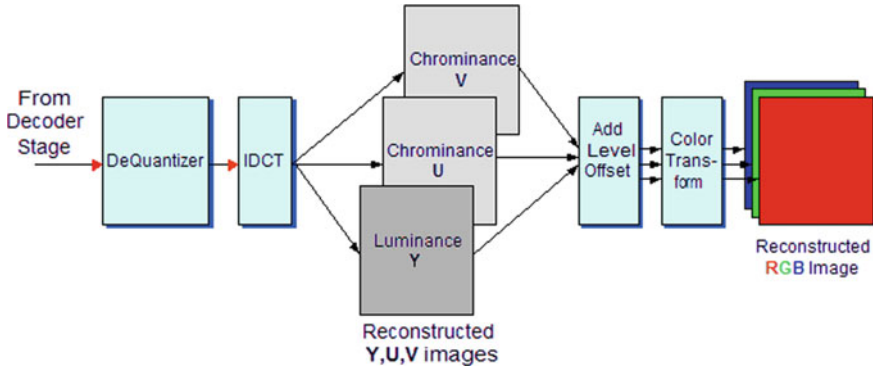

Fig. 11 Color inverse transformation at the decoder

4.3 JPEG 2000

The overall performance of the JPEG standard depends on the bit rate that is employed for compression, the acceptable amount of data loss and the noisy nature of the communication channel. JPEG is most suitable at high and moderate bit rate, but performs poorly for low bit rates. The wavelet decomposition that is used in JPEG 2000 overcomes the shortcomings of the JPEG standard. It is a collaborative achievement of JPEG with ISO and IEC. The embedded block coding with optimized truncation (EBCOT) algorithm enhances the JPEG 2000 standard to realize superior compression compared to JPEG. The compressed bits stream has resolution and SNR scalability and random access. The main features are lossless and lossy compression, protective image security, region-of-interest coding, and robustness to bit errors. JPEG 2000 provides higher quality compression using the lossy compression technique at low bit rates. The progressive decoding provides lossless compression. JPEG 2000 protects images with watermarking, labeling, stamping or encryption. The region-of-interest coding technique yields a higher degree of compression with low information loss. The coded bitstream is more robust to transmission errors due to the use of error-resilient tools.

4.3.1 JPEG 2000 Codec

The compression system for the JPEG 2000 standard is illustrated in Fig. 12. The encoding process consists of preprocessing, forward transform, quantization, and entropy coding, similarly to other compression standards. The unique feature of this standard is that each subband has a different step size for the process of quantization and we can skip quantization to achieve lossless compression in the case of medical images [37]. Another significant advantage of this standard is the use of bit plane coding in the process of entropy coding, which assigns high coding priority to the

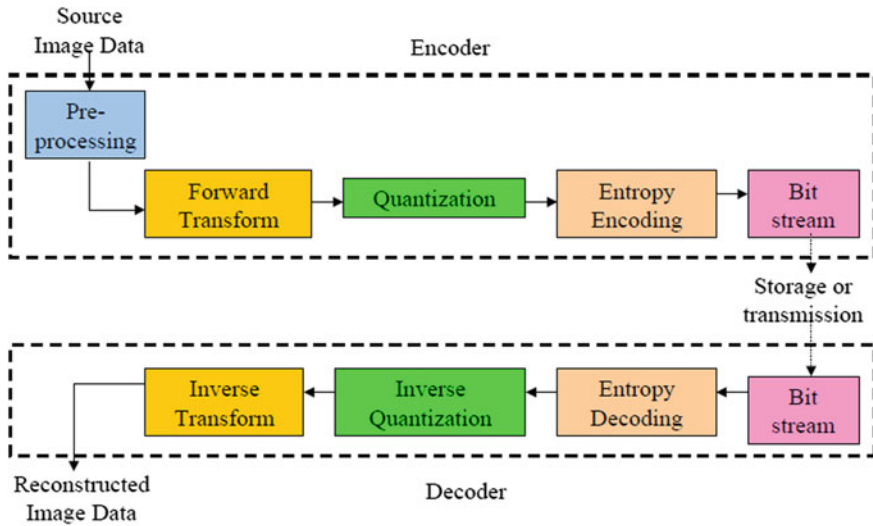

Fig. 12 JPEG 2000 compression engine

MSB plane compared to the other bit planes. In arithmetic coding, this standard encodes the data stream via a context-based approach. This provides higher quality scalability by decoding the bit plane partially. The decoding begins from the MSB bit plane. The quantization step is repeated after discarding the 1-bit plane from the decoding process.

The three preprocessing steps are image tiling, color transformation, and DC level shifting. Among these, image tiling and color transformation are optional for each image component [38]. The sample of each image component is subtracted from the same quantity in DC level shifting. The color transformation transforms RGB into Y, C_b, C_r .

Forward Transform

In this standard, the image is decomposed into multiresolution subbands via the discrete wavelet transform (DWT), which is also an important component of the JPEG 2000 standard. The low-pass samples represent a down-sampled, low-resolution version of the original set and the high-pass samples represent a down-sampled residual version of the original set (details). The 2D DCT decomposed the image into four frequency levels: LH, HL, HL, and HH. These spectral subbands differed from one another in terms of visual quality. The HH subband contains the low-frequency information and LH contains the high-frequency information of the horizontal details. The high-frequency information of the vertical details is available in the HL subband and HH contains the high-frequency information of the diagonal details.

Quantization

After transformation, all coefficients are quantized via scalar quantization. The quantization reduces the precision of the coefficients. The operation is lossy unless the quantization step size is 1 and the coefficients are integers. The quantization formula is presented below.

$$q_b(u, v) = \text{sign}(a_b(u, v)) \frac{|a_b(u, v)|}{\Delta_b} \quad (3)$$

where

$q_b(u, v)$ is the quantized value
 $a_b(u, v)$ is the transform coefficient of subband b
 Δ_b is the quantization step size
 $|a_b(u, v)|$ is the largest integer that does not exceed a_b .

Modes of Quantization

Quantization is achieved by two modes: the integer mode and the real mode. The integer-mode quantization uses integer-to-integer transforms, a fixed quantization step and bit plane discarding. The real mode uses real-to-real transforms, a rate control-based-quantization step and bit plane discarding [39].

The entropy encoder encodes each code block individually. As illustrated in Fig. 13, each subband is split into several precincts, which are rectangular. The three spatially consistent rectangles comprise a packet. The code block is created after further dividing the precinct into nonoverlapping rectangles. The code blocks in a packet are scanned in raster order. The values of a code block are converted to bit planes [40]. The MSB of each coefficient in the code block is coded via entropy coding. The code blocks, precincts, and packets that are used in JPEG 2000 and the entire process of a single code block are illustrated in Fig. 13.

JPEG 2000 Bitstream and Layers

JPEG 2000 generates an individual stream of codes for each code block, which is contained within a packet. In multilayer encoding of an image, all the encoded data that correspond to a code block are disseminated through packets that correspond to various layers. Figure 14 illustrates the JPEG 2000 bitstream and the structure of the layer [41].

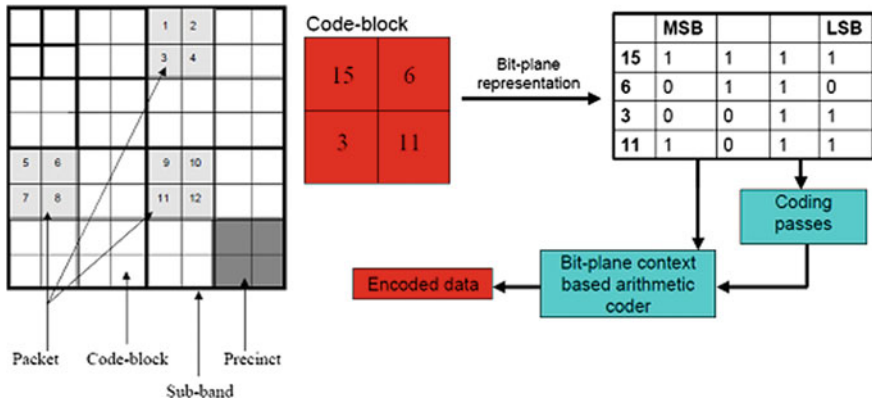

Fig. 13 Code blocks, precincts and packets and code block processing

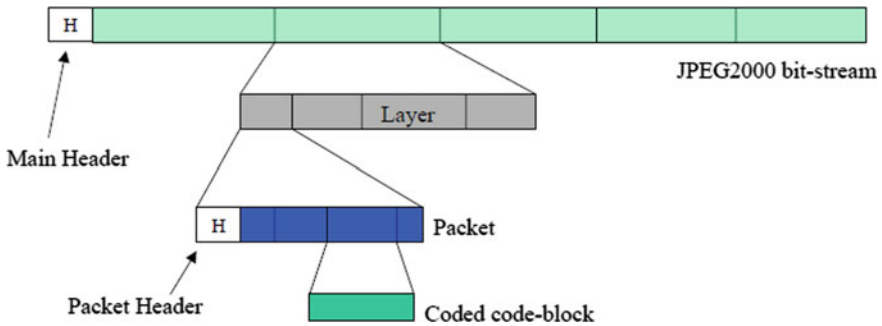
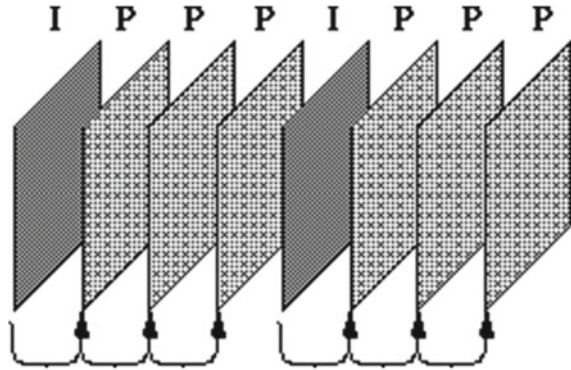

Fig. 14 JPEG 2000 bitstream and the structure of the layer

4.4 H.261 Standard

ITU-T recommended H261 for video compression in video conferencing and video telephony over ISDN lines, in combination with standards H221, H230 H242, and H320, during the period 1988–1990. It performs the decoding and encoding at the rate of $p \cdot 64$ kbps (the range of p is 1–30). It defines the various components in a video conferencing system. It achieves a high compression ratio by removing both spatial and temporal redundancies of video sequences. It supports the common intermediate format (CIF) with an image resolution of 352×288 pixels and quarter CIF (QCIF) with an image resolution of 176×144 pixels, with a maximum frame rate of 30 frames per second. The frame rate can be reduced based on the application and bandwidth availability. The input images are coded as a luminance and two color difference components (Y, C_b, C_r). The luminance matrix is double the size of the C_b and C_r matrices [42]. The encoded sequence consists of one I-frame (intra-frame) followed by three consecutive P-frames (inter-frames), as illustrated in Fig. 15. JPEG is used for I-frames and P-frames use pseudo differences from previous frames.

Fig. 15 Encoding sequence



The H.261 encoder is composed of three main steps: Prediction, Block transformation and Quantization & Entropy Coding.

In the prediction step, H261 uses both intra-coding and inter-coding. The resultant coded image is passed to the block transformation step, along with the prediction error. In the block Transformation step, the 8×8 block that is received from the prediction step, which consists of both coded frames and the prediction error, is subjected to the two-dimensional FDCT algorithm for conversion into a coefficient matrix. In the last step, quantization and entropy coding are applied to the DCT coefficients, which provides additional compression. Motion vector search, propagation of errors and bit-rate control are the three important, challenging issues in the H.261 standards.

4.4.1 Bitstream Structure

The bitstream structure of compression standard H.261 is illustrated in Fig. 16. The boundaries between pictures are designated with picture start code (PSC). The timestamp for each picture is indicated with a temporal reference (TR). The picture type (PType) is used to specify the type of frame as either P-frame or I-frame [37].

Fig. 16 Encoding sequence

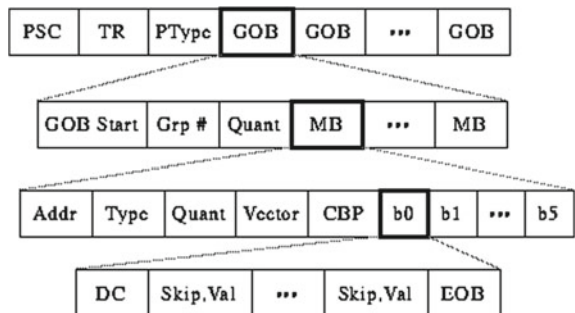

The group of blocks (GOB) component of the bitstream indicates the separation of the picture into 11×3 macroblock regions. The group number (Grp #) indicates whole groups that should be skipped and the group quantization value (GQuant) indicates the single quantization value for the whole group.

5 Conclusions

The Internet of Things technology has generated a radical increase in the production of multimedia big data and is likely to transform enterprises, industries, and homes globally. The resultant tremendous amount of multimedia data has caused a scarcity of storage and a shortage in bandwidth for transmission, processing and receiving. It is essential and inevitable to develop methods for influencing the usage trajectory of the Internet of Things. The combined effort of researchers and scientists is necessary for the development of effective compression techniques for handling the tremendous amount of multimedia big data that is available in IoT.

This chapter, which is devoted to the compression of IoT multimedia big data, contains technical information that was obtained via the combined effort of many writers, academic investigators, technical investigators, scientific societies, software organizations, and professionals from various geographical areas. Exploring these technical details has motivated the recent research by the students and scientists who are working in this area. This effort also provides the opportunity to exchange knowledge between scientists and various technical societies.

In addition, this effort provides proper guidance for scholarly societies who are supporting the IoT industry and the processing and compression of multimedia big data from IoT applications. Almost all experts unanimously agree that compression of multimedia big data is an important and unavoidable requirement for the assurance of an excellent QoS in all multimedia applications. Almost all compression techniques that are used on multimedia big data currently can be applied to multimedia big data from a variety of IoT-enabled sources.

We have confidence that research on multimedia compression will yield optimal performance for all encoders that are applied to multimedia big data. Actions are already being taken by scientific societies on improving compression standards. IoT systems must accommodate the specifications of multimedia big data so that they can be incorporated into an international standard. This will provide assurance regarding the durability of multimedia big data. In addition, preprocessing and postprocessing techniques improve the quality of multimedia big data.

The compression of multimedia big data is now unanimously acknowledged as compulsory for enhancing the availability of bandwidth and storage requirements. Therefore, all compression standards and techniques can be applied to mono-dimensional, two-dimensional and multidimensional multimedia big data. It is also important to consider the security of multimedia big data during compression because IoT information is freely transmitted over the internet. We are confident that our presentation in this chapter properly guides scientists, scholars, and IoT professionals in conducting additional research in the area of multimedia big data compression.

References

1. L. Atzori, A. Iera, G. Morabito, The Internet of Things: a survey. *Comput. Netw.* **54**, 2787–2805 (2010)
2. D. Evans, The Internet of Things: how the next evolution of the internet is changing everything (2011)
3. S. Kumari, S. Tanwar, N. Tyagi, M. Kumar, K.K.R. Maasberg, Choo multimedia big data computing and Internet of Things applications: a taxonomy and process model. *J. Netw. Comput. Appl.* **124**, 169–195 (2018)
4. F.H. George, V. Jeffrey, W.M. Keith, The Internet of Things: a reality check. *IEEE Comput. Soc.* **14**(3), 56–59 (2012)
5. The Statistics Portal. Internet of Things (IoT) connected devices installed base worldwide from 2015 to 2025 (in billions) (2017), <https://www.statista.com/statistics/471264/iot-number-of-connected-devices-worldwide/>
6. IDC. Internet of Things Market Statistics (2016), <http://www.ironpaper.com/webintel/articles/internet-of-things-market-statistics/>
7. A. Kumari, S. Tanwar, S. Tyagi, N. Kumar, Fog computing for healthcare 4.0 environment: opportunities and challenges. *Comput. Electr. Eng.* **72**, 1–13 (2018)
8. L. Jie et al., A survey on Internet of Things: architecture, enabling technologies, security and privacy, and applications. *IEEE Internet of Things J.* **99**, 1 (2017)
9. S. Tanwar, P. Patel, K. Patel, S. Tyagi, N. Kumar, M.S. Obaidat, An advanced internet of thing based security alert system for smart home, in *International Conference on Computer, Information and Telecommunication Systems (IEEE CITS-2017)*, Dalian University, Dalian, China, 21–23 July 2017, pp. 25–29 (2017)
10. D.X. Li, H. Wu, L. Shancang, Internet of Things in industries: a survey. *IEEE Trans. Ind. Inform.* **10**, 2233–2243 (2014)
11. L. Yu, Y. Lu, X. Zhu, Smart hospital based on Internet of Things. *J. Netw.* **7**, 1654–1661 (2012)
12. P. Mark, G. Eric, C. Ryan, F. Samantha, W. Leon, C. Hsinchun, Uninvited connections: a study of vulnerable devices on the Internet of Things (IoT), in *Proceedings of the 2014 IEEE Joint Intelligence and Security Informatics Conference (JISIC)*, The Hague, The Netherlands, pp. 232–235 (2014)
13. W. Zhu, P. Cui, Z. Wang, G. Hua, Multimedia big data computing. *IEEE Multimedia* **22**(3), 96–106 (2015)
14. S.-C. Chen, R. Jain, Y. Tian, H. Wang, Special issue on multimedia: the biggest big data. *IEEE Trans. Multimed.* **1** and **17**, 1401–1403 (2015)
15. M.K. Jeong, J.-C. Lu, X. Huo, B. Vidakovic, D. Chen, Wavelet based data reduction techniques for process fault detection. *Technometrics* **48**(1), 26–40 (2006)
16. M. Chen, S. Mao, Y. Liu, Big data: a survey. *Springer Mob. Netw. Appl. J. (MONET)* **19**(2), 171–209 (2014)
17. M. Chen, S. Mao, Y. Zhang, V.C. Leung, *Big data: related technologies, challenges and future prospects* (Springer, New York, NY, 2014)
18. K. Wang, J. Mi, C. Xu, L. Shu, D.-J. Deng, Real-time big data analytics for multimedia transmission and storage, in *Proceedings of IEEE/CIC International Conference on Communications in China (ICCC)*, Chengdu, China, pp. 1–6 (2016)
19. S.A. Hyder, R. Sukanesh, *An Efficient Algorithm for Denoising MR and CT Images Using Digital Curvelet Transform*. Springer Advances in Experimental Medicine and Biology—Software Tools and Algorithms for Biological Systems, vol. 696, Part 6, pp. 471–480 (2011)
20. A. Yassine, A.A.N. Shirehjini, S. Shirmohammadi, Bandwidth on demand for multimedia big data transfer across geo-distributed cloud data centers. *IEEE Trans. Cloud Comput.* **PP**(99), 1 (2016)
21. D. Ren, L. Zhuo, H. Long, P. Qu, J. Zhang, MPEG-2 video copy detection method based on sparse representation of spatial and temporal features, in *Proceedings of IEEE Second International Conference on Multimedia Big Data (BigMM)*, Taipei, Taiwan, pp. 233–236 (2016)

22. A. Paul, A. Ahmad, M.M. Rathore, S. Jabbar, Smartbuddy: defining human behaviors using big data analytics in social Internet of Things. *IEEE Wirel. Commun.* **23**(5), 68–74 (2016)
23. JPEG 2000 image coding system—Part 8: JPSEC Final Committee Draft—Version 1.0, ISO/IEC JTC1/SC29/WG1N 3480 (2004)
24. J. Yosef, S.A. Hyder, An efficient artifact free denoising technique for MR images relying on total variation based thresholding in wavelet domain. *ICGST J. Graph. Vis. Image Process.* **18**(1) (2018)
25. JPEG 2000 image coding system—Part 1: Core Coding System, ISO/IEC JTC 1/SC 29/WG 1 15444–1
26. T. Ebrahimi, C. Christopoulos, D.T. Lee, Special issue on JPEG-2000. *Image Commun. J.* **17**(1) (2002)
27. T. Ebrahimi, D.D. Giusto, Special section on JPEG2000 digital imaging. *IEEE Trans. Consum. Electr.* **49**(4), 771–888 (2003)
28. JPEG 2000 image coding system—Part 9: Interactivity tools, APIs and protocols, ITU-T Recommendation T.808, ISO/IEC 15444–9, July 2004
29. S. Pouyanfar, Y. Yimin, C. Shu-Ching, S. Mei-Ling, S.S. Iyengar, Multimedia big data analytics: a survey. *ACM Comput. Surv.* **51**(1), Article 10, 34 (2018), <https://doi.org/10.1145/3150226>
30. C.A. Bhatt, M.S. Kankanhalli, Multimedia data mining: state of the art and challenges. *Multimed. Tools Appl.* **51**(1), 35–76 (2011)
31. C. Min, A hierarchical security model for multimedia big data. *Int. J. Multimed. Data Eng. Manage.* **5**(1), 1–13 (2014)
32. S. Kaneriyaa, S. Tanwar, S. Buddhadev, J.P. Verma, S. Tyagi, N. Kumar, S. Misra, A range-based approach for long-term forecast of weather using probabilistic markov model, in *IEEE International Conference on Communication (IEEE ICC-2018)*, Kansas City, MO, USA, 20–24 May 2018, pp. 1–6 (2018)
33. C. Shu-Ching, Multimedia databases and data management: a survey. *Int. J. Multimed. Data Eng. Manage.* **1**(1), 1–11 (2010)
34. C. Ming, S. James, J. Zhanming, Connection discovery using big data of user-shared images in social media. *IEEE Trans. Multimed.* **17**(9), 1417–1428 (2015)
35. O.H. Ben, W. Matthew, JPEG compression, in *Student Projects in Linear Algebra*, ed. by D. Arnold (2005). Accessed 2009
36. P. Penfield, Chapter 3: compression, in *Notes* (MIT, 2004). Accessed 6 Sept 2009
37. P. Charles, Digital video and HDTV: algorithms and interfaces, in *The JPEG Still Picture Compression Standard*, ed. by G.K. Wallace. Communications of the ACM, 1 April 1991, pp. 30–44 (1991)
38. J. Yosef, Principal component analysis based multimodal medical image fusion of MRI and CT in wavelet domain, in *Transactions on Mass-Data Analysis of Images and Signals*, Vol. 9, no. 1, pp. 17–30, September (2018). ISSN: 1868–6451
39. T.P. Mahsa, D. Colin, A. Maryam, N. Panos: HEVC: the new gold standard for video compression. *IEEE Consum. Electr. Mag.* pp 36–46 (2012)
40. O.-R. Jens, J.S. Gary, S. Heiko, K.N. Thiow, W. Thomas, Comparison of coding efficiency of video coding standards—including high efficiency video coding (HEVC). *IEEE Trans. Circuits Syst. Video Technol.* **22**(12), 1669–1684 (2012)
41. K.R. Rao et al., *Video Coding Standards, Signals and Communication Technology* (Springer Science Business Media, Dordrecht, 2014), https://doi.org/10.1007/978-94-007-6742-3_2
42. W. Raymond, F. Borko, *Real-Time Video Compression—Techniques and Algorithms*, vol. 376, 1st edn. (Springer Science Business Media, Dordrecht, 1997)

Large-Scale MMBD Management and Retrieval



Manish Devgan and Deepak Kumar Sharma

Abstract This chapter explores the field of Multimedia Big Data management and retrieval. Multimedia data is a major contributor to the big data bubble. Therefore, we require separate databases for storing and managing it, hence, the chapter covers all the requirements of a Multimedia DBMS. Multimedia data modelling has also been covered since multimedia data is mostly unstructured. Further, the chapter covers the annotation and indexing techniques that help manage the large amount of multimedia data and finally followed by a detailed description about different databases that can be used for storing, managing and retrieving the Multimedia Big Data. Different databases such as SQL and No-SQL approaches are discussed such as Graph, Key-Value DBs, Column Family, Spatio-temporal Databases.

Keywords Big data · Database management · Storing multimedia data · Indexing of MMBD · Performance and retrieval capacities · Different databases · Graph DBs · Spatio-temporal · Data modelling

1 Introduction

In the recent years, with the emergence of mobile and internet technologies, the world has seen a massive growth in the use of multimedia such as video, images, text and audio, etc., and this has resulted in a big revolution in multimedia data management systems (Wikipedia.com 2018). With the emergence of new technologies and the advanced capabilities of smartphones, smart televisions and tablets, people, especially younger generations, spend a lot of time on the internet and social networks to communicate with others to share information [1]. This information can be in the

M. Devgan · D. K. Sharma (✉)
Division of Information Technology, Netaji Subhas University of Technology, (Formerly Known as NSIT), New Delhi, India
e-mail: dk.sharma1982@yahoo.com

M. Devgan
e-mail: manish.nsit8@gmail.com

© Springer Nature Singapore Pte Ltd. 2020
S. Tanwar et al. (eds.), *Multimedia Big Data Computing for IoT Applications*, Intelligent Systems Reference Library 163,
https://doi.org/10.1007/978-981-13-8759-3_9

form of text, audio, image or even video graphics. This vast amount of information is called 'big data'.

Unlike traditional alphanumeric data, multimedia data is usually unstructured and noisy. Conventional data analysis is not a feasible mode to handle this huge amount of complex data. Therefore, more comprehensive and sophisticated solutions are required to manage such large and unstructured multimedia data.

The biggest challenge of big data analytics is how to reduce the time consumed to store and manage this data while producing accurate results from the datasets. Multimedia big data explains what is happening in the world, emphasizes hot daily news, shows special events and can be used to predict people's behaviour and preferences.

In this book chapter, we first introduce the basics of Multimedia data and the emergence of Big Data in Multimedia. We discuss the requirements that are essential for a Multimedia Database Management System to function properly and produce efficient results. Further, the chapter covers the annotation and indexing techniques that help manage a large amount of multimedia data. Finally, a detailed description of the databases that can be put to use for storing, managing and retrieving the Multimedia Big Data. The aim of the chapter is not just to make the reader understand the concept of managing the data but also to allow them to question the possibilities of improving the already available methods.

1.1 What Comprises Multimedia Data

'In computation, data is *information* that has been translated into a form that is efficient for movement or processing. Relative to today's computer systems and transmission media, data is information that has been converted into digital form'. It is acceptable for data to be used as a singular subject or plural subject. Raw data is the term that is mostly used to designate data in its most primitive form. Data is, as of today, one of the most important factors that define the company's value. The better data collection and processing is applied the better is the outcome of the product or project.

Terms like '*data processing*' and '*electronic data processing*' have made data a big influence in the field of business computing, which for a time, came to encompass the full gamut of what is now known as information technology. With the advent of computational statistics in corporate world, a distinct data profession termed as corporate data processing emerged.

Currently, we no longer just communicate using text as the only source of communication. There are multiple media that we can use to transmit the information. Multimedia data is a term that is composed of 'Multimedia' and 'Data', Multimedia is further a split of 'Multiple Media', that can be used for transmission and Data is the statistic collected that will be processed and analysed. Multimedia data can comprise of any one or more of the following media such as text, audio, still images, animation, video or other types of media.

Multimedia data can be stored, easily recorded, displayed and even interacted with or accessed by multimedia processing devices, and can also be a part of live performance. Currently, most of the electronic devices are capable of all multimedia functionalities. Multimedia is refining the way we share and interact with data. In contrary to how we share them, it also affects our decisions since products and companies use data analytics on multimedia data to predict future and provide a better solution to our queries.

1.2 Big Data in Multimedia

Data is, as stated above, information that has been translated into a form that is efficient for movement or processing. With the advent of mobile technology and Internet, there has been a rapid increase in the amount of multimedia data that humans have produced in a very few times. Today, we generate over 2.5 quintillion bytes of data everyday which consists of text, audio, video and other types of multimedia data, which is shared on data sharing and social media platforms such as Facebook, Instagram and more (IBM, 2013). The increase in the use of Internet of Things (IOT) products are also contributing to the increasing rate of data being produced and dumped over the internet every single moment.

According to recent studies and surveys, around 527,760 images are shared on Snapchat every minute of the day, which is an image sharing platform service popular nowadays [2]. More than 120 people register every minute on LinkedIn, people watch over 4M YouTube videos every minute and post around 50k images on Instagram, an online social media platform (Koetsier, n.d.)

The above facts are enough to develop an understanding of the amount of data being dumped onto the server farms every day. Most of this data is image and video data and rarely comprise of texts. So, we can easily attach the term 'Big' with Multimedia Data. Big data is often characterized by the Five V's, which are Velocity, Volume, Value, Variety, and Veracity. These characteristics make the big data different from 'data' (Fig. 1).

In the next section, we will study about the requirements that a Multimedia Database Management System must have.

2 Requirements of a MMDBMS

There exist not many differences in the requirements for a Multimedia Database Management System (MMDBMS) than a regular Database Management System (DBMS). MMDBMS works alike a DBMS that is used for storing, accessing and managing the data.

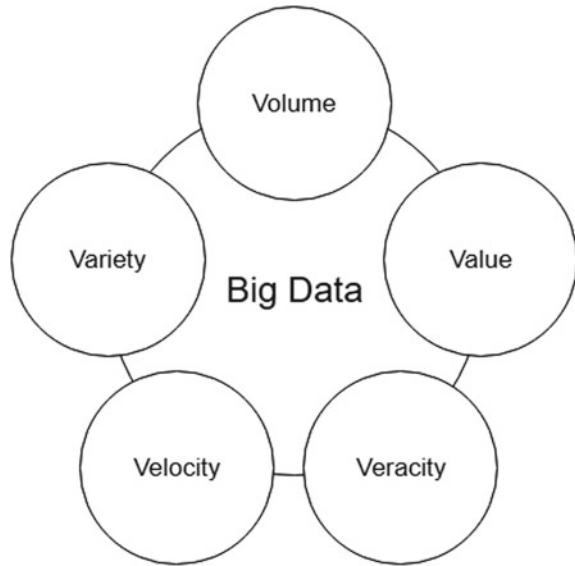
Fig. 1 Five V's of big data

There are several properties that serve as the basic requirements of a DBMS but additional capabilities such as the managing huge data, query support and intractability with multimedia data is defined as MMDBMS. Let us define the traditional capabilities in the section below.

2.1 Traditional Capabilities

Any MMDBMS should be able to serve as a regular DBMS before it can cater to the needs of multimedia data. It must have the basic capabilities as displayed by software such as *Oracle* (Oracle.com, 2018), *FoxPro* (VisualFoxPro, 2018), *SQL Server*, etc. A list of basic DBMS capabilities is listed below.

- Providing Data Definition Capabilities
 - Defining a DDL and providing a User-Accessible catalogue
- Providing facilities for storing, retrieval and updating data
 - Defining a Data Manipulation Language
- Supporting multiple views of data
 - An interacting application must see only the required information
- Providing facilities for specifying integrity constraints

- General Constraints
- Primary key constraints
- Secondary Key Constraints
- Controlling access to data
 - Preventing unauthorized access to the stored data
- Concurrency Control
- Supporting Transactions
- Database recovery and maintenance
 - Bringing data back to the consistent state in case of system failure
 - Unloading, reloading, validation etc.

The features defined above are the basic functionalities that a DBMS must possess. A MMDDBMS must have other multimedia and big data-specific features as well such as data modelling, huge capacity storage.

2.2 *Multimedia Data Modelling*

Before we understand the use of data modelling when dealing with multimedia data, we first need to understand what exactly is data modelling? Why is it needed? How is it related to multimedia?

What is Data Modelling?

Data modelling is a software engineering concept of processing raw data to make a data model for any information system using some or the other formal techniques. A data model is a modelling technique, i.e. organizes the elements of data and standardize as to how they relate to each other and to the real world [3].

Need for Data Modelling?

Data modelling techniques and methodologies are used to model data in a consistent, standard, predictable manner in order to manage it as a valuable resource. Any project that requires a standard means of defining and analysing the must follow set defined data modelling standards, which are [3]:

- Assisting programmers, business analysts, manual writers, testers, IT package selectors, engineers, managers, related organizations and clients to understand and use an agreed semi-formal model;
- Managing data as a resource;
- Integrating information systems;
- Designing databases and data warehouses (Fig. 2).

With the advent of IOT and devices such as smartphones, there is a humongous amount of multimedia data that get registered every day on the face of the internet

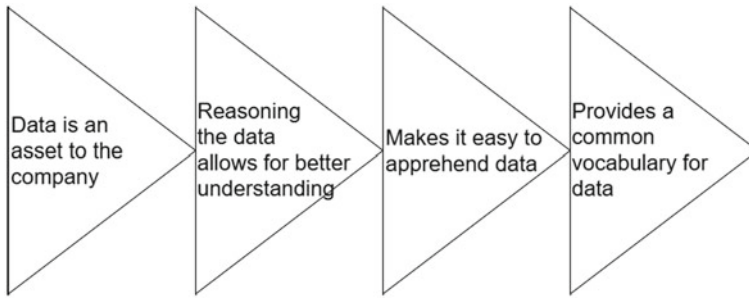

Fig. 2 Importance of data modelling

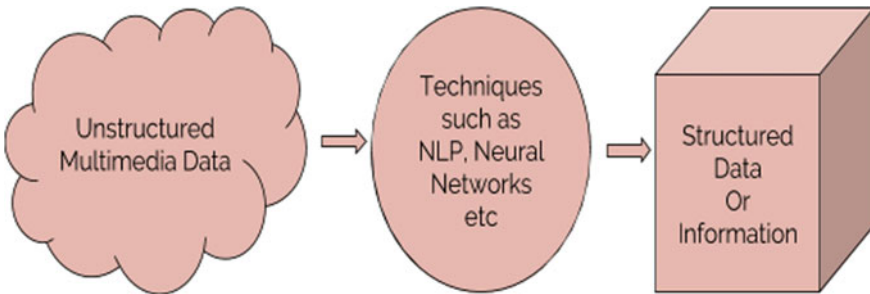

Fig. 3 NLP techniques for modelling data

and cloud storage. Managing, storing and retrieving this immense amount of data is not just tough but also time-consuming. Using techniques such as data modelling can certainly help in aiding to this problem of managing Multimedia Big Data (MMBD).

Although there are various existing models for traditional databases, such as network, relational and semantic models, only very few have been proposed for multimedia databases. The unique nature of multimedia data requires object-oriented data models for each type of media data that exists [3] (Fig. 3).

The question still is that how can we apply the theory of data models on such a vast amount of unstructured data to manage it properly? The problem is generally solved in a conventional way of applying specific schemes to data to make 'sense out of it'. In recent times, multimedia has contributed to a vast amount of information being produced over the internet in the last decade. Information retrieval or data modelling from unstructured multimedia data is done using advanced techniques such as Natural Language Processing (NLP), Neural Networks (NN) and more. A combination of above schemes along with Object-Relational Database Management System (ORDBMS) is also used to provide semantic retrieval. The ultimate goal of data modelling is to allow the automatic retrieval of target information based on formal information of the related domain.

2.3 *Huge Capacity Storage and Management*

Multimedia such as images and videos can vary in size ranging from a few megabytes to 3–4 gigabytes and even more. Due to the high volume and high variety of multimedia big data, the problem arises of storage management, which is characterized by its huge capacity of data storage and hierarchical structure. Appropriate storage mechanism for multimedia must be employed in order to achieve better results with analysis and predictions. Multimedia data comprises of interrelated objects that need to be stored perfectly to increase the throughput of the program (a program here can be anything from a large-scale software to a simple look-up machine for the stored data). These objects are placed in a hierarchical storage that can range from online to offline, with increasing storage capacity and decreasing performance. An example can be a simple server with, let's say ' n ' levels of data storage, the first ' m ' levels may use a Solid-state Storage Device (SSD) for storing the data whereas the rest ' $n-m$ ' levels can have greater storage capacity but less accessibility speed due to the usage of Hard Disk Drive (HDD).

There are a few examples of software that allow easy storage of big data, big multimedia data as well, which are listed below:

- Apache Hadoop [4, 5]

Apache Hadoop is a free and open-source software framework that allows effective storing of data in clusters. It runs parallelly and is capable of performing computation on every node simultaneously. It is a JAVA-based framework and uses the Hadoop Distributed File System (HDFS) as the storage system of Hadoop, which splits big data and distribute across many nodes in a cluster. This also replicates data in a cluster thus providing high availability. (hadoop.apache.org 2018) [6]

- Microsoft HDInsight

HDInsight is a cloud-based wrapper around Apache Hadoop provided by Microsoft.

- NoSQL

SQL can be used to handle structured data very well, but we need NoSQL (Not Only SQL) to handle unstructured data. NoSQL databases are schema-less databases. Every row can have a set of columns different from each other. They provide better performance in storing very large amount of data. There are many open-source NoSQL DBs available to analyse Big Data (Wikipedia & TechTarget 2018):

- Hive,
- Sqoop,
- Polybase, etc.

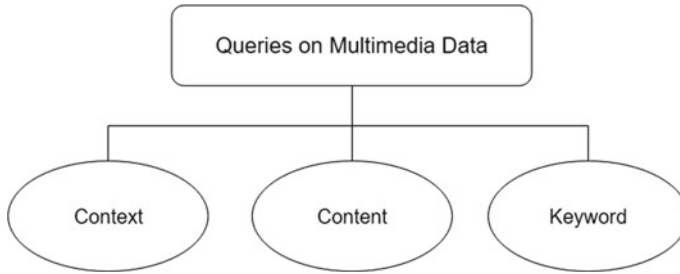

Fig. 4 Queries allowed (keyword, context and content based)

2.4 Query Support and Information Retrieval Capabilities

As we have discussed that the incoming multimedia data is enormous in amount, therefore, there can be numerous queries pertaining to a particular media. This high variety of multimedia data also requires multiple types of query support. It is not necessary to have direct queries produce an accurate result with multimedia data since it is unstructured in nature. A direct query is a query where the exact match for an object is the desired as the result but in case of multimedia data, instead of an exact match, the multimedia query usually results in a list of objects which is closely or somewhat related to query and are ranked in accordance of the relevance they have to the query (Fig. 4).

Therefore, to comprehend data of multiple types, there needs to be a different set of metrics that define the ranking strategies and mechanisms of different data types possible.

2.5 Multimedia Interface and Intractability

The diverse nature of multimedia data requires an intuitive and interactive interface for viewing and interacting with the MMDBMS. Before adding an interactive user interface, there is a need to integrate and compose the data. Data is first broken down into sub-pieces of information with an aim to integrate them into a form such that it can be easily presented.

Data integrity, as well as the uniqueness of multimedia data, must also be preserved. For example, data in the form of pictures and video may consume additional space due to it being distributed in pieces. This is called redundancy of data and leads to reduced memory space for unique data.

Once the composition of data is done, the next requirement becomes an interactive interface. Different media require different interfaces for presentation and query. Demand-based handling and retrieval of multimedia assets must also be a feature of the MMDBMS. It must be able to serve the purpose of indirect queries on multimedia

data which appeals to the user. Although serving indirect queries is an important issue but the performance of the system should not be affected.

2.6 Performance

Considering the five V's of multimedia big data, the performance of the DBMS is a big and important requirement which must be fulfilled in order to ensure the productivity of the product/application. The system must be efficient, reliable, supports real-time execution of queries, must guarantee delivery of multimedia assets in order of query, their integration and the Quality of Service (QoS) [7] acceptable to the user.

Therefore, a DBMS should be fast and secure. Neither should be compromised for the other in order to ensure a perfect database management system for multimedia big data.

3 Annotation and Indexing of Multimedia Big Data

In this chapter, we have been dealing with the topic of creating a DBMS software that allows us to easily store, retrieve and maintain the multimedia data. In any data storage software, annotation and indexing of records play a very important role. It determines the speed and also the accuracy by which the data will be retrieved for a particular query submitted into the MMDDBMS.

Let us study about what annotation and indexing are in terms of a DBMS and MMDDBMS.

3.1 Multimedia Annotations

'Annotation is a note added to a text, for example, a comment beside a topic of the book is an annotation' [8]. In real life, annotation helps in understanding the topics better as well as makes the lookup of different topics and categories a lot easy for the reader of the book.

Similarly, annotations play a significant role in assisting in data management and retrieval, specifically for heterogeneous and unstructured data. The data that is raw and needs a significant amount of cleaning is benefited from this technique [9] (Fig. 5).

There are two main categories of multimedia annotations:

1. Manual,
2. Automatic.

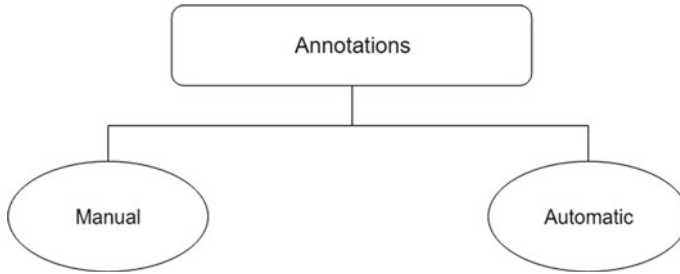

Fig. 5 Manual and automatic annotations

Since the data is to mark with specific notes, it can either be done by the user or a machine can be employed to do the same work. Therefore, two kinds of annotation techniques exist.

Manual Annotation

The manual process of annotation of incoming multimedia data is very time consuming for the uploader/user. The annotation process is about understanding the multimedia data from start to end (in case of audio and video) and marking all annotations in order of occurrence.

Although this process need not give the desired result, therefore a set of rules must be followed by all the annotators while making annotations for multimedia (or any) data.

- Reading/Understanding the data
 - Viewing the data of the multimedia image, video or audio in its entirety to generate an understanding of the raw available data.
- Marking the entities
 - This step involves a proof reading of the document and marking any available entities that occur in the document
- Looking Again
 - Reviewing your work to be certain about the fact that no possible annotation is missed and also that the features are correctly mapped according to their occurrence in the data.
- Recording any additional information
 - The annotator is expected to record the experience while annotating the document/data. This can be done using other tools to make comments or sometimes can be done using the annotation tool itself (Fig. 6).

These sources of annotation are reliable but this process is very time-consuming as it wastes a big amount of time from the user's side to add comments or metadata about

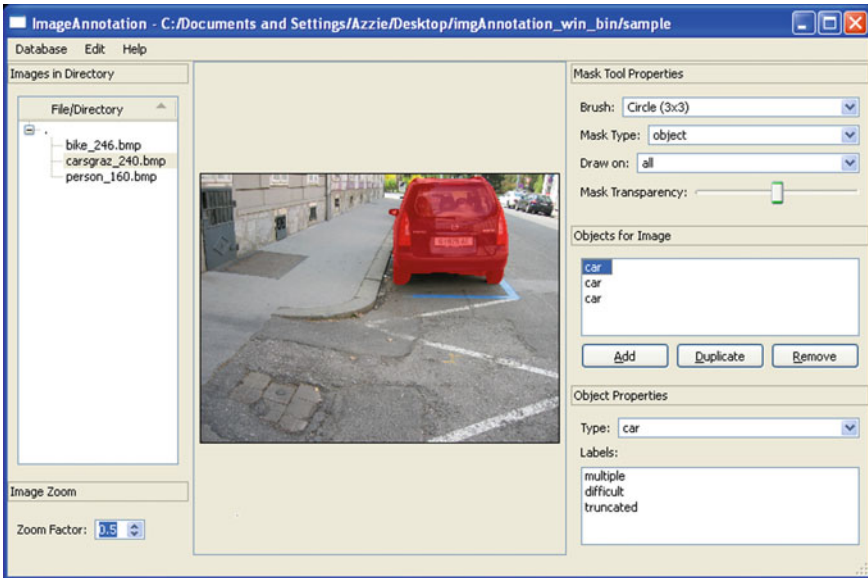

Fig. 6 LEAR is an image annotation tool for windows

the multimedia data. The problem becomes even more serious when the growing entropy of the big data bubble is taken into consideration.

Therefore, a new faster method must be devised to prepare annotations for the multimedia data. So, we have the automatic annotation process.

Automatic Annotation Process

The automatic annotation process is backed by the highly sophisticated machine learning algorithms, which is more appealing than the manual method, considering the ever-increasing amount of data. However, it is more challenging because of the notorious semantic map problem. Semantic mapping is a process of creating a map which can be used *to visually display the meaning-based connections between a word or a phrase and a set of unrelated words*. With access to the shared information available over the connected network and to heterogeneous sources, the problem involving terminology provision and interoperability of systematic vocabulary schemes still exist and require urgent attention [10]. Therefore, solutions are needed to improve the performance of full-text retrieval system.

Although using machine learning algorithms to ease out the work seems a good option for the difficulties associated with its implementation must also be taken care of.

In spite of big challenges and difficulties of multimedia automatic annotation, there have been many research endeavours in this hot topic. One such research is to use Latent Dirichlet Modelling (LDA) to extract semantic topics from multimedia

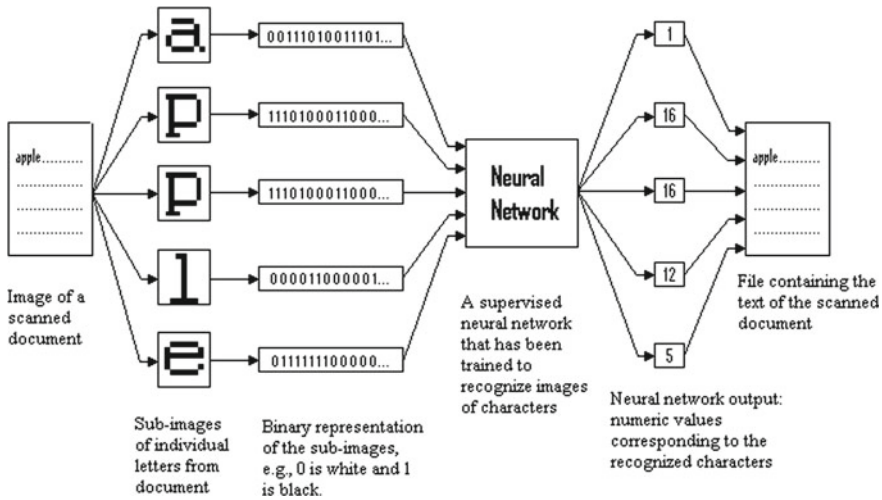

Fig. 7 Using neural nets to identify text from images to provide better annotations

text documents such as still images [11]. Some other seek the combination of both humans as well as the computer for multimedia data annotation.

Deep Learning, a field of Machine Learning, involving the extensive use of Artificial Neural Networks is also being used to generate annotations for images, videos, and audio. Deep Nets have shown promising results when compared to conventional machine learning algorithms.

Figure 7 shows how we can use images of scanned images and convert it into a file of the same using supervised neural networks. It is a case of Optical Character Recognition or OCR, which is used to convert written text into digital text by identifying the words in an image using a pre-trained neural network.

3.2 Multimedia Indexing

As mentioned earlier, multimedia big data is mostly unstructured. This means that the data is lost in a relational sense. While the traditional RDBMS were used for managing the structured data, this means that they could not be used for managing multimedia data without any change. To solve this problem, a number of indexing strategies have been proposed, targeting different types of data and queries. The indexing strategies can be roughly categorized into AI approaches and the non-AI approaches [12].

Specifically, the non-AI approaches treat each individual item independently and do not rely on the context or data relationships. They can be further classified into tree-based strategies, such as *R-Tree*, *B-Tree*, *Hash*, *X-Tree*, *Gist* and inverted indexing cloud services can be answered by retrieving and ranking the corresponding list of documents [13, 14]. On the other hand, the AI approaches capture the data semantics by analysing the relationship between the data and the context among them to better structure and organize the multimedia data items. These advantages of AI approaches make them more accurate and effective than the non-AI methods. However, they are generally more complicated and computationally expensive. The AI methods are still a field of vast studies and research [15].

4 Storage and Retrieval

As discussed before, we know that storage is the main purpose of why we employ databases in the first place. It is to store the important information and use it thereafter, for example, to enhance the customer experience. There are multiple types of databases that can be employed to store the multimedia data, and each of it has its unique feature (Fig. 8).

There are two basic types of databases that can be employed to store the multimedia data so that it can be used further, viz. SQL and no-SQL. Their capabilities of storing and retrieving vary to different extents, so we are going to study about them.

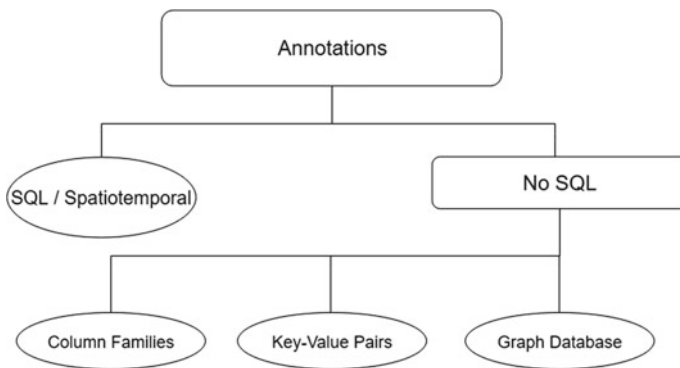

Fig. 8 Spatio-temporal and NoSQL databases

4.1 Spatio-temporal Databases

Spatio-temporal means to consist of both space and time. In a spatio-temporal database, as the name suggests, the emphasis is laid on space-time information.

Use case of Spatio-temporal Databases

Spatio-temporal database is capable of analysing data that exists in either space, time or both of the frames. It is therefore suitable for the following purposes:

- Keeping track of moving objects. The objects in a moving plane are known to exist at a single position at any given frame of time. This is an apt example of the space-time dependent data.
- A data consisting of wireless communication networks, which may exist only for a short timespan within a particular geographic region
- Maintaining an index of animal species in a given region, a new species may be found or an old one can become extinct, so this is also an example for spatio-temporal data
- Tracking historical plate data and more

We can also make use of artificial intelligence to predict the behaviour of the object that has the characteristics stored in a spatio-temporal database.

Since multimedia is unstructured raw data, therefore, using spatio-temporal databases for time-dependent data is a big advantage for managing and storing time-dependent data. Some example of spatio-temporal data are GPS, payments, digital photos, any smartphone data, etc. (Figs. 9 and 10).

Implementing Spatio-temporal DB

Since there are no RDBMS that incorporate a spatio-temporal database therefore it must always be implemented so that it can be used. Since the extensions do not exist, so it is very difficult to implement it. Software such as TerraLib (TerraLib, Open Source), which is an open-source project, uses a middleware approach for storing data in a relational database. The theory of this area is not completely developed. Another approach for this is to use constraint database system such as MLPQ or Management of Linear Programming Queries (Fig. 11).

4.2 No-SQL Databases

A NoSQL database provides a software mechanism for storing, managing and retrieving data that is modelled in means other than the relational tables used in relational databases [3].

Big data and real-time web applications make consistent use of NoSQL Databases.

Many NoSQL stores compromise on consistency in favour of availability, partition tolerance and speed. It is not used to a much greater extent due to its use of low-level query languages, lack of standardized interfaces, and huge previous investments in

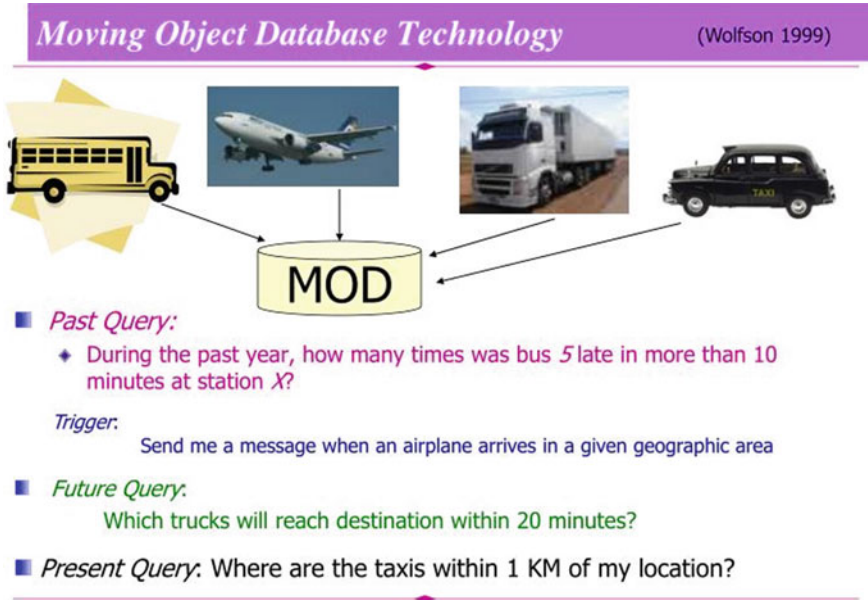

Fig. 9 Examples of using spatio-temporal queries

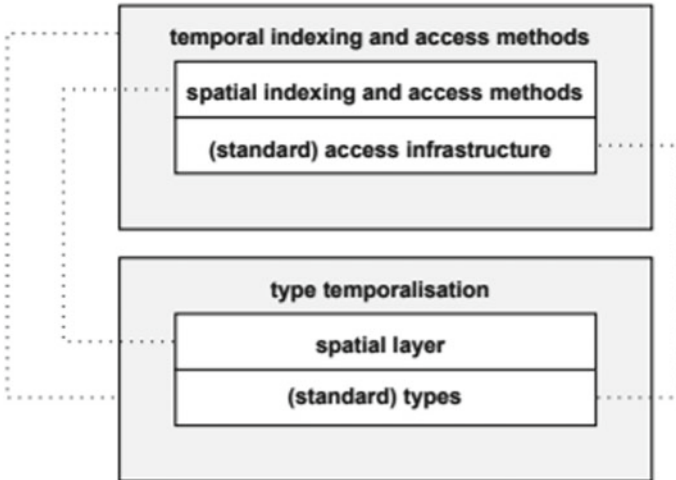

Fig. 10 The storage manager in a spatio-temporal DBMS



Fig. 11 TerraLib and Geomesa are open-source tools

existing relational databases. But it's ability to be able to hold multiple types of data under a single collection is what makes it so popular and a good choice for storing multimedia data.

NoSQL Databases—Types

There are multiple types of NoSQL Databases that are used to store, retrieve and manage data. Some of these may overlap with the other in terms of functionality. Below is a classification of NoSQL tables with respect to data model:

- Column,
- Document,
- Key-Value,
- Graph.

Uses of NoSQL DBs

NoSQL is not specific to store just text but all kind of data, be it large or small, text or image, it works perfectly on any kind of data. It is considered a distributed, efficient, and non-relational database. Most of the conventional database cannot store and manage the Binary Large Objects data or BLOB data. BLOBs are a set of default binary data that can be used to store any type of multimedia objects. However, unstructured multimedia data can be stored, processed and analysed using NoSQL schema-less documented-oriented architecture to treat data more efficiently and flexibly [16].

4.2.1 Key-Value Stores

Key-value databases are designed to *store, retrieve and manage* a collection of objects which can be string, JSON, BLOB or anything [3]. It is a giant mapping of a key with its associated value. This collection of objects is generally called as a dictionary or a hash. Each object in a dictionary is identified by a unique key that is used to quickly retrieve the data in the database.

Compared to relational databases, key-value store significantly improves the performance due to the cache techniques used for mapping. Amazon Simple Service S3 (Dynamo) is a cloud-based key-value store that is most commonly used for storing large data (Fig. 12).

Key-Value databases can use *consistency models* which can range from eventual consistency to *serializability* [3]. There are some stores which support ordering

Fig. 12 Key-value representation of data

Key	Values
Key 1	AAA, BBB, CCDA
Key 2	2018/09/01, BAAD
Key 3	3,ZAA, AABD
Key 4	AAB, CCD, KFC

of the keys. Some of the stores manage the data inside the memory, RAM while others simply employ secondary storage such as solid-state drives and/or hard disk comprising of the rotating disks.

Redis is on one of the most popular key-value database implementations. There are other services such as the Oracle NoSQL DB in which every entity is a set of key-value pairs. Every key has multiple components, specified as an ordered list.

The *major key* is used to identify the entity and generally consists of the *leading components* of the major key [3]. This means that one can move from the outer key to inner key easily. This is similar to the way in which the directories are arranged. One directory inside the another. Whereas can be any string of object, text or even image encoded as text. Some examples of Key-Value Store/Database are Apache Ignite, Redis, Level DB and Oracle NoSQL Database (Fig. 13).

Amazon S3 is a cloud bucket which has key-value service and is utilized as cloud storage service because of its encryption and security mechanisms. It is simple to integrate and use [17].

One of the problems of the key-value store is the fact that key-value technique lacks consistency or atomicity of the transactions. In addition, maintaining the keys for a very large-scale data may be troublesome for use in general as well as may result in a greater time complexity for search and retrieval.

4.2.2 Graph Database

So far, we have discussed SQL and NoSQL databases, now we will study about graph databases. Graph database as the name suggests is a database that makes extensive use of graph as a sole data structure associated with this database.

Fig. 13 An example of directory listing

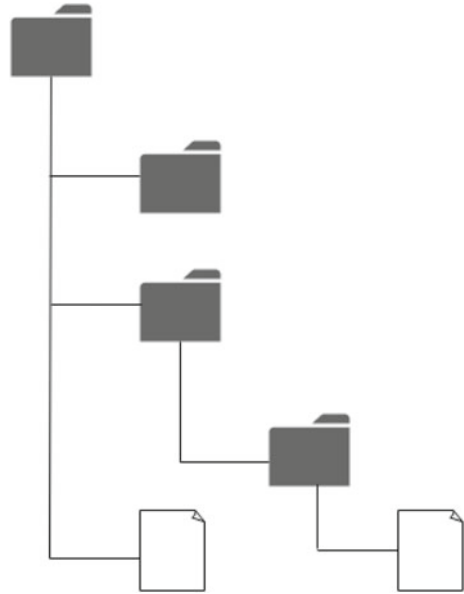

Design of a Graph DB

The key concept of this design is the node and edge system of the graph, which allows the data to be linked to any node in any possible way. This allows a multi-relational design in which any data can be directly or indirectly connected to other using edges. This is different from the relational database design as the links in the relational tables are logical and can be consumed with operations such as ‘join’ but in case of graph database they can simply be done using the physical links between the nodes. Executing relational queries is possible with the help of the database management systems at the physical level [3], which allows boosting the performance without modifying the internal logical structure of the database. The main advantage of the graph structure is *the simple and fast retrieval of complex hierarchical structures* that are difficult to model and implement.

Normally, a graph database is a NoSQL structure since it uses key-value structure or document-oriented database for storing data (Fig. 14)

Properties of Graph DB

One of the important properties of the graph database is the use of tags or properties to annotate the stored. Tags are just another pointer to a document of a similar kind. This allows for easy mass retrieval of data at once.

Like other NoSQL databases, maintaining the consistency of data is not inherently done by the graph databases, and hence, the application system is responsible for governing the consistency over the graph data.

The other tough tasks that are included in this data structure is to scale out the graph database and finding a way to design generic queries.

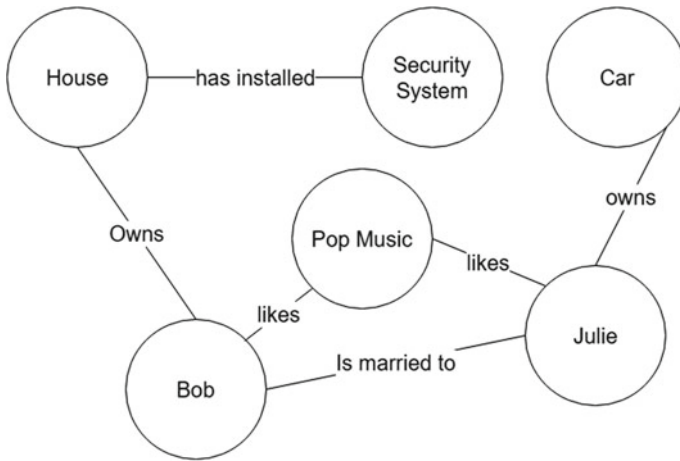

Fig. 14 Graph data

Data retrieval from a graph database requires a different query language that is not just simple SQL, but it needs to be better than SQL and can therefore support the graph structure. There have been many graph query languages but none has been accepted as the industry standard as SQL was for relational databases. Most graph databases allow access using an application programming interfaces or APIs.

Example usage of graph databases is to perform queries like ‘*computing the shortest path between two points in a graph*’. Graph also makes different other queries easily possible.

4.2.3 Column Families and Document Stores

Unlike relational DBMSs (RDBMSs) that store data in rows, column-based NoSQL databases store data in columns, which results in a fast and scalable data search. In column family databases, all the cells related to a column are placed in a continuous disk entry while in an RDBMS, each row is stored in different parts of the disk. Therefore, wide-column stores allow extremely large and unstructured data management, which is essential in multimedia big data analytics. They can also scale well in very big datasets where non-complex key-value pairs are insufficient. Google’s BigTable, Cassandra and HBase are the most popular column families. BigTable [18] for instance, has several main advantages, such as data sparsity, distribution across multiple clusters, multidimensionality, persistence and key-value mapping.

However, one of the major downsides to column families is the expensive writes as data are split into several columns, while this cost can be amortized in very large streaming writes. In document-based NoSQL databases, data including a set of key-value pairs are stored as documents where the values have an encoded structure such as XML and JSON.

Advantages

The advantage of this structure is that the document stores embed metadata aliased with the data contents. In addition, any complex data can be represented as a document and can be stored in these databases. However, this powerful schema-less characteristic can also raise the potential for accidents and abuse, as well as performance issue.

MongoDB—Popular Open-Source DB

MongoDB is a popular document-based database that is publicly available and is written in C++ (MongoDB.Com 2016). It usually stores and groups documents based on their structure. In MongoDB, Binary JSON is the encoded format used to store unstructured or semi-structured documents such as multimedia and social media posts, and the indexing is very similar to that of relational databases. MongoDB has several advantages, such as durability using the Master–Slave replication technique and concurrency using locks, while the main limitation of this database is its limited data storage per node. It is also widely used for social data and multimedia big data analytics.

5 Conclusion

In this chapter, we've studied about what is multimedia data, how can it be stored and what are the ways in which the database can be made ensuring that this unstructured data can be stored inside it. We have also learned about the typical characteristics about the multimedia big database management system. The things that define a good database system are the traditional database capabilities, data management and huge capacity storage, multimedia data modelling, media integration and a lot more.

We've also studied about how annotation can help in making the data retrieval process easy and the ways to annotate the multimedia or any regular data. The process of indexing can be a much helpful process when it comes to gather information and execute queries.

Finally, we studied about various types of databases that can be used to store the multimedia big data. The only two types are SQL and NoSQL, for example, the spatio-temporal database that deals with both space and time and NoSQL are divided into further types such as the key-value, document store, graph database, etc. We read about how different techniques work, how they are implemented and how can we use them in regular day to day for a company or a project which has multimedia data at a large extent.

There were citations of different software that can be chosen as an apt database for the use case as and when desired.

The purpose of the chapter was to impart knowledge about the field of database management and retrieval in multimedia big data, readers can also check out the references to other research papers and websites to read more.

References

1. S.-C. Chen, Multimedia databases and data management: a survey. *Int. J. Multimedia Data Eng. Manage.* 1(1), 1–11
2. E. Adler, Social media engagement: the surprising facts about how much time people spend on the major social networks (2016). Retrieved from <http://www.businessinsider.com/social-media-engagement-statistics-2013-12>
3. V. Abramova, J. Bernardino, NoSQL databases: MongoDB vs Cassandra, in *Proceedings of the International C* Conference on Computer Science and Software Engineering.* (ACM, 2013), pp 14–22
4. Hadoop, Apache Hadoop (2018). <http://hadoop.apache.org>
5. Mahout, Apache Mahout (2018). <http://mahout.apache.org>
6. D.A. Adjeroh, K.C. Nwosu, Multimedia database management—requirements and issues. *IEEE MultiMedia* 4(3), 24–33 (1997)
7. Kumari, S. Tanwar, S. Tyagi, N. Kumar, M. Maasberg, K.K.R. Choo, Multimedia big data computing and internet of things applications: a taxonomy and process model. *J. Netw. Comput. Appl.* 124, 169–195 (2018)
8. V. Alvarez, S. Richter, X. Chen, J. Dittrich, A comparison of adaptive radix trees and hash tables, in *Proceedings of the 31st IEEE International Conference on Data Engineering.* 1227–1238 (2015)
9. F. Amato, F. Colace, L. Greco, V. Moscato, A. Picariello, Semantic processing of multimedia data for e-government applications. *J. Vis. Lang. Comput.* 32(2016), 35–41 (2016)
10. S.-C. Chen, R.L. Kashyap, A spatio-temporal semantic model for multimedia database systems and multimedia information systems. *IEEE Trans. Knowl. Data Eng.* 13(4), 607–622 (2001)
11. P.K. Atrey, M. Anwar Hossain, A. El Saddik, M.S. Kankanhalli, Multimodal fusion for multimedia analysis: a survey. *Multimed. Syst.* 16(6), 345–379
12. F. BintaAdamu, A. Habbal, S. Hassan, R.L. Cottrell, B. White, I. Abdullahi, A Survey on Big Data Indexing Strategies. Technical Report. SLAC National Accelerator Laboratory (2016)
13. D. Che, M. Safran, Z. Peng, From big data to big data mining: challenges, issues, and opportunities, *Database Syst. Adv. Appl.* (Springer, Wuhan, China, 2013), pp. 1–15
14. K. Chatterjee, S.-C. Chen, HAH-tree: towards a multidimensional index structure supporting different video modelling approaches in a video database management system. *Int. J. Inf. Decis. Sci.* 2(2), 188–207
15. R. Bryant, R.H. Katz, E.D. Lazowska, Big-data computing: creating revolutionary breakthroughs in commerce, science and society (2008). Retrieved from <https://pdfs.semanticscholar.org/65a8/b00f712d5c230bf0de6b9bd13923d20078.pdf>
16. T. Chardonnens, Big data analytics on high velocity streams: specific use cases with storm. Master's thesis. Software Engineering Group, Department of Informatics, University of Fribourg, Switzerland (2013)
17. Amazon AWS official docs
18. F. Chang, J. Dean, S. Ghemawat, W.C. Hsieh, D.A. Wallach, M. Burrows, T. Chandra, A. Fikes, R.E. Gruber, Bigtable: a distributed storage system for structured data. *ACM Trans. Comput. Syst.* 26(2), 4:1–4:26

Data Reduction Technique for Capsule Endoscopy



Kuntesh Jani and Rajeev Srivastava

Abstract The advancements in the field of IoT and sensors generate a huge amount of data. This huge data serves as an input to knowledge discovery and machine learning producing unprecedented results leading to trend analysis, classification, prediction, fraud and fault detection, drug discovery, artificial intelligence and many more. One such cutting-edge technology is capsule endoscopy (CE). CE is a non-invasive, non-sedative, patient-friendly and particularly child-friendly alternative to conventional endoscopy for diagnosis of gastrointestinal tract diseases. However, CE generates approximately 60000 images from each video. Further, when computer vision and pattern recognition techniques are applied to CE images for disease detection, the resultant data called feature vector sizes to 181548 for one image. Now a machine learning task for computer-aided disease detection would include nothing less than thousands of images leading to highly data intensive task. Processing such huge amount of data is an expensive task in terms of computation, memory and time. Hence, a data reduction technique needs to be employed in such a way that minimum information is lost. It is important to note that features must be discriminative and thus redundant or correlative data is not very useful. In this study, a data reduction technique is designed with the aim of maximizing the information gain. This technique exhibits high variance and low correlation to achieve this task. The data reduced feature vector is fed to a computer based diagnosis system in order to detect ulcer in the gastrointestinal tract. The proposed data reduction technique reduces the feature set to 98.34%.

Keywords Data reduction · CAD · Capsule endoscopy

K. Jani (✉) · R. Srivastava

Computer Science and Engineering Department, Indian Institute of Technology (BHU),
Varanasi, India

e-mail: kunteshj.rs.cse17@iitbhu.ac.in

R. Srivastava

e-mail: rajeev.cse@iitbhu.ac.in

© Springer Nature Singapore Pte Ltd. 2020

S. Tanwar et al. (eds.), *Multimedia Big Data Computing*

for IoT Applications, Intelligent Systems Reference Library 163,

https://doi.org/10.1007/978-981-13-8759-3_10

1 Introduction

The advancements in the field of IoT and sensors generate a huge amount of data. This huge data serves as an input to knowledge discovery and machine learning producing unprecedented results leading to trend analysis, classification, prediction, fraud and fault detection, drug discovery, artificial intelligence and many more [1]. One such cutting-edge technology is capsule endoscopy (CE). CE was introduced in the year 2000 by Given Imaging Inc, Israel. CE is a non-invasive, non-sedative disposable and painless alternative to conventional endoscopy procedure [2]. It provides a comfortable and efficient way to view the complete gastrointestinal (GI) tract [3]. The endoscopic device a swallowable capsule with 3.7 g weight and 11×26 mm dimensions. This capsule is ingested by the patient and it is propels through the GI tract by natural peristalsis. Figure 1 presents various components as well as the length of the capsule. The capsule captures the images of the GI tract and transmits it to a receiver. This receiver is tied on the waist of the patient. The experts then with the help of a computer system analyze the received video to detect irregularities of the GI tract. With endoscopic techniques such as colonoscopy and conventional endoscopy, it is not possible to visualize the entire small intestine. Since the CE can help the doctors visualize the entire GI tract without using any sedation, invasive equipments, air-inflation or radiation, the use of this technology is increasing in hospitals. To provide timely decision from specialists on remote location, CE can be combined with IoT [4] and mobile computing technology. Looking at various restrictions related to memory, power of the battery and the available communication capabilities, the transmitting and study of these CE video data gets even more challenging.

Figure 2 presents a general idea of computer-aided CE system. While propelling through the GI tract, the capsule transmits data to receiver at frame rate of 2 frames per second. Approximately 8 h later when the procedure ends, the images are retrieved into a computer for experts to study for potential abnormalities. Patient passes the capsule from the body through natural passage. There is no need to retrieve the capsule. Thus problems related to sterilization and hygiene is automatically addressed.

By year 2015 since its approval by the U.S. food and drug administration (FDA), more than 10 lac capsules have been used [8]. However, CE videos length ranges from 6 to 8 h generating 55000–60000 frames which make the analysis time-consuming. Depending on the expertise of the examiner, the examination would take 45 min to 2 h.

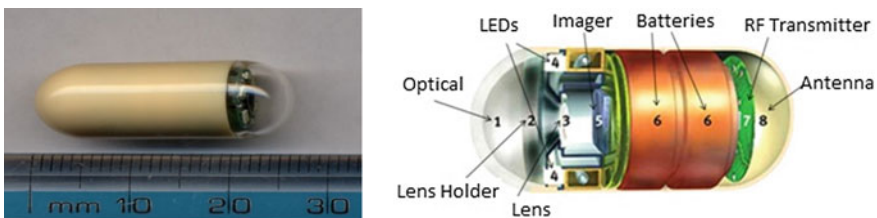

Fig. 1 Capsule length and components [5, 6]

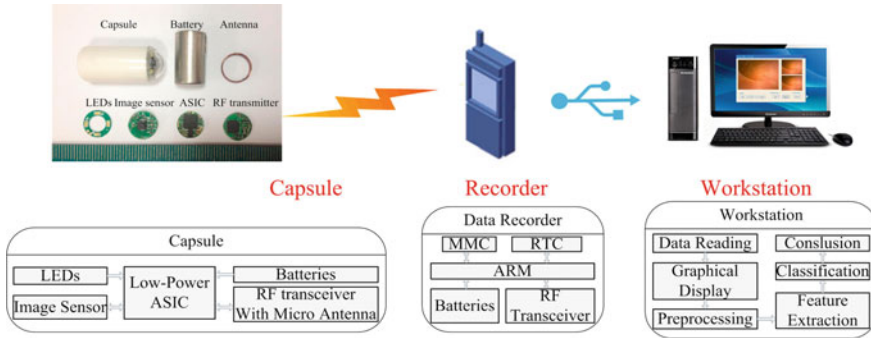

Fig. 2 Capsule endoscopy system [7]

In addition to a huge number of frames, GI tract appearance, and intestinal dynamics, the need for constant concentration further complicates the diagnostic and analysis procedure. With advancements in technology, the volume of data is likely to grow by many folds [9]. Thus, using computer vision and machine learning together build as a computer-aided diagnosis (CAD) system and artificial intelligence in health care can be a great help for experts and physicians in diagnosing the abnormalities [10, 11]. A CAD system capable of analyzing and understanding the visual scene will certainly assist the doctor with a precise, fast and accurate diagnosis. After manual analysis of CE video, CAD can also provide a second opinion to a gastroenterologist. In medical imaging, CAD is a prominent research area capable of providing a precise diagnosis. The ultimate goal of a CAD is to limit the errors in interpretation and search. It also aims to limit the variation among the experts. In particular, a computer-aided medical diagnostic system for CE can consist of following units: (1) a data capturing and transmitting unit—the capsule (2) a data receiver and storage unit—the waist belt (3) a data processing unit for pre-processing and feature extraction (4) a machine learning based classification unit or decision support system (5) a user interaction unit for final diagnostic report. In general, a complete automated abnormality detection system comprises of a pre-processing unit, segmentation unit, feature extraction unit, and classification unit. CE images also contain un-informative images such as noise, dark regions, duplicate frames, bubbles, intestinal fluids and, food remains. By pre-processing it is important that such un-informative regions or images be isolated. Poisson maximum likelihood estimation method may be used to remove Poisson noise [12]. Pre-processing noticeable improves computational efficiency and overall detection rate. The task of pre-processing and feature extraction unit is to supply a CAD system friendly data [13]. Few methods adopted for pre-processing in CE are contrast stretching, histogram equalization and, adaptive contrast diffusion [14].

Segmentation is the process of extracting only a useful or informative part from the whole image. This process will help us concentrated only on the required portion instead of whole image. Segmentation is performed using edge based or region based or a combination of both approaches. Both methods have their advantages

and disadvantages. Many techniques have been used in CE images for segmentation such as Hidden Markov Model(HMM) [15], total variation(TV) model [16] and, the Probabilistic Latent Semantic Analysis(pLSA) [17]. TV is a hybrid active contour model based on region and edge information; HMM is a statistical Markov model and, pLSA is an unsupervised machine learning technique.

Features in image analysis refer to a derived set of values providing discriminative and non-redundant information of the image. For visual patterns, extracting discriminative and robust features from the image is the most critical yet the most difficult step [18]. Researchers have explored texture, color, and shape based features in spatial as well as frequency domain to discriminate between normal and abnormal images of CE.

Classification is the last phase of the automated system. The process to predict unknown instances using the generated model is referred to as classification. Figure 3 presents a diagrammatic representation of the entire process.

Amongst all GI tract abnormalities, the most common lesion is an ulcer. The mortality rate for bleeding ulcers is nearly 10% [19]. Two of the important causes of GIT ulcers are non-steroidal anti-inflammatory drugs (NSAIDs) and bacteria called *Helicobacter pylori* (*H. pylori*). A un-treated ulcer may lead to ulcerative colitis and Crohn’s disease. Thus a timely detection of ulcer is a must. Table 1 presents a summary of various ulcer detection systems.

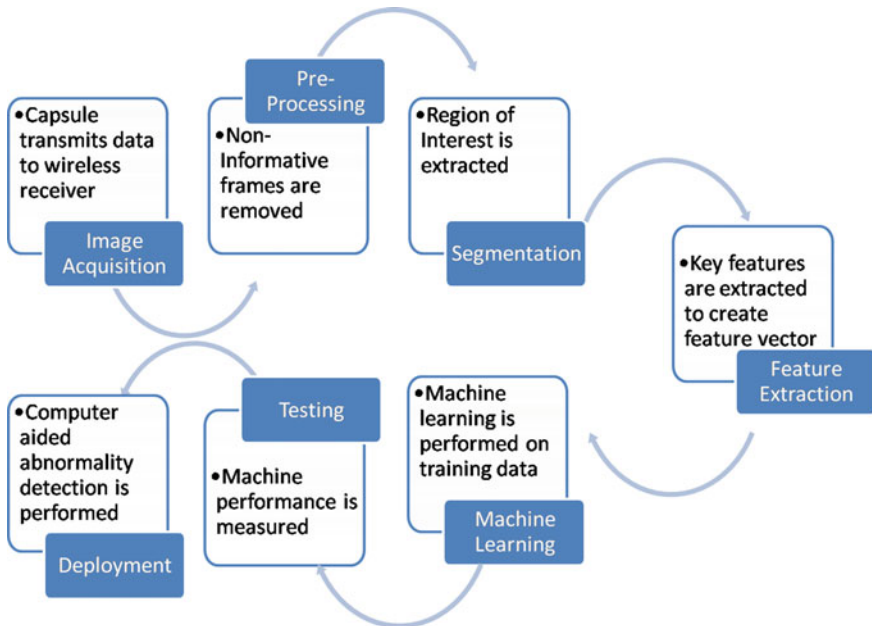

Fig. 3 Diagrammatic representation of entire process

Table 1 Summary of prior art on ulcer detection

Work	Features used	Method/classifier used	Limitations	Performance	Dataset size
[20]	Texture and color	SVM	Very less number of data samples	Accuracy = 92.65% Sensitivity = 94.12%	Total images 340
[21]	The chromatic moment	Neural network	Texture feature is neglected. Too few samples	Specificity = 84.68 ± 1.80 Sensitivity = 92.97 ± 1.05	100 images
[22]	LBP histogram	Multi-layer perceptron (MLP) and SVM	Too few samples for training	Accuracy = 92.37%, Specificity = 91.46%, Sensitivity = 93.28%	100 images
[23]	Dif lac analysis	De-noising using Bi-dimensional ensemble empirical mode decomposition (BEEMD)	Too few samples for training	Mean accuracy >95%	176 images
[24]	Texture and colour	Vector supported convex hull method	Specificity is less. Skewed data	Recall = 0.932 Precision = 0.696 Jaccard index = 0.235	36 images
[25]	Leung and Malik (LM) and LBP	k-nearest neighbor (k-NN)	Computationally intense. Skewed data	Recall = 92% Specificity = 91.8%	1750 images

This study proposes a CAD system for ulcer detection in CE using optimized feature set. Major contributions to this work are:

- Data reduction technique
- Automated ulcer detection using an optimized feature set
- A thorough comparative analysis of the our designed feature selection technique with other techniques
- A thorough analysis of the performance of designed system with other systems.

2 Materials and Models

2.1 Proposed System

This section explains the detailed significance of each stage of the designed CAD system. Following is the procedure of the entire system:

- (a) Load CE images
- (b) Perform noise removal
- (c) Perform image enhancement
- (d) Extract features
- (e) Reduce feature vector proposed data reduction technique
- (f) Partition data into training and testing set
- (g) Train the classifier model
- (h) Classify test data using the trained classifier model

Figure 4 presents a brief idea of the proposed system.

2.2 Pre-processing

The image enhancement technique is used to utilize all the details present in the image. Image enhancement provides a better perception for human visualization and better input for CAD systems [26]. Pre-processing noticeable improves the computational efficiency and overall detection rate of the system. CE images suffer from low contrast [27]. For digital images, the simple definition of contrast is the difference between the maximum and minimum pixel intensity. Figure 5 shows methodology to remove existence noise and enhance input image:

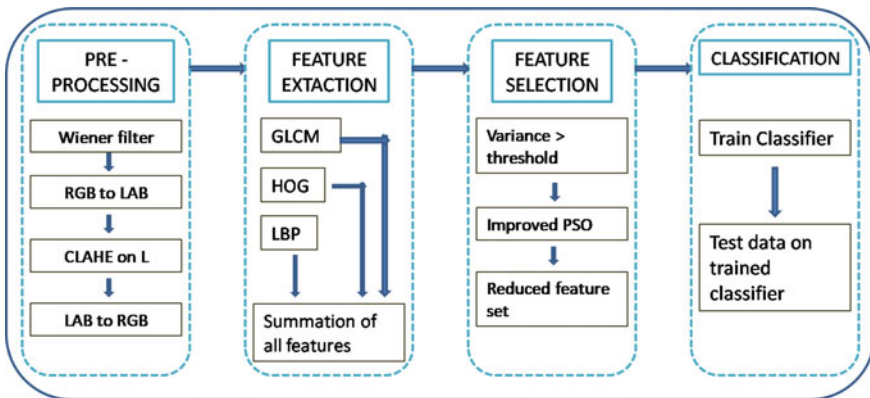
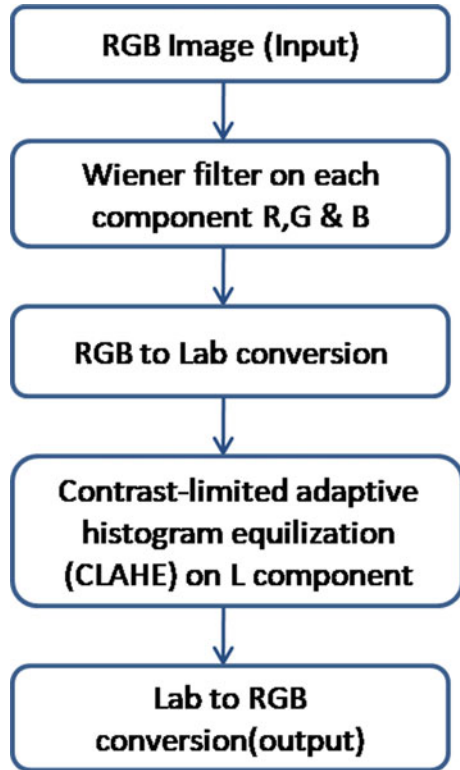

Fig. 4 Brief idea of the system for automatic detection of ulcer

Fig. 5 Pre-processing methodology



The Wiener filtering is used for noise smoothing. It performs linear estimation of local mean and variance of pixels in the actual image and minimizes the overall error. For enhancement of the given image, contrast-limited adaptive histogram equalization (CLAHE) is used after smoothing by Wiener filter. Instead of the whole image, CLAHE functions on small areas in the given image. It calculates the contrast transform function for each region individually. The bilinear interpolation is used to merge nearby regions to eliminate artificially induced boundaries. By this technique, the contrast of the image is limited while avoiding the amplification of the noise. Since CE images are prone to illumination related problems and low contrast, CLAHE is applied only on the L component of Lab color space for better enhancement. Finally, the image is converted back to RGB and passed for post-processing. Figure 6 shows the sample output of this stage.

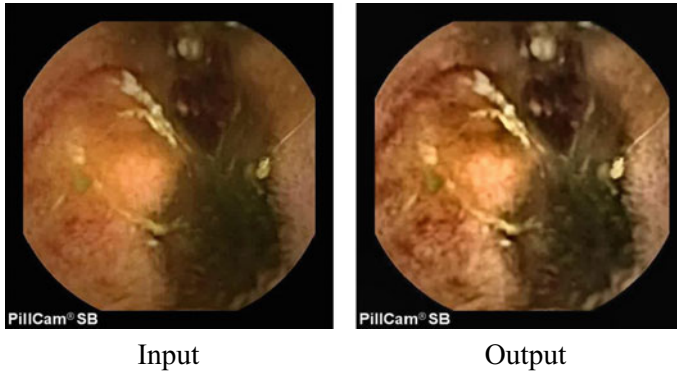

Fig. 6 Sample output of pre-processing

2.3 *Extraction of Features*

Three different features are included in this study. Local binary pattern (LBP), gray-level co-occurrence matrix (GLCM) and the Histogram of oriented gradients (HOG) together forms the feature set. Ulcer in CE images exhibits very discriminative texture and color properties. GLCM is a statistical method. It is helpful for analyzing textures. This study utilizes 13 texture features computed from GLCM namely homogeneity, contrast, mean, correlation, energy, standard deviation, skewness, root mean square (RMS), variance, entropy, smoothness, kurtosis and inverse difference moment (IDM). Energy measures uniformity. Entropy is a measure of complexity and it is large for non-uniform images. Energy and Entropy are inversely and strongly correlated. Variance is a measure of non-uniformity. Standard deviation and variance are strongly correlated. IDM is a measure of similarity. When all the elements in the image are same, IDM reaches its maximum value.

HOG as a feature descriptor deals with ambiguities related to texture and color [28]. Distribution (histogram) of intensity gradients can better describe the appearance of object and shape within the image. HOG identifies the edges [29]. It is computed for every pixel after dividing the image into cells. All the cells within a block are normalized, and concatenation of all these histograms is the feature descriptor. Figure 7 shows a sample CE image and visualization of the HOG descriptor.

LBP is a very discriminative textural feature [30]. CE images exhibits high variations related to illumination due to limited illumination capacity, limited range of vision inside GIT and motion of the camera. It is learned that LBP performs robustly to illumination variations. A total of 256 patterns are obtained from a 3×3 neighborhood. Texture feature descriptor is the LBP histogram of 256 bin occurrence calculated over the region. A novel rotation invariant LBP is proposed in [30]. Patterns are uniform if they contain at most two transitions on a circular ring from 0 to 1 or 1 to 0. Examples of uniform patterns are 11111111 (nil transitions), 01000000 (2 transitions).

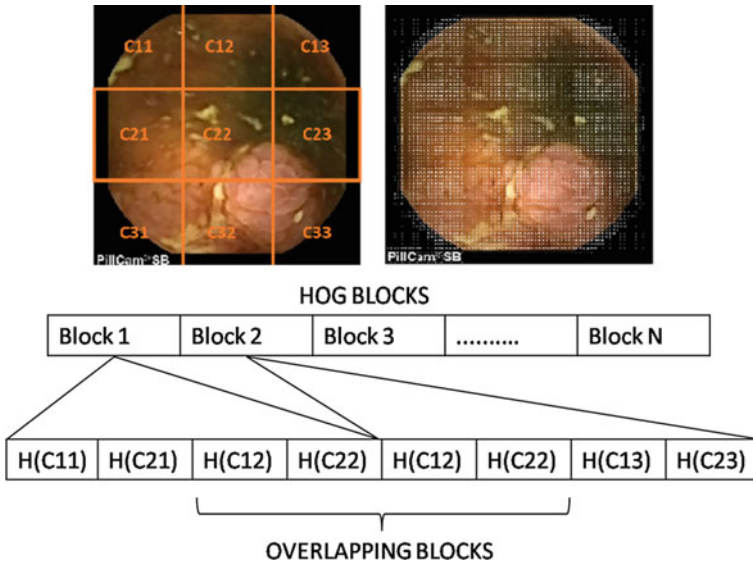

Fig. 7 Sample CE image and HOG descriptor visualization

2.4 Feature Selection

The optimal size of the feature set reduces the cost of recognition as well as lead to improvement in accuracy of classification [31]. We compute 13 features from GLCM, HOG feature extraction process yields 181476 features, and LBP feature extraction leads to 59 features. Total of 181548 features is extracted from each of CE image in the dataset. Needless to say that this feature set produces extraordinary results for ulcer classification but, we must limit the number of features to a considerable number. To decrease the size of feature set and maintain the performance of classification, this study proposes a novel feature selection technique. Features with high variance can easily discriminate between two classes but, variance alone is not a good measure of information. Any two features can exhibit high variance but they may be correlated. Therefore, the proposed feature selection technique is designed on a dual criterion: high variance and low co-relation. Proposed feature selection technique is termed as high variance low co-relation (HVLC) technique. HVLC technique reduces the obtained feature set by 98.34% to 3000 number of features. Proposed technique encompasses a minimum co-relation fitness function based particle swarm optimization (PSO). This technique finds the optimal solution. It is influenced by local and global best values. Here, pbest is the best value of a particle and gbest is the best value of the whole swarm. At each iteration, ith particle updates position P as per (1) and velocity V as per (2).

$$P_i(t + 1) = P_i(t) + V_i(t) \tag{1}$$

Table 2 Data reduction algorithm

```

Initial feature-set  $S = [1, 2, \dots, n]$ 
Set threshold  $T$ 
Final feature set  $F_s = \text{null}$ 
Choose features with variance  $> T$ 
Surviving feature set  $S_s = [1, 2, \dots, m]$  where  $m < n$ 
Set  $k = \text{size of } F_s \text{ from within } S_s \text{ such that}$ 
classification error  $\text{err}$  is very small
Set values of PSO control parameters:  $w = 0.2, c1 = c2 = 2$ 
Create and initialize particles with values of  $P$  and  $V$ ; initialize  $g_{\text{best}}$  of the population as infinity
Repeat:
For  $\text{itr} = 1$  to population
Compute correlation  $C$  as a ranking criteria
 $f = \text{argmin}(C)$ 
EndFor
Update  $p_{\text{best}} = \min(f)$ 
Update  $g_{\text{best}} = \min(g_{\text{best}}, p_{\text{best}})$ 
Update  $P$  using (1)
Update  $V$  using (2)
Until the termination criterion is satisfied
Return improved-PSO selected values
Final reduced features  $F_F = [1, 2, 3, 4, 5, \dots, k]$  where  $k < m$ 

```

$$V_i(t + 1) = wV_i(t) + c1 * \text{rand}([0, 1]) * (p_{\text{best}} - P_i(t)) + c2 * \text{rand}([0, 1]) * (g_{\text{best}} - P_i(t)) \quad (2)$$

Where, t and $(t + 1)$ are two successive iterations, inertia weight w , cognitive coefficient $c1$, and social coefficient $c2$ are constants. Also, $c1$ and $c2$ control the magnitude of steps taken by particle towards p_{best} (personal) and g_{best} (global) respectively. Table 2 presents the data reduction algorithm.

The variance threshold is experimentally chosen to fit the application. These features are then fed to SVM classifier to classify between ulcer and normal images.

2.5 Classification

Ulcer detection in CE is a binary classification problem having exactly two classes namely ulcer and normal. The SVM develops the widest possible hyperplane that can explicitly separate samples of two different classes. The support vectors are the

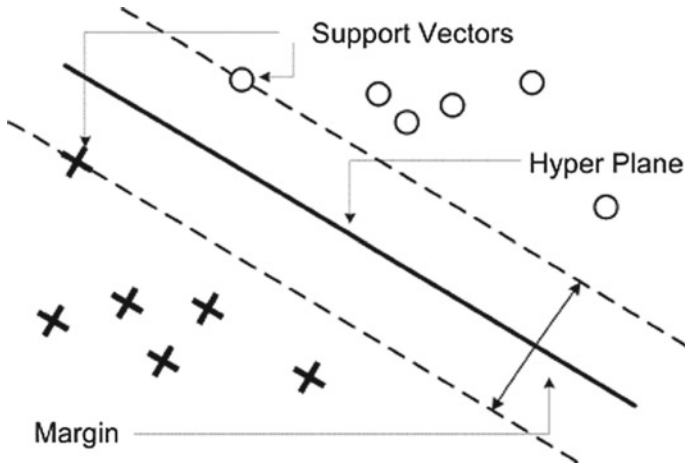

Fig. 8 The concept of SVM [32]

observations falling on the boundary of the slab parallel to the hyperplane. Figure 8 presents the concept of SVM.

The subsequent section presents detailed result analysis of the performance of the proposed system.

3 Results Analysis and Discussion

3.1 Dataset

Total of 1200 images from CE videos [33] is extracted out of which 201 images are of ulcers, and 999 images are normal. The dimension of each image is 576×576 pixels. All the images were manually diagnosed and annotated by physicians providing the ground truth. To avoid imbalanced data and overfitting 100 ulcer images and 100 normal images are carefully chosen from the annotated dataset.

3.2 Performance Metrics

Performance metrics used in this study are derived from a confusion matrix. Detailed discussion on the confusion matrix is given below (Table 3).

Accuracy: The accuracy is measure of capability of a system to identify samples correctly.

$$\text{Accuracy} = (\text{TN} + \text{TP}) / (\text{TN} + \text{TP} + \text{FN} + \text{FP}) \tag{3}$$

Precision: The precision is a measure of probability of correct classification of an observation.

$$\text{Precision} = [\text{TP} / (\text{FP} + \text{TP})] \tag{4}$$

Sensitivity: Sensitivity is a measure of probability of system to provide a result that is true positive.

$$\text{Sensitivity} = \text{TP} / \text{TP} + \text{FN} \tag{5}$$

Specificity: Specificity is a measure of probability of system to classify a positive observation as a negative.

$$\text{Specificity} = \text{FP} / \text{TN} + \text{FP} \tag{6}$$

F-measure: The harmonic average of the precision and sensitivity is given by this metric. The value 100 indicates perfect system and 0 indicates worst system.

$$F - \text{measure} = 2 * (\text{Precision} * \text{Sensitivity}) / (\text{Precision} + \text{Sensitivity}) \tag{7}$$

Matthews correlation coefficient (MCC): It is used even when the size of classes varies largely [34]. MCC in case of binary classifiers in machine learning is a measure of the quality.

$$\text{MCC} = [(\text{TN} * \text{TP}) - (\text{FN} * \text{FP})] / \text{SQRT}[(\text{FP} + \text{TP})(\text{FN} + \text{TP})(\text{FP} + \text{TN})(\text{FN} + \text{TN})] \tag{8}$$

The system is implemented on Dell Optiplex 9010 desktop computer with processor—intel core i7 and RAM—6 GB using MATLAB R2017a.

Table 3 Structure of the confusion matrix

Observer versus classifier		Prediction of classifier	
		+	−
Actual observation	+	True-Positive [TP]	False-Negative [FN]
	−	False-Positive [FP]	True-Negative [TN]

Table 4 A comparison of proposed feature selection

Method	Accuracy	Sensitivity	Specificity	Precision	F measure	MCC
Relief F	93.7	87.5	100	100	93.3	88.19
Fisher score	91.66	90	93.3	93.10	91.5	83.37
Laplacian score	91.66	83.33	100	100	90.9	84.51
Proposed (HVLC)	95	95	95	95	95	90

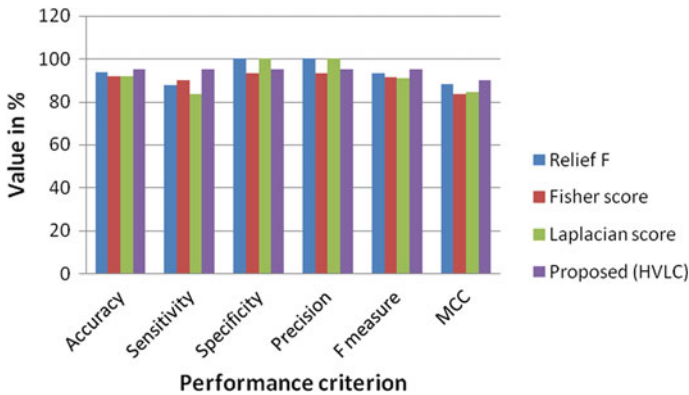

Fig. 9 Performance comparison of feature selection techniques

3.3 Analysis of Results

The achievement of the automated ulcer detection system largely depends on the achievement of the proposed feature selection technique. Therefore the performance of the proposed method is thoroughly compared with three other feature selection methods namely relief F [35], Fisher score [36] and Laplacian score [37]. Relief F gives a weight to a feature on the basis of the distance between observed feature and given feature. It finally provides a rank of most suitable features. Fisher score ranks each feature based on Fisher criterion. Laplacian score based feature ranking exhibits power to preserve locality. Table 4 shows a comparison of the proposed feature selection technique with three different techniques and Fig. 9 presents the graphical representation of the same.

As presented by Fig. 9, feature set obtained by the proposed HVLC technique outperforms in accuracy, sensitivity, f measure, and MCC as compared to three other techniques. Further, the ulcer detection system is compared with two other systems. Suman et al. [3] extracted features from relevant color bands and ulcer images are classified using SVM. Koshy and Gopi [38] extracted contourlet transform and log Gabor based texture features and the classification task is performed using SVM. We have implemented both these prior art on our hardware and using our dataset. The

Table 5 A comparison of the proposed system

Method	Accuracy	Sensitivity	Specificity	Precision	F measure	MCC
[3]	80	60	100	100	75	65.5
[38]	88.75	77.5	100	100	87.3	79.5
Proposed	95	95	95	95	95	90

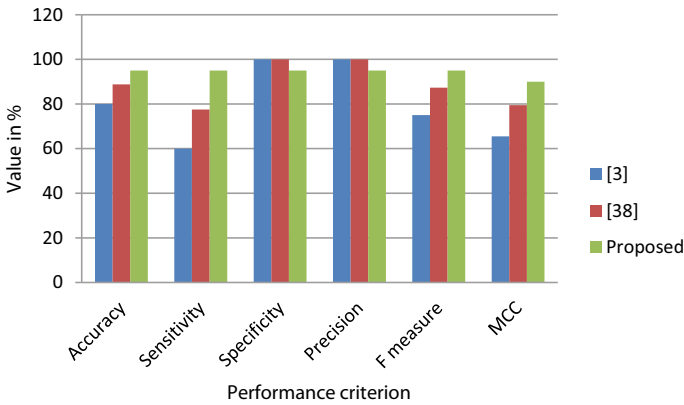

Fig. 10 Performance comparison of CAD systems

comparative results presented in Table 5 shows that the proposed system outperforms the prior art. Figure 10 presents a graphical analysis of the result.

As seen in Fig. 10, the proposed CAD system for ulcer detection in CE outperforms the other two systems in terms of accuracy, sensitivity, F measure, and MCC. However, it fails to outperform other systems in terms of specificity and precision. Reason for this is that the proposed systems have more false positives as compared to other systems. Approximately 5% of normal cases are misclassified as ulcer cases by the proposed system as compared to the other two systems.

4 Conclusion

With the advancements in the field of multimedia and IoT, the data generation has increased tremendously. This study focuses on the data reduction of one of the emerging medical imaging systems, capsule endoscopy. With advanced imaging system, CE generates a massive number of images with minute details. It is important for a CAD system to preserve minute details of a CE image and thereby provide a precise diagnosis. This study addresses the dilemma of reducing data while preserving crucial information. The proposed data reduction technique reduces the feature vector from 181548 to 3000 for each image. It reduces data by 98.34% and yet the proposed system outperforms when compared with other data reduction techniques and sys-

tems. The significant reduction in the size of data certainly reduces computational time and memory.

References

1. A. Kumari, S. Tanwar, S. Tyagi, N. Kumar, M. Maasberg, K.-K.R. Choo, Multimedia big data computing and Internet of Things applications: a taxonomy and process model. *J. Netw. Comput. Appl.* [Internet] **124**, 169–195 (2018), <https://linkinghub.elsevier.com/retrieve/pii/S1084804518303011>
2. S. Charfi, Ansari M. El, Computer-aided diagnosis system for colon abnormalities detection in wireless capsule endoscopy images. *Multimed. Tools Appl.* **77**(3), 4047–4064 (2018)
3. S. Suman, F.A. Hussin, A.S. Malik, S.H. Ho, I. Hilmi, A.H.-R. Leow, et al., Feature selection and classification of ulcerated lesions using statistical analysis for WCE images. *Appl. Sci.* **7**(10) (2017)
4. S. Tanwar, P. Patel, K. Patel, S. Tyagi, N. Kumar, M.S. Obaidat, An advanced Internet of Thing based security alert system for smart home, in *IEEE CITS 2017: 2017 International Conference on Computer, Information and Telecommunication Systems* (2017), pp. 25–29
5. Capsule image 1 [Internet]. [cited 2018 Mar 6], <https://commons.wikimedia.org/w/index.php?curid=819896>
6. Capsule image 2 [Internet]. [cited 2018 Mar 6], <https://www.ecnmag.com/article/2012/02/reducing-size-while-improving-functionality-and-safety-next-generation-medical-device-design>
7. G. Liu, G. Yan, S. Kuang, Y. Wang, Detection of small bowel tumor based on multi-scale curvelet analysis and fractal technology in capsule endoscopy. *Comput. Biol. Med.* [Internet] **70**, 131–138 (2016). <http://dx.doi.org/10.1016/j.combiomed.2016.01.021>
8. Q. Zhao, G.E. Mullin, M.Q.H. Meng, T. Dassopoulos, R. Kumar, A general framework for wireless capsule endoscopy study synopsis. *Comput. Med. Imaging Graph* [Internet] **41**, 108–116 (2015). <http://dx.doi.org/10.1016/j.compmedimag.2014.05.011>
9. A. Srivastava, S.K. Singh, S. Tanwar, S. Tyagi, Suitability of big data analytics in Indian banking sector to increase revenue and profitability, in *Proceedings of 2017, 3rd International Conference on Advances in Computing Communication & Automation (Fall), ICACCA 2017*, 1–4 January 2018 (2018), pp. 1–4
10. A. Kumari, S. Tanwar, S. Tyagi, N. Kumar, Fog computing for Healthcare 4.0 environment: opportunities and challenges. *Comput. Electr. Eng.* [Internet] **72**, 1–13 (2018). <https://doi.org/10.1016/j.compeleceng.2018.08.015>
11. N.I.R. Yassin, S. Omran, E.M.F. El Houbay, H. Allam, Machine learning techniques for breast cancer computer aided diagnosis using different image modalities: a systematic review. *Comput. Methods Programs Biomed.* [Internet] **156**, 25–45 (2017), <http://linkinghub.elsevier.com/retrieve/pii/S0169260717306405>
12. R. Srivastava, S. Srivastava, Restoration of Poisson noise corrupted digital images with non-linear PDE based filters along with the choice of regularization parameter estimation. *Pattern Recognit. Lett.* [Internet] **34**(10), 1175–1185 (2013). <http://dx.doi.org/10.1016/j.patrec.2013.03.026>
13. V.S. Kodogiannis, M. Boulougoura, J.N. Lygouras, I. Petrounias, A neuro-fuzzy-based system for detecting abnormal patterns in wireless-capsule endoscopic images. *Neurocomputing* **70**(4–6), 704–717 (2007)
14. B. Li, M.Q.H. Meng, Wireless capsule endoscopy images enhancement via adaptive contrast diffusion. *J. Vis. Commun. Image Represent* [Internet] **23**(1), 222–228 (2012). <http://dx.doi.org/10.1016/j.jvcir.2011.10.002>
15. M. Mackiewicz, J. Berens, M. Fisher, Wireless capsule endoscopy color video segmentation. *IEEE Trans. Med. Imaging* **27**(12), 1769–1781 (2008)

16. Y. Lan, X. Zhang, Z. Liu, L. Zhao, M. Li, Hybrid segmentation using region information for wireless capsule endoscopy images. *Inf. Technol. J.* **12**(16), 3815–3819 (2013)
17. Y. Shen, P.P. Guturu, B.P. Buckles, Wireless capsule endoscopy video segmentation using an unsupervised learning approach based on probabilistic latent semantic analysis with scale invariant features. *IEEE Trans. Inf. Technol. Biomed.* [Internet] **16**(1), 98–105 (2012), <http://www.ncbi.nlm.nih.gov/pubmed/22010158>
18. X. Jiang, Feature extraction for image recognition and computer vision, in *Proceedings of 2009, 2nd IEEE International Conference on Computer Science and Information Technology ICCSIT 2009* (2009), pp. 1–15
19. A. Karargyris, N. Bourbakis, Detection of small bowel polyps and ulcers in wireless capsule endoscopy videos. *IEEE Trans. Biomed. Eng.* **58**(10 PART 1), 2777–2786 (2011)
20. Y. Yuan, J. Wang, B. Li, M.Q.H. Meng, Saliency based ulcer detection for wireless capsule endoscopy diagnosis. *IEEE Trans. Med. Imaging.* **34**(10), 2046–2057 (2015)
21. B. Li, M.Q.H. Meng, Computer-based detection of bleeding and ulcer in wireless capsule endoscopy images by chromaticity moments. *Comput. Biol. Med.* **39**(2), 141–147 (2009)
22. B. Li, M.Q.H. Meng, Texture analysis for ulcer detection in capsule endoscopy images. *Image Vis. Comput.* [Internet] **27**(9), 1336–1342 (2009). <http://dx.doi.org/10.1016/j.imavis.2008.12.003>
23. V.S. Charisis, L.J. Hadjileontiadis, C.N. Liatsos, C.C. Mavrogiannis, G.D. Sergiadis, Capsule endoscopy image analysis using texture information from various colour models. *Comput. Methods Programs Biomed.* [Internet] **107**(1), 61–74 (2012). <http://dx.doi.org/10.1016/j.cmpb.2011.10.004>
24. P. Szczypiński, A. Klepaczko, M. Pazurek, P. Daniel, Texture and color based image segmentation and pathology detection in capsule endoscopy videos. *Comput. Methods Programs Biomed.* **113**(1), 396–411 (2014)
25. R. Nawarathna, J. Oh, J. Muthukudage, W. Tavanapong, J. Wong, P.C. de Groen, et al., Abnormal image detection in endoscopy videos using a filter bank and local binary patterns. *Neurocomputing* [Internet] **144**, 70–91 (2014), <http://linkinghub.elsevier.com/retrieve/pii/S0925231214007334>
26. S.I. Sahidan, M.Y. Mashor, A.S.W. Wahab, Z. Salleh, H. Ja'afar, Local and global contrast stretching for color contrast enhancement on Zehl-Nelsen tissue section slide images. in *IFMBE Proc. 2008*, vol. 21, no. 1 (IFMBE, 2008), pp. 583–586
27. M. Moradi, A. Falahati, A. Shabbahrami, R. Zare-Hassanpour, Improving visual quality in wireless capsule endoscopy images with contrast-limited adaptive histogram equalization, in *2015 2nd International Conference Pattern Recognition and Image Analysis IPRIA 2015* (2015), pp. 0–4
28. Y.J. Cho, S.H. Bae, K.J. Yoon, Multi-classifier-based automatic polyp detection in endoscopic images. *J. Med. Biol. Eng.* **36**(6), 871–882 (2016)
29. N. Dalal, W. Triggs, Histograms of oriented gradients for human detection, in *2005 Conference on Computer Vision & Pattern Recognition CVPR 2005* [Internet], vol. 1, no. 3 (IEEE Computer Society, 2004), pp. 886–893, <http://eprints.pascal-network.org/archive/00000802/>
30. T. Ojala, M. Pietikäinen, T. Mäenpää, Multiresolution gray-scale and rotation invariant texture classification with local binary patterns. *IEEE Trans. Pattern Anal. Mach. Intell.* **24**(7), 971–987 (2002)
31. A. Jain, D. Zongker, Feature Selection: Evaluation, Application, and Small Sample Performance. *IEEE Trans. Pattern Anal. Mach. Intell.* [Internet] **19**(2), 153–158 (1997), <http://ieeexplore.ieee.org/lpdocs/epic03/wrapper.htm?arnumber=574797>
32. D. Tao, X. Tang, X. Wu, Asymmetric bagging and random subspace for support vector machines-based relevance feedback in image retrieval. *IEEE Trans. Pattern Anal. Mach. Intell.* **28**(7), 1088–1099 (2006)
33. E. Spyrou, D.K. Iakovidis, Video-based measurements for wireless capsule endoscope tracking. *Meas. Sci. Technol.* **25**(1) (2014)
34. V.P. Singh, R. Srivastava, Improved image retrieval using fast Colour-texture features with varying weighted similarity measure and random forests. *Multimed. Tools Appl.* 1–26 (2017)

35. I. Kononenko, E. Šimec, M. Robnik-Šikonja, Overcoming the myopic of inductive learning algorithms with RELIEFF. *Appl. Intell.* [Internet] **7**(1), 39–55 (1997), <http://citeseer.nj.nec.com/kononenko97overcoming.html>
36. Q. Gu, Z. Li, J. Han, Generalized Fisher Score For Feature Selection (2005)
37. B. Liao, Y. Jiang, W. Liang, W. Zhu, L. Cai, Z. Cao, Gene selection using locality sensitive Laplacian score. *IEEE/ACM Trans. Comput. Biol. Bioinforma.* **11**(6), 1146–1156 (2014)
38. N.E. Koshy, V.P. Gopi, A new method for ulcer detection in endoscopic images, in *2nd International Conference on Electronics and Communication Systems ICECS 2015* (2015), pp. 1725–1729

Part III
Societal Impact of Multimedia Big Data

Multimedia Social Big Data: Mining



Akshi Kumar, Saurabh Raj Sangwan and Anand Nayyar

Abstract The rapid evolution and adoption of the SMAC (Social media, Mobile, Analytics and Cloud) technology paradigm, has generated massive volumes of human-centric, real-time, multimodal, heterogeneous data. Human-sourced information from social networks, process-mediated data from business systems and machine-generated data from Internet-of-Things are the three primary sources of big data which define the richness and scale of multimedia content available. With the proliferation of social networks (Twitter, Tumblr, Google+, Facebook, Instagram, Snapchat, YouTube, etc.), the user can post and share all kinds of multimedia content (text, image, audio, video) in the social setting using the Internet without much knowledge about the Web's client-server architecture and network topology. This proffer novel opportunities and challenges to leverage high-diversity multimedia data in concurrence to the huge amount of social data. In recent years, multimedia analytics as a technology-based solution has attracted a lot of attention by both researchers and practitioners. The mining opportunities to analyze, model and discover knowledge from the social web applications/services are not restricted to the text-based big data, but extend to the partially unknown complex structures of image, audio and video. Interestingly, the big data is estimated to be 90% unstructured further, making it crucial to tap and analyze information using contemporary tools. The work presented is an extensive and organized overview of the multimedia social big data mining and applications. A comprehensive coverage of the taxonomy, types and techniques of Multimedia Social Big Data mining is put forward. A SWOT Analysis is done to understand the feasibility and scope of social multimedia content and big data analytics is also illustrated. Recent applications and suitable directions for

A. Kumar · S. R. Sangwan
Department of Computer Science & Engineering, Delhi Technological University,
New Delhi, India
e-mail: akshikumar@dce.ac.in

S. R. Sangwan
e-mail: saurabhsangwan2610@gmail.com

A. Nayyar (✉)
Graduate School, Duy Tan University, Da Nang, Vietnam
e-mail: anandnayyar@duytan.edu.vn

future research have been identified which validate and endorse this correlation of multimedia to big data for mining social data.

Keywords Big data · Social data · Web mining

1 Introduction to Multimedia Social Big Data Mining

The unceasing surge of the World Wide Web and the acquaintance of the people around the world with the Internet create all the required prerequisites for a wide-ranging adaptation of the elementary Internet as a general medium for exchange of information, where any user can become a contributor. This new collaborative Web (called Web 2.0) resiliently defines the techno-social system which augments human cognition, communication, and co-operation; where cognition is the necessary prerequisite to communicate and the precondition to co-operate. In other words, cooperation needs communication and communication needs cognition. Such complex social big data (human-sourced, process-mediated and device generated) calls for cross disciplinary research from data mining, machine learning, pervasive and ubiquitous computing, networking, and computational social science.

The term “Big Data” is of huge importance today for researchers and practitioners alike. It is defined as ‘*high-volume, high-velocity and high-variety information assets that demand cost-effective, innovative forms of information processing for enhanced insight and decision making*’. Big Data is used to denote a collection of data sets which are too large and complex to handle and process using conventional data processing tools and applications. The size of data sets cannot be handled by common software tools used to for capturing, curating, managing and processing data within an acceptable time limit. The characteristics of Big Data are described by 7 V’s given in the following Table 1.

Big Data is a trending set of techniques that demand new ways of consolidation of various methods to uncover hidden information from the massive and complex raw supply of data. User-generated content on the Web has been established as a type of big data and thus the discussion on Big data is inevitable in any description of the evolution of Web and its growth. Following are the types of Big Data that have been identified across the literature:

- **Social Networks (human-sourced information):** Almost all of the data and information generated by people today is digitized and can be stored on any device from PCs to social websites. Such data is usually not structured and not governed by anyone. Data generated from social media platforms like Facebook, Blog posts and comments, Personal documents, Pictures from Instagram, Flickr, etc., and Videos from YouTube, E-mail, Web search results and content from mobile phones: text messages amongst others.
- **Traditional Business systems (process-mediated data):** Business events like customer registration, product-manufacturing, placing and taking orders, etc. are

Table 1 Big-data Characteristics

<p>Volume Scale of data</p>	<p>It determines the amount of data that flows in, which can be stored and originated further. Depending on the amount of data that is stored, it is decided whether it can fall in the category of “big data” or not</p>
<p>Variety Different forms of data</p>	<p>Different type and various sources of data are specified including both structured and unstructured data. For e.g. documents, emails, images, videos, audio etc.</p>
<p>Velocity Analysis of Streaming data</p>	<p>It is the aspect which deals with the pace of the data in motion and its analysis where the content flow is assumed to be continuous and immense. Apart from the consideration of the speed of the input, it also contemplates the celerity of the generation of useful information from it</p>
<p>Veracity Uncertainty of data</p>	<p>This characteristic of big data deals with the primary issue of reliability and whether the analysis of data is being accurately done, so that eventually there is a production of credible and quality solutions</p>
<p>Variability Contextual meaning of data</p>	<p>It refers to the inconsistency of the information that is stored. In simpler words, it deals with rapidly changing and alternative meanings that are associated with the data</p>
<p>Visualization Way to represent information/data</p>	<p>Visualization happens to make one of the crucial characteristics of big data because all the data that is being stored used as an input and generated as a result, needs to be sorted and viewed in a manner that is easy to read and comprehend</p>
<p>Value Cost of using data</p>	<p>It deals with the practice of retrieving the usefulness of the data. It is perceived that data in its original self won't be valuable at all. Under analysis, how data is turned into knowledge and information is what the “value” characteristic deals with</p>

recorded and monitored by these. Such data include data from transactions, tables of references, relations, etc. and is quite structured. Data generated by Public organizations like Medical records and Data from Commercial transactions, Bank and stock records, E-commerce and credit/debit cards etc. are some examples.

- **Internet of Things (machine-generated data):** This includes data generated by the huge number of sensors and machines that are used for measuring and recording the events in the real world. The data from sensors is well structured as it is machine-generated, and range from simple sensor records to complex computer

logs. Data from fixed sensors like home automation, weather/pollution sensors, traffic sensors/webcam and security/surveillance videos/images, data from mobile sensors (tracking) such as mobile phone location, cars and satellite images and data from computer systems such as logs and web logs are some examples.

Business innovation and social intelligence pave the way to a future in which smart factories, intelligent machines, networked processes and big data are brought together to foster industrial growth and shift the economics. Social media has emerged as a key player which provides a platform for expression and distribution of content in today's world. The primary intent of social networking sites is to create, professional, interest, relationship-based virtual communities, enabling stronger connections with everyone around the world. Social media content is one of the major data sections which have attracted people and organizations across the globe. This is primarily due to the omnipresence and coverage of social applications world-wide. Social Media applications allow users to share comments, opinions, ideas, and media with friends, family, businesses, and organizations [1]. The data contained in these comments, ideas, and media are valuable to many types of organizations. Moreover, social media is inherently an informal way of communication with all kinds of multimedia content.

Social media dynamics keep changing with respect to the increasing user base and user-activity which makes it a high dimensional, complex and fuzzy data space for analytical processing. Thus, social big data mining contributes significantly to the field of data analytics as a new technology-based solution to comprehend wider and deeper applications of social media data. The maturity and growth of data science and machine learning for real-time decision making are the key technology drivers supporting viable, competent, and an actionable business model.

Social Media is one of the largest contributors to big data. With the increasing number of social media platforms and the rapid increase in the number of users of these platforms, huge amounts of data are generated around the world by the minute. Facebook, Twitter, Instagram and YouTube are some of the prominent contributors to social media. Analyzing the data from these websites would not only improve decisions, but would also lead to cost reduction and new products and services better suited to the needs of the users. The following Fig. 1 depicts the role of social big-data analytics in a typical business setting.

The following Fig. 2 depicts the existence of multimedia social big data in a typical business setting.

Variety and velocity are two key terms associated with big data. There are various sources of big data. Clickstream data, data from various electronic devices like sensors, social media platforms like Facebook, Twitter, LinkedIn, Instagram, Google+ tremendously contribute a variety of data apart from text like images, videos and audios. Geo-spatial data sharing people's locations feeds from business companies, markets and even those related to government are increasing day by day. Web 2.0 including data from mobiles, e-commerce websites like Amazon, Flipkart, eBay, recommendations as well business and marketing data and data from Enterprise Resource Planning and Customer Relationship Management like bills and data about stocks and inventory are subsets that contribute towards big data.

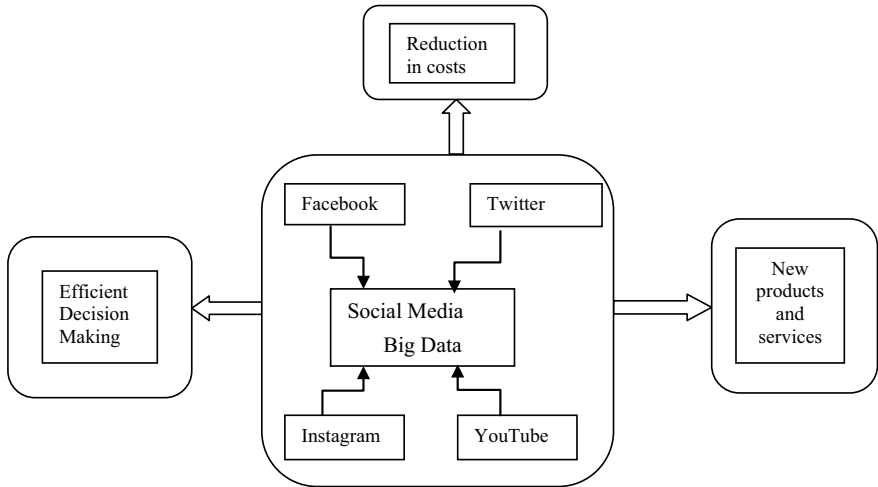

Fig. 1 Social big-data analytics in business

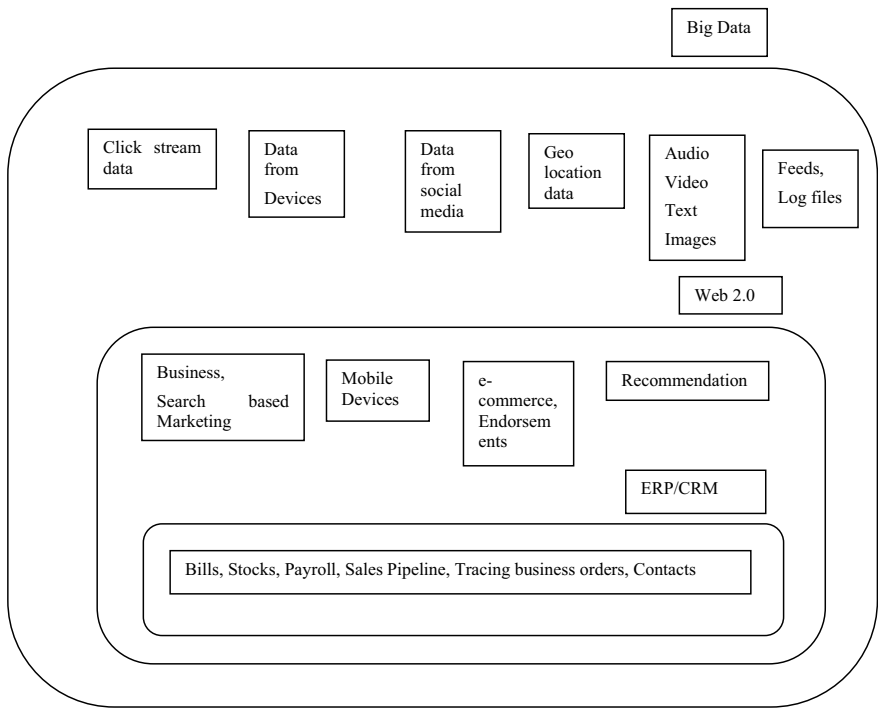

Fig. 2 Multimedia social big data in business

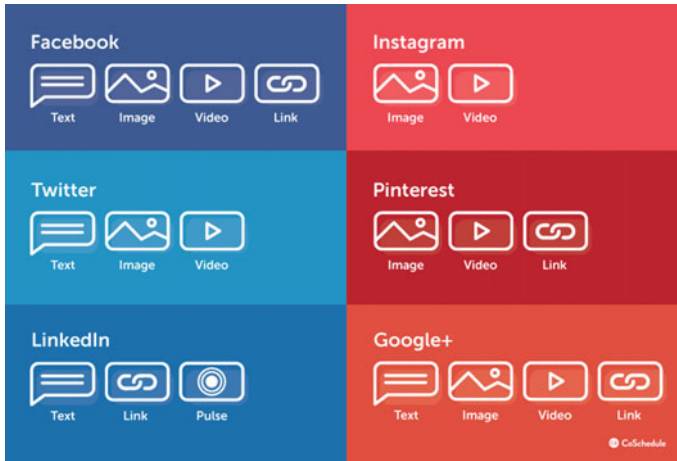

Fig. 3 Multimedia support by popular social networking sites

Recently, visual communication using images to express views, opinions, feelings, emotions and sentiments has increased tremendously on social platforms like Flickr, Instagram, Twitter, Tumblr, etc. [2–5]. Images are particularly powerful as they have cognition associated and visual experiences convey sentiments and emotions better. Consequently, the visual sentiment analysis has been of interest to researchers and it has been observed that deep learning techniques have outperformed the conventional machine learning techniques in analyzing the visual sentiment. Multimodal capabilities offered by popular social networking websites such as Facebook, Twitter, and Tumblr have further enabled mix of text and images in a variety of ways for better social engagement. The ascendant use of infographics, typographic-images, memes and GIFs in social feeds is a testimony to this. Text-driven analytics has been widely studied [6–9] and few pertinent studies which report visual analytics of images are available in literature [10–14]. Moreover, much of the reported work has analyzed a single modality data, whereas multiple modalities of text and image remain unexplored. The following Fig. 3 depicts the multimedia types supported by popular social networking sites.

The following Table 2 lists out the media types supported by popular social media platforms.

2 Process Model for Multimedia Social Big Data Mining

Big Data is a term used to describe data that is huge in amount and which keeps growing with time. Big Data consists of structured, unstructured and semi-structured data. This data can be used to track and mine information for analysis or research purpose.

Table 2 Popular social media characteristics

Social media platform	Multimedia supported	Characteristics
Facebook	Text, images, videos, links	Timeline, wall, events, status, embed-in posts, social plug-ins
Twitter	Text, images, videos	Pinning tweets, advanced search, Twitter moments, customized tweet alerts
LinkedIn	Text, links, pulse	Keep in touch, Get help, search for jobs, hire new employees
Instagram	Images, videos	Live Videos, Stories, Push notifications, Filters
Pinterest	Images, videos, links	Article Pins, Ad groups, Lens, Shop the Look, Pinterest e-mail, Native Video, Cinematic Pins
Google+	Text, images, videos, links	Google+ circles, authorship, hangouts, communities, events, Insights, My Business

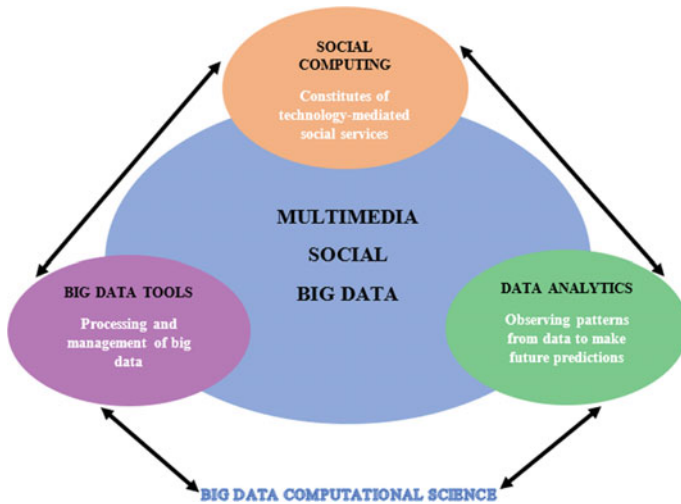

Fig. 4 Big data aspects

Big data and analytics together can not only be helpful in determining primary reasons for loss in businesses, but can also be used for analyzing trends in sales on the basis of customer buying history. It can also be helpful in determining fraudulent behavior and thus helps in reducing potential risks for organizations. Figure 4 represents Big data and its various aspects.

Big data contain complex and huge datasets thus making it difficult to process it using conventional tools and software. Multimedia social big data encompasses a variety of data and it is challenging to process and manage such data especially

related to its volume and complexity. A few important challenges for multimedia big data are:

- Structuring the unstructured data.
- Understand and capture most important data eradicating irrelevant and redundant data.
- Storing the huge amount of data that is growing day by day.

Some of the tools used for storage and analysis of big data are Apache Hadoop; Microsoft HDInsight; Hive; Sqoop; PolyBase; Presto.

Another important aspect of social big data is Social Computing. Social Computing is a research domain that helps us in understanding social behaviors. It is concerned with the intersection of social behavior and computational systems and deals with the mechanisms through which people interact with computational systems [15]. Some examples where social computing has helped in research in recent times is given as follows:

- Researchers have looked at how people behave in various online communities (such as Subreddits, Yikyak, etc.).
- What kind of users visit a website with what goals and the persona a person holds in their online presence.
- Examining questions such as how and why people contribute user-generated content and how to design systems that better enable them to do so.

Some examples include collective intelligence, prediction markets, crowdsourcing markets etc. The multimedia big-data from the popular social websites in the form of videos, images, text, emails, are captured and store into various data repositories from where it can be shared among users. Various steps to be followed in the analysis of big data are represented in Fig. 5. and are described as follows:

● **Data Pre-processing**

Data pre-processing is done for cleaning and transforming the data collected in order to remove noise.

Data cleaning includes

- Noise reduction
- Missing value imputation
- Inconsistencies elimination

Examples of data cleaning include removal of URLs, removal of punctuations including hash-tag '#', removal of repetitive characters, and extra spaces. Further, tokenization is done to obtain a sequence of characters followed by stopping and stemming. Stemming is done to reduce the derived words to their word stem, base or root form. Stop words like the, a, is, she, him, on, etc. are removed as they are used for structuring of sentence and are less influential in identifying sentiment of a sentence. Followed by data cleaning the data is transformed into a structured data format. Data transformation includes

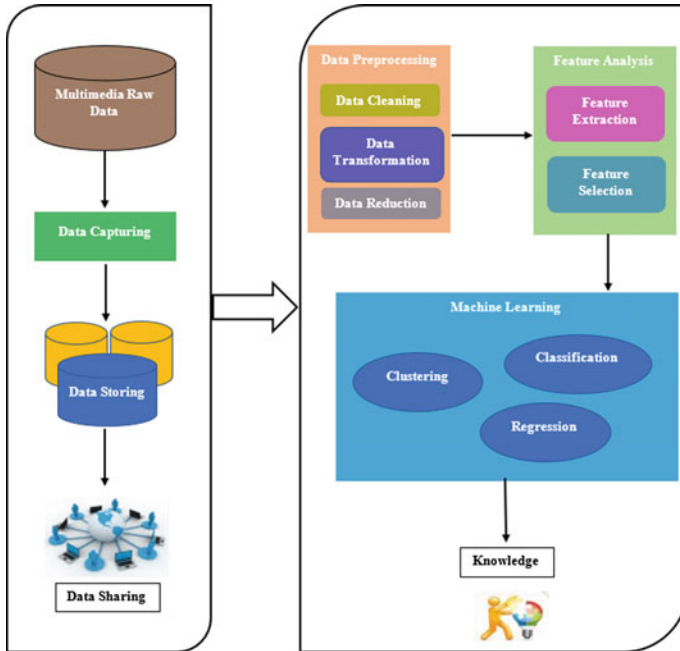

Fig. 5 Steps for analysis of big data

- Data normalization
- Data formatting
- Data aggregation

• **Feature Extraction**

This step identifies the characteristics of the datasets that are specifically useful in order to achieve our aim for example in detecting sentiments. There are different categories of features to be extracted namely, lexical, syntactic and semantic features which come under the category of morphological features. Other than these there are also frequent features and implicit features in the data.

• **Feature Selection**

Feature selection is the process of selecting a subset of features from the original set of features forming patterns in a given dataset [16]. Feature selection is done to reduce the size of problem for learning algorithms which may improve classification accuracy due to reduction in computation requirement as well as increase the speed of the classification task as the size of data to train the classifier is reduced. Feature selection techniques can be classified into two categories: filter approaches and wrapper approaches. The key difference between the two algorithms is that filter algorithms select the feature subset prior to the application of any classification algorithm, i.e. they are classification independent. The filter approach eliminates the

less important features by using statistical properties of features. Wrapper algorithms select the features according to the accuracy of the training data and afterwards learn and test the classification model using the test data. Generally, for the implementation of wrapper methods learning algorithm and the performance criteria are defined.

• **Machine Learning**

Machine learning focuses on the development of computer programs that can access data and use for learning. Machine learning algorithms are broadly classified into Supervised, Unsupervised, and Semi-supervised [17]. Regression and Classification come under Supervised learning (answer for all the feature points are mapped) and Clustering comes under unsupervised learning (answer will not be given for the points).

- Regression—If the prediction value tends to be a continuous value, then it falls under Regression type problem in machine learning.
- Clustering includes grouping a set of points to the given number of clusters.
- Classification—If the prediction value tends to be categorized like yes/no, positive/negative, etc., then it falls under classification type problem in machine learning.

3 SWOT Analysis of Adopting Multimedia Social Big Data Mining in Real-Time Applications

The following Fig. 6 illustrates a typical lifecycle of data.

SWOT analysis can be defined as a model or technique which is used to figure out the strengths, weaknesses, opportunities and threats to a particular person, project or product. It lays the foundation stone for a project as it shows all the positives and negatives in advance and therefore, plays a crucial role in decision making. As the name implies, SWOT analysis for an entity deals with four factors:

- **Strengths:** The traits of the entity which provide it an edge over others.
- **Weaknesses:** The traits of the entity which are most likely to prove as a dis-benefit to itself.
- **Opportunities:** The external elements that the entity can use in order to get maximum benefits.
- **Threats:** The external elements that can prove to be hazardous for the entity in the future.

Considering the importance of SWOT analysis, a SWOT Analysis is carried out to get to know the feasibility and scope of social multimedia content and big data mining [18]. The following sub-sections discuss the details:

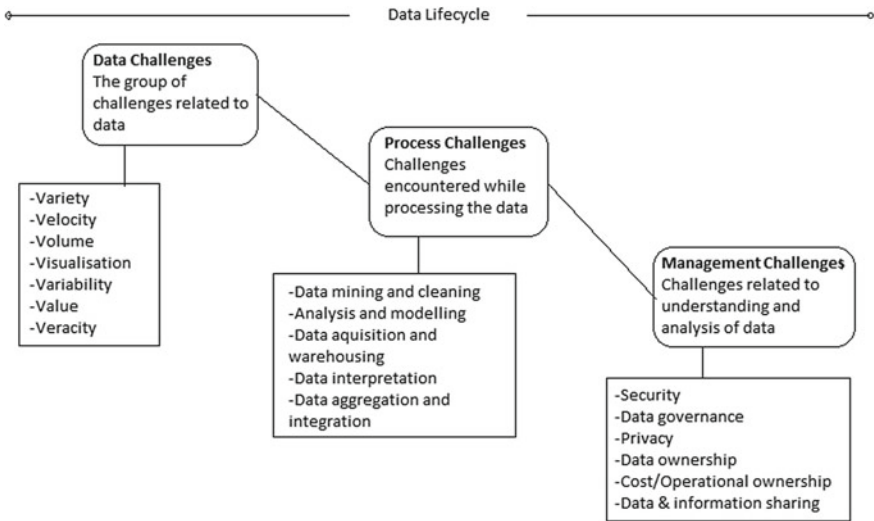

Fig. 6 Data lifecycle

3.1 Strengths

- **Enhance the performance of the business**

The major strength of multimedia social big data mining is that it upgrades the performance of businesses. This is due to the intelligent business systems that it provides. Every business can be analyzed with the use of big data to get to know what is working in its favor and what is working otherwise. The results can be used for modifying existing strategies for maximizing the profit.

- **Targeted users/customers**

Social multimedia content and big data mining provide the targeted customers to a business which will lead to more profit. This is done on the basis of past interests shown by a customer and other features of an individual’s profile which may imply her/his liking for a particular product. This in turn benefits both, the business and the customer.

Also, in social networks like Twitter, Facebook, Quora, it is used to recommend news, users or stories to people based on their past choices and other factors derived from big data mining.

- **Speedy and precise analysis**

By using various machine learning techniques, the analysis of the Social multimedia content and big data has now become very fast. Moreover, if the most suitable technique is used for analyzing a particular problem, then the accuracy of the analysis is also laudable.

- **Improved Strategic decisions**

It is a well-known fact that one takes better decision when she/he is well aware of all the aspects of a situation. In this case also the social multimedia content and big data mining provides a deep insight in the situation which leads to outstanding decision making.

- **Customer/User satisfaction**

Due to targeted campaigning and better understanding of customer preferences provided by the big data, customer gets the required services easily without much effort. Also, in social networks, users get a better experience due to personalized content.

3.2 Weaknesses

- **Risk of wrong conclusions**

While analyzing social multimedia content and big data there are many factors that have to be kept in mind for an efficient and precise analysis, such as the expertise of team in the field they are dealing with. For example, if a team is analyzing a trend in the symptoms of a disease, then all members should have a basic understanding of medical science otherwise it may end up in very wrong predictions. Wrong conclusions are also derived when the data set is not of good quality.

- **Lack of professionals**

There is a need of small enterprises or people who are well efficient in carrying out the analysis of big data. The expertise in this field is a must. Therefore, the focus should be on training more and more individuals in this field so that we achieve the desired level of expertise.

- **Customer privacy at stake**

All the data we are talking about is customer specific. For analysis, one needs a well-defined and detailed data set which comes from the details of customers. This is one of the major weaknesses of social multimedia content and big data analysis.

- **Reduced data set may lead to incorrect analysis**

For making machine learning techniques more effective, we stress on reducing the size of data set, but sometimes this reduction might lead to an incorrect analysis as we may lose some important and deciding features.

3.3 Opportunities

- **Efficient tool for detecting rumor, bully, fake news etc.**

This is one of the most important opportunities in the field of analyzing social multimedia content and big data as it helps in making our environment safer. By using the machine learning techniques efficiently, we can come up with a solution to all these problems.

- **Education and health sector**

This is also a very important opportunity in this field as it touches millions of lives. By analyzing the data related to education sector, we can come to know about the performance of teachers. Also, whether the government education scheme is doing well or not. This will not only lead to better performance of students but also will increase the literacy rate. Similarly, in health sector social multimedia content and big data analysis can prove to be a game changer. Better, low cost and efficient treatment can be provided to everyone.

- **Fraud detection**

Fraud is a major problem every country is facing today. This is present in every sphere of life. Social multimedia content and big data analysis, if done properly, can lead to an efficient fraud detection system.

3.4 Threats

- **Privacy**

With this amount of access of an individual's data social multimedia content and big data analysis has to be very careful. As it may be opposed by people in the future.

- **Identity theft**

There is a very high chance of misuse of social multimedia content and big data mining. One of the main threats is about identity theft as with so much data available about an individual, one can easily access and misuse it for fraudulent practices.

- **Costs**

The costs involved in all these practices may rise up to a level where the cost-benefit ratio goes very low.

- **Social approval**

Social multimedia content and big data analysis may face a challenge in terms of social acceptance. This is due to the fact that it works in the public domain, uses people's information and recommends the results to them, i.e. totally public dependent. Therefore, social acceptance is a must which can be very difficult to achieve when people's privacy is at stake. The following Table 3 summarizes the SWOT Matrix.

Table 3 SWOT matrix

<p>Strengths</p> <ul style="list-style-type: none"> • Enhance the performance of the business • Targeted users/customers • Speedy and precise analysis • Speedy and precise analysis • Improved strategic decisions • Customer/User Satisfaction 	<p>Weaknesses</p> <ul style="list-style-type: none"> • Risk of wrong conclusions • Customer privacy at stake • Lack of professionals • Reduced data set may lead to incorrect analysis
<p>Opportunities</p> <ul style="list-style-type: none"> • Efficient tool for detecting rumour, bully, fake news etc. • Education and health sector • Fraud detection 	<p>Threats</p> <ul style="list-style-type: none"> • Privacy • Identity theft • Costs • Social approval

4 Techniques for Social Big Data Analytics

In this section various techniques which deal with social big data analytics are discussed. Data can be in any form such that text, audio, image or video. Different techniques are used for analyzing different types of data. Generally same methods are translated for different forms of data. The target of social big data analysis is to get to know people's behavior so that personalized content can be created for every individual. Therefore, the techniques are developed to get a deeper insight into how data is flowing or how is this data related to user's preference or what are the trending issues or whether a story is fake, rumour, bully, sarcasm, irony or genuine. The data under observation can be of any kind. Therefore, we need to have different kinds of techniques for different kinds of data. Broadly, this heterogeneity of data can be classified in four forms: Textual data, Audio data, Image data, Video data. Sometimes, when the data has more than one type in it, then we merge the techniques mentioned in this section for better analysis. Various techniques for different kinds of data are discussed in this section.

4.1 Text Analytics

In most of the cases we deal with textual data. This is because of the reason that mostly humans express their views either by speaking or writing. So, this is the basic type of data. Techniques used here are then translated into different forms so as to support other kinds of data. Text analysis mainly deals with the extraction of meaningful and structured data out of unstructured data. The main focus of text analytics is to extract the required information from textual data such as comments, stories, news, tweets, blogs, survey results, logs etc. The accurate analysis of textual data leads to a perfect decision making. Text analytics techniques are discussed below:

Information Extraction

This technique deals with the structuring of a huge unstructured data [19]. For example, one gets to understand the relationships between various entities are using this method. There are two methods which tell the correctness of an information extraction algorithm:

- Precision
- Recall

One of the major tasks of information extraction is to classify the data into entities, i.e. recognizing the class/entity to which a particular entry belongs. The techniques which are used for this classification of data entries into entities and then establishing relationships between these entities based on data are:

- Supervised machine learning techniques
- Semi-supervised machine learning techniques
- Unsupervised machine learning techniques

Supervised machine learning techniques includes Support Vector Machine (SVM), Hidden Markov models, decision tree, naive Bayes, k-nearest neighbor algorithm. Examples of semi-supervised machine learning techniques are bootstrapping, snowball, etc. Clustering algorithms are the examples of unsupervised machine learning techniques.

4.2 Audio Analytics

As the name suggests, audio analytics means analyzing the data which is in audio form to derive the required information from these audio signals. There are many applications of audio analytics. For example, in health care: Proper analysis of an infant's voice can tell his/her health status. Another example is in call centers, where audio/speech analysis is done to improve the quality of their service. The main techniques used for audio analysis are listed below [20].

- Approach based on phonetics

In this technique phonetics is used to classify the input audio. First, the system converts the input audio into a sequence of phonemes. Then the system searches for the output based on the labeling of phonemes.

- LVCSR

LVCSR stands for Large Vocabulary Continuous Speech Recognition. In this approach first step is to match sound to words using various algorithms like ASR (Automatic Speech recognition). The system matches the closest option if it fails to find a perfect match. On the basis of the output an indexed file is maintained, which provides the sequence in which words were spoken in the audio input. In the second step the required information is extracted from the indexed file obtained in step 1.

4.3 *Image Analytics*

Image analytics deals with the extraction of meaningful information from a data set composed of images. This is done using various image processing techniques. The major applications of image analytics are facial recognition, movement analysis. Nowadays, most of the unstructured data available is in image or video form. So, it becomes very important to come up with effective techniques for image analysis. For image analytics the methods or techniques used are basically the translated versions of basic machine learning techniques such as recurrent neural networks, convolution neural networks, deep learning algorithms etc. There is still a huge scope of research in this field. With increase in internet services and devices, more and more people and applications are contributing to data nowadays. To cope up with this speed, we need efficient techniques and infrastructure for better and accurate analysis of data in the form of an image.

4.4 *Video Analytics*

Video analytics is the most challenging one among all. It is mainly due to its size. We can get an idea of this problem with the fact that two second of an HD video is equivalent to 4000 pages of text, in terms of size. So much of data which is very large in size, due to its nature, is being generated in video form [21]. For example, CCTV footages, a camera in everyone's hand, videos uploaded to YouTube and other sites, etc. For analysis the basic machine learning techniques are modified for video analysis. These techniques also deal with the reduction in frame rate, resolution of images for easier analysis, but this reduction may lead to a less accurate prediction. Here also, there is a huge scope of improvement in techniques. A better database management system is also the need of the hour for analyzing data in the form of video. This will also reduce the training time.

5 Applications of Multimedia Social Big Data Mining

5.1 *Trust and Information Veracity Analysis of Social Media Data*

The web and social media have become an integral part of the daily lives of the general mass of people for the past decade. Social network platforms like Facebook and microblogging sites like Twitter have become ubiquitous. Given how readily accessible these platforms are they have become an indispensable source of information

during real-time events be it a natural disaster, terrorist attacks, political campaigns, epidemics or any other breaking news. Social media users are far ahead in posting up-to-date information than any news channels or news websites. As a result, many people rely on these platforms for getting real-time information in times of crisis and otherwise. Given the humungous data generated by social media users, it is challenging and at the same time imperative to analyze the trustworthiness and the veracity of the information. Although, a rich and accessible source of information, it is not a reliable one. On one hand the accessibility allows greater dissemination of important information, but on the other hand it also allows the spread of unauthentic information.

Indeed, trust and veracity are one of the major caveats of social media posts. To add to it, sometimes this happens that the user is posting some information and doesn't know that what he is posting is wrong. The restlessness of people to post latest information which in turn leads to greater likes, shares, comments and shares on their updates overpowers their ability to pause, think and research if what they are posting is even true or not or even if their information is coming from a credible source. Credible sources, on the other hand, like news websites, news channels' websites, blogs of reporters and journalists are themselves not completely trustworthy, to say nothing of others. They are always on verge of competition and trying to be the first one to bring the latest updates that they do not verify the veracity status of their information. Fake news generation is also a major issue with news websites. Although, some fake news are honest mistakes, but usually it is too late by the time the mistake is realized, the harm has already been done. Public figures like politicians, celebrities suffer the most due to these fake news and untrustworthy information sometimes forcing them to take extreme measures. Disasters are another crucial time when the credibility of information is most crucial. Although there are many people who genuinely want to help and post true or eye witness updates, there are many who simply pass on the information but proper verification. Although, they might not personally aim to cause mischief, but most people get trapped by the rumor mongers. For instance, during an earthquake in Chile rumors spread through Twitter that a volcano became active and there was a tsunami warning in Valparaiso [22]. Later, these reports were found to be false.

Thus, if not monitored, social media can be a breeding ground of rumors. Rumors not only give out false information (which may be intended or unintended) but can jeopardize the lives of people in some situations, tarnish the images of public figures in some and cause general unrest among the masses in others. This has been a great concern lately and many researchers have probed into the area of rumor detection and veracity.

Kumar and Sangwan [23] define rumor as, "any piece of information put out in public without sufficient knowledge and/or evidence to support it thus putting a question on its authenticity. It may be true, false or unspecified and is generated intentionally (attention seeking, self-ambitions, finger-pointing someone, prank, to spread fear and hatred) or unintentionally (error). Further, these can be personal as well as professional." They further provide the classification of information into rumor and non-rumor as shown in Fig. 7.

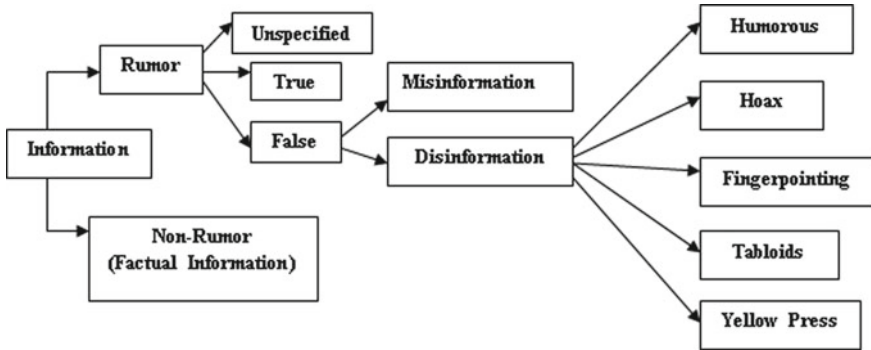

Fig. 7 Classification of rumors [23]

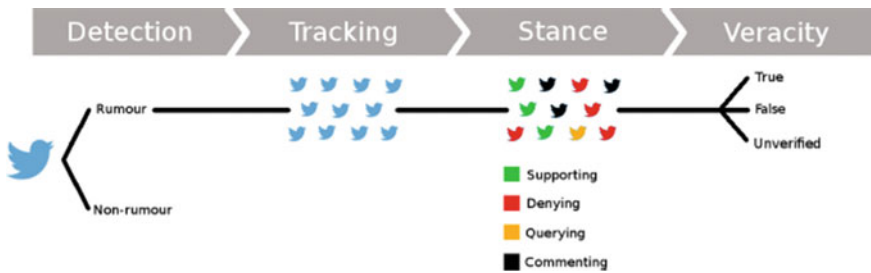

Fig. 8 Architecture of a rumor classification system [26]

There have been other attempts in classifying rumors such as based on veracity [24], credibility [25] and temporal characteristics [26].

Majority of the rumor detection work has been done on Twitter and Sina Weibo, a Chinese micro blogging platform with features similar to Twitter. Facebook, although one of the most popular social media on the web has not been explored much by researchers due to its restriction for data collection. Twitter provides its API for extracting data easily and free of cost, hence it is a viable choice for researchers. The data collections also depend largely on the type of rumors that one is gathering data for. It is easier for long standing rumors as one can search well defined hashtags and keywords for the rumors. Data collected from these rumors is useful for monitoring shift in the public opinion regarding the issue over a large span of time [26]. When it comes to gathering data for emerging rumors, it becomes more challenging due to the absence of well-defined keywords and hashtags. The rumor detection system can be used to detect these emerging rumors (Fig. 8).

Zubaiga et al. [26] propose the following components of a typical rumor classification system:

- a. *Rumor Detection*: Given a stream of text/tweets as input this component can act as a binary classifier for detecting emerging rumors. PHEME and RumorEval are the two most popular publicly available annotated data sets for rumors.

- b. *Rumor Tracking*: Given the identified rumors, this component keeps track of the posts discussing the rumor and keeping only those which are relevant and discarding the irrelevant ones. This component of the rumor detection system comes into play after a rumor has been detected and the subsequent posts regarding the rumor are tracked. The posts can either be filtered using relevant keywords that are monitored thus restricting the scope of the rumor tracking system or it can be input a stream of posts that are not limited by the filtering keywords thus broadening the scope. The output of the rumor tracking component would be posts labeled as being ‘related’ or ‘unrelated’ to the rumor being tracked. The dataset of 10,000 tweets developed by is the most widely used for rumor tracking.
- c. *Stance Classification*: Given the posts discussing a rumor as tracked by the previous component, stance classifier can act as a multi class classifier labeling each post into classes such as denying, supporting or questioning the rumor. Thus, it can be used to determine the orientation of each post in response to a source tweet. However, it can be omitted where the stance of the public is not considered useful, e.g., cases solely relying on input from experts or validation from authoritative sources. PHEME is a widely used dataset that is publicly available for stance classification and gives annotations for stance of each tweet as support, deny, query, comment.
- d. *Veracity Classification*: This final component uses the labeled posts from the stance classifier and additionally data from other sources like news websites and, or other databases to determine a truth value for the rumor. The rumor can be verified to be true, debunked as being false or labeled as being unresolved yet. The performance of this component can be measured using measures such as accuracy, precision and recall. The RumorEval 2017 dataset under the SemEval2017 task consist of 300 rumors with veracity labeled as being true, false or unverified.

The first work that focused on detecting emerging rumours was done by Zhao et al. [27]. They assume that the rumors will invoke questioning tweets inquiring about their veracity. This can be used to detect the tweets as being rumors. They have used SVM, and decision trees for their approach. Zubiaga et al. [28], on the other hand, proposed an approach that is able to learn context during a breaking news story and can determine whether a tweet is rumorous or not. They used the hypothesis that a single tweet might not be sufficient for knowing if its underlying story is a rumour, as there is insufficient context. They used Conditional Random Fields (CRF) as a sequential classifier that was able to learn the dynamics of reporting during an event, such that the classifier can decide, for every incoming tweet, if it is a rumor on the basis of what has been seen by the system up to that point regarding the event. Their method improved the result in comparison to the baseline classifier by Zhao et al. [27]. The classifier achieved 0.667 in precision and 0.556 in the recall, compared to 0.410 and 0.065 respectively for the classifier by Zhao et al. [27].

Rumor tracking has been explored little with the early work by Qazvinian et al. [29] being the only prominent one. They performed automated rumor tracking on a collection 10,000 tweets and used supervised machine leaning on various categories of features like content, network and Twitter specific. They have also studied stance

classification in their work. However, the most pioneering work in stance classification has been done by Mendoza et al. [30] from which they found that Twitter users largely support true rumors. Their study indicates that stances to rumor tweets can be helpful in predicting veracity. Veracity classification has been one of the most studied aspects of rumors. The research for this task was initiated by Castillo et al. [31] who studied credibility perceptions of rumors and is considered a baseline for many subsequent works regarding veracity. Kwon et al. [32] suggested a novel feature types: temporal, structural and linguistic and used random forest, SVM and logistic regression and perform feature selection with the latter giving the best results. In [33] they have analyzed feature stability and found that structural and temporal features identify rumors over a long-term window. However, these are available only at later stages of rumor spread.

Little work has been on rumor tracking and origin detection. These areas can be explored extensively. Also, a finer grain classification of rumors into misinformation, hoaxes etc. as classified by Kumar and Sangwan can be explored.

5.2 *Sentiment Analysis and Opinion Mining for Social Well-Being*

Sentiment Analysis and Opinion Mining is “the field of study that examines people’s opinions, sentiments, evaluations, attitudes, and emotions from written language” [34]. Due to the abundant volume of opinion rich Web data, for example, micro blogging, news and website reviews, etc. accessible online via Internet, a significant part of the recent research is concentrating on the ongoing area of text mining (TM) field which is called as Sentiment Analysis (SA).

The term “opinion mining” was first observed in 2003 in a research paper by Dave et al. by 2006 [35] and thereafter, it spread to include Web applications and various other social wellbeing domains like marketing for product and service reviews, entertainment, politics, business, recommendations etc. which in turn broaden its application spectra. With the rapid rise of peoples’ participation and communication over social web where they express their ideas, opinions or sentiments over a public forum; SA extracts the public mindset and the findings are being used in various domains [36]. Next section briefs about the “What, Why and How Factors-WWH” of SA for Social well-being.

5.2.1 **Sentiment Analysis: What?**

SA is computational identification and classification of sentiments which are being expressed as written text on any particular topic, blogs, product reviews etc. [37] and has emerged as a dynamic area of research. Individuals are expected to build up a system that can identify, distinguish, arrange and classify sentiments accurately.

Fig. 9 Structure of a sentiment

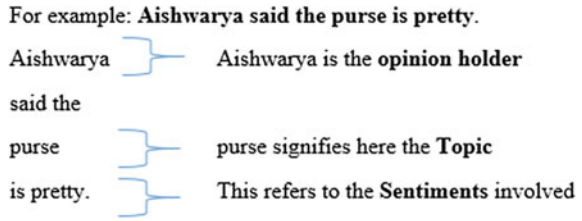

The system should derive the mood and polarity of the sentiments [38]. SA analyzed the vast amount of heterogeneous information generated by social media users every day.

The ideology of SA is to search for opinions, identify the sentiments involved in it and classifying it based on its polarity as illustrated in Fig. 9.

5.2.2 Sentiment Analysis: Why?

SA is an emerging area of research in Natural Language Processing (NLP) and is widely studied in the fields of data, text and web mining. SA is not only limited to the field of computer science, but it also has applications in management and social sciences. The growing significance of SA accords with the development of social media (SM) such as reviews, forum discussions, blogs, micro-blogs, Twitter, and social networks etc. [39]. This is the first time when a large volume of digitized opinionated data is available to us ready to be analyzed. Today, people express opinions largely through social media thus increasing the reliance on social networking sites Facebook, Twitter, etc. for decision making which extensively marks the increasing significance of SA in our daily lives [40].

For example, if an individual need to visit a place, instead of asking his friends, relatives or agents, etc., he simply turns on to its online real-time reviews of the visitors before taking any decision. Also, in terms of business management, if a client needs to buy a product, he first reads all its reviews and then eventually reaches to a decision whether to buy or not buy that product. Hence, we see that this content is available in huge quantity and is too vast to be analyzed meticulously, effectively and efficiently. Here comes the role of SA, which classifies the opinions based on its polarities.

5.2.3 Sentiment Analysis: How?

Sentiment analysis (SA) systems are being applied for practically all the social well-beings i.e. to almost all the business and social domain as opinions are central to most human activities and are considered to be the key influencers of our behaviors

as well. Our beliefs and perceptions of reality, and therefore the selections we tend to make are basically conditioned on however others see and assess the world. For this reason, when we need to make a decision we regularly hunt down the opinions of others. This can be true not just for people, however conjointly for organizations as well. Various Web 2.0 tools and technologies can be used for efficiently evaluating the user opinions in real time [41].

5.2.4 Applications of Sentiment Analysis for Social Well-Being

With the rapid growth of SM, SA has become one of the most upcoming research areas in NLP. Its application is also widespread, ranging from business services, health cares, commercialization and industrialization to political campaigns [42–48] etc. It also involves various types of social well-being such as:

- *Tracking collective user opinions for rating of the products and services (E-commerce and Product analytics)*
- *Analyzing consumer trends, competitors and market buzz (E-industry)*
- *Measuring response to company-related events and incidents (SM Monitoring)*
- *Monitoring critical issues to prevent negative viral effects (Market Research and Analysis)*
- *Customer Support (Voice of Customer)*
- *Evaluating feedback in multiple languages*
- *Brand Monitoring*

Thereafter, it is quite evident to say that sentiment analysis in the business can prove a major breakthrough for the complete brand revitalization. The key to running a successful business with sentiment data is the ability to exploit the unstructured data [49–53] for following actionable insights.

1. Business intelligence build up

Having insight and knowledge about the information at hand, eradicates the guess work enables to take and execute decisions in a timely fashion. Given the data today abundant with the sentiments about the established and the new products, estimating the customer retention rate has become much easier. Moreover, the reviews formed by sentiment analysis can prove helpful in adjusting the business strategy in accordance with the current market situation and hence lead to greater customer satisfaction. Keeping up and maintaining dynamicity is imperative in business intelligence and with the opinioned data at hand, one gets liberty.

2. Competitive advantage

Knowledge of the sentiments regarding the data of one's business competitors facilitates us to better our performance learning from their strengths and limitations. Sentiment Analysis and opinion mining can be also proved to be very helpful in foreseeing customer trends and forming business and marketing strategies accordingly.

3. Enhancing the customer experience

Customer satisfaction is the fertile ground on which any business flourishes. The satisfaction level of customers can be analyzed using sentiment analysis regarding various aspects of the business. This lets us know what has been well received in relation to products, services and customer support and what needs to be improved.

4. Brand branding

The transition a business from being a startup to being a well-known and reputed brand depends on how well is the online marketing, social campaigning and content marketing done as well as how good is the customer support service. Sentiment analysis can help a business to know how its marketing strategies are being received, what needs to change and what needs to be improved.

The applications of sentiment analysis in E-commerce, product analysis, E-industry, market research and analysis [54–60] are overwhelming. It is also very useful in checking social media as it lets us get an indication of the broader public view on various topics. The applications of which are broad and powerful.

Few of the examples are as follows:

- The Obama administration used sentiment analysis to gauge public opinion to policy announcements and campaign messages ahead of 2012 presidential elections. Being able to quickly see the sentiment behind everything from forum posts to news articles means being better able to strategize and plan for future [61].
- Expedia Canada took advantage of this technique when they noticed there was a steady increase in negative feedback to the music used in one of their television advertisements [62]. Sentiment analysis conducted by the brand revealed that the music played on the commercial had become irritating after multiple airings. Rather than chalking it up as a failure, Expedia was able to address the negative sentiments in a playful and self-knowing way by airing a new version of the advertisement which featured the offending violin being smashed.

These days, sentiment analysis is used to address social problems as well, such as:

- Fighting infectious diseases

Understanding and influencing the confidence level and trust of the general public during an outbreak can help public health officials slow the spread of the disease.

- Preparing people for the future of work

How positive or negative a population feeling about the threat of automation is an indication of how well prepared they are for the upcoming changes.

- Promoting social inclusion

Efforts around the world to combat the spread of anti-immigrant, racist or anti-LGBTQ sentiment among young people increasingly rely on effective monitoring of the social media.

- Saving the environment

Whether raising public awareness about the impact of climate change or the pollution of the world's ocean, influencing public perceptions of environmental destruction is critical to changing course.

These applications of sentiment analysis have a very positive impact on the society and the environment, thus proving its huge relevance for social well-being.

5.3 Detection of Illicit Behavior and Bullying in Social Media

Web 2.0 is extending and evolving in terms of the volume, velocity and variety of information accessible online across various social media portals which affirms that the social media (SM) has global reach and has become widespread [63]. There are various benefits of SM but few people use it in the wrong way. One such illicit use of SM is to bully someone is known as Cyberbullying (CB). The term 'Cyberbullying' was coined by anti-bullying activist Bill Belsey in the year 2003 [64]. Tokunaga defined CB as "*any behavior performed through electronic or digital media by individuals or groups that repeatedly communicates hostile or aggressive messages intended to inflict harm or discomfort on others*" [65]. Different characteristics are highlighted by this definition like, the technology part, the antagonistic behavior of the act, reason to cause suffering, considered by most scholars to be crucial to the definition, and repetitiveness [63]. Cyberbullying or illicit behavior over social networks has already been designated as a major threat to public health by CDC (Centers for Disease Control and Prevention) [63]. CB can be possible through any of the media like mobile phones or using internet. CB may be done through emails, instant messages, chat rooms, blogs, images, video clip, text messages etc. [66, 67].

CB can be classified into direct CB and indirect CB. Direct CB is to harass or humiliate a person directly either through email, SMS etc. Indirect CB is done by posting harmful or humiliating content related to someone on SM. There are various types of CB explained in Table 4.

Table 4 Types of Cyberbullying

Types of CB	Description
Flaming	Online fight between people posting messages that contain offensive language [68]
Harassment	Posting messages in order to insult or threaten the victim [68]
Denigration	Spreading rumors in order to harm the reputation of the victim [68]
Impersonation	Impersonate the victim and using this fake identity in damaging ways [68]
Outing and trickery	Acquiring the trust of the victim and the violating it by disclosing secrets of the victim [68]
Exclusion	Excluding the victim from groups or other online activities [68]

5.3.1 Incidences and Effects of Cyberbullying

Cyberbullying can happen at any age, sex and at any geographical location via any SM like Twitter, Facebook, social forums. It can be related to personal, racial, religious or cultural. The first reported case of CB was the case of Ryan Halligan of Vermont in 2003 [69]. Ryan was an American student who was constantly being bullied in person and via online by his classmates, that eventually forced him to commit suicide at the age of 13 only. But no legal actions could be taken against the culprits due to non-availability of proper laws pertaining to CB at that time. According to a survey, two third of the students in grade 7–9 belonging to middle class family or diverse communities in Calgary suffered from CB [70]. Another study [71] on a similar pattern exhibited that 15% of the students of 7th grade bullied others. Amongst all, fewer than 35% of the incidents were reported to the adults. Numerous studies showed that in school CB may occur due to lower academic performances, lower level of attachment and commitment to school or lower positivity in the school climate [71]. Age and demographic features also add to it. All this eventually affects the mind and body of the child and may lead to some of the disastrous effects such as committing suicides. CB may also occur due to the feelings of low self-confidence, suicidal ideation, annoyance, frustration, and various other emotional and psychological problems [72].

Research shows that persons who are facing CB are the ones who are victims of traditional bullying as well, but what makes CB more pervasive in the victim's life is the fact that CB can be reached at any given time of the day while in the traditional bullying, the bullying behavior usually happens during school time and stops once victims return home [64]. Therefore, the persistence of the cyber bullying behaviors may result in even stronger negative outcomes than traditional bullying [65, 73]. Moreover, CB has all those risk factors that are there in traditional bullying.

In addition, it has other aspects also that are very dangerous and can't be ignored like sometimes because of ignorance about the drawbacks and risks of sharing personal information over the Internet or sharing passwords on the internet, communicating with unknown people, a very little control exerted over personal information, which may lead towards CB [74]. Therefore, rather than being physically strong, CB tend to be more technologically savvy and should be able to catch the loopholes and remove them. It should work in a way so as to hide the electronic trails of victims, and use bullying “repertoire,” which now includes identity theft, account hacking, infecting a victim’s computer, impersonation, or posting embarrassing content [63].

In the year 2015, it was shown in a report in Italy that the users of 11–17 ages are bullied through email, SMS, or social networks. In the year 2016, there were 230 cases of cyberbullying that had been reported [75]. Recently, the Anti-cyberbullying Law, Law No. 71/17, officially came into force after getting approved by the parliament of Italy, which targets to tackle online bullying of children after several high-profile cases in which victims have committed suicide [76].

5.3.2 Cyberbullying Detection

Cyberbullying leaves an impression on the minds of cyber-victim. Thus, it is the need of the hour to detect CB. The process of CB detection is divided into different phases. It involves pre-processing of data, feature extraction, feature selection and classification of messages in bullying and non-bullying as shown in Fig. 10.

The first phase involves pre-processing of data, such as cleaning of data, correcting words, handling missing values, etc. Features are extracted from the pre-processed data, such as n-grams, skip-grams, profane words etc. Features are selected from

Fig. 10 Generic CB classification process

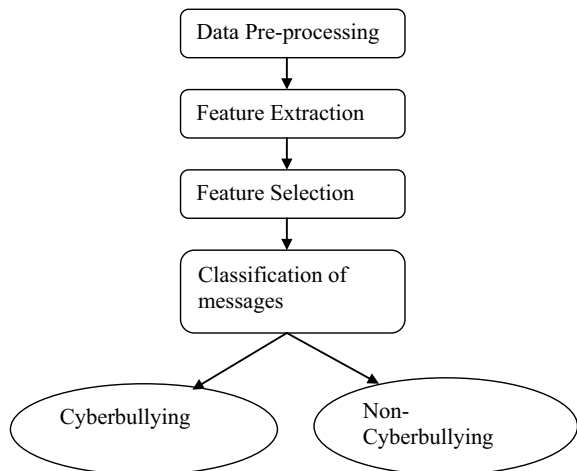

extracted features which are best and most effective. Finally, classification of messages is done to classify messages into bullying and non-bullying.

There are few software available to deal with cyberbullying e.g., [77–79]. Though, filters generally work with a basic key word search and sentiments of the text cannot be understood by the filters. There are some filters that block such webpage which contains some offensive keyword, while there are some such filters that just shows a blank webpage if any bullying keyword is detected. However, there are various techniques by which the filters can be dodged very easily, and thus it is true that filters are not that efficient and effective method for cyberbullying detection. Using chat rooms, mobile communication and peer-to-peer networking the blocked content can bypass central servers that maintain the filters. Another limitation is that the filtering methods have to be set up and maintained manually.

Various cyber bullying detection techniques has been applied by the researchers in the past few years in order to classify the bully comments more accurately and to make such models that will work quietly efficiently for the required task.

The Table below shows a few examples of the recent work done by various researchers for detection of cyber bullying. The Table 5 contains columns that show, which dataset used by the researchers to work on, what type of techniques and tools that have used, which type of social media site they have referred and also what results they have got.

There are several deep learning methods also that nowadays are being used in order to detect this illicit behavior over social networking sites. Deep learning methods, like CNN, RNN, are more efficient and has been proved more accurate by the researchers.

6 Conclusion

The chapter presents various aspects of Big Data including its characteristics, types, applications, etc. with the special attention on multimedia social big data which constitutes of data generated on social media sites and that is progressively growing. The data generated online not only consist of text, but images, videos, sensor information, emails, etc., which makes it complex in nature and difficult to store. There are some tools specifically used for storage and analysis of big data. Generation of big data cannot be stopped, but if utilized properly, it can be used in various research domains. Researchers are working on many applications of big data which includes rumor detection, sentiment analysis, sarcasm detection, cyber bullying detection, which have been explained in the chapter. As the data increases, it puts pressure on internet, web, applications, technology, etc. and demands advanced technology tools and software for processing of big data which could be challenging in the future. Some other applications of big data include fraud detection (credit card fraud, online auction fraud, insurance fraud, etc.), analysis of sales trends based on customer's buying history, applications in healthcare (personalized medicine and prescriptive analytics, effective treatment, drug side effects), applications in manufacturing (product

Table 5 State-of-art of cyber bullying

S.no.	Author	Year	Techniques	Social media	Data set	Tools	Results
1	Agrawal and Awekar	2018	Deep neural network	Twitter	Posts from Formspring, Twitter, Wikipedia	CNN, LSTM, BLSTM, and BLSTM with attention	DNN based models coupled with transfer learning beat the best-known results for all three datasets
2	Chen et al.	2018	CNN, Word2vec, Glove	Twitter	Comments from Twitter	Wordnet, porter	The proposed CNN model with 2-dimensional TF-IDF matrix results in improvement (with accuracy equals to 0.92 and Macro-AUC equals to 0.98) compared with the baseline SVM and logistic regression methods
3	Andriansyah et al.	2010	SVM	Instagram	Comments on Instagram accounts of some Indonesian celebrities	R language, R Studio ide	The SVM model is able to classify the test set with an accuracy of 79.412%
4	Ting et al.	2017	Social network analysis, data mining	Facebook, Twitter, Ptt and CK101	100 posts from each website like Facebook, Twitter, ptt and ck101	-	The precision accuracy is around 0.79 and the recall is 0.71
5	Lorenz and Kikkas	2013			Data was collected by means of closed questions or Likert scale options. (study was performed twice 2009, 2012)		There were only 1–3 phones in every class that were useful as a learning device

(continued)

Table 5 (continued)

S.no.	Author	Year	Techniques	Social media	Data set	Tools	Results
6	Badri et al.	2016	T-tests, chi square		More than 31,000 children from private and public schools participated in the online survey. More than 31,000 children from private and public schools participated in the online survey.		A high home access to the Internet of 91.7%. There is a negative correlation between time spent on social networks and perceived student performance in specific subjects
7	Bin et al.	2018	Random forest classifier	Reddit	Kaggle, It consisted of 6,594 raw comments	Skip-gram model architecture, Gensim (python library), natural language tool-kit	This model outperforms both the pre-trained word vectors, as well as the handcrafted methods by 3% more in AUC and 12% more on precision
8	Alduailej and Khan	2017	Text mining, lexical approach	Twitter	Arabic tweet conversation from Twitter	RapidMiner, Python	Using text mining techniques cyberbullying can be detected automatically. The creation of lexicon of offensive Arabic words is the second approach that is presented in the paper

quality, supply planning, defects tracking), cybersecurity and intelligence, weather forecasting, traffic optimization, and many more.

References

1. J. Oliverio, A survey of social media, big data, data mining, and analytics. *J. Ind. Integr. Manag.* 1850003 (2018)
2. D. Borth, T. Chen, R. Ji, S.-F. Chang, SentiBank: large-scale ontology and classifiers for detecting sentiment and emotions in visual content, in *Proceedings of the 21st ACM international conference on Multimedia, 21–25 October 2013* (Barcelona, Spain, 2013), <https://doi.org/10.1145/2502081.2502268>
3. A. Krizhevsky, I. Sutskever, G.E. Hinton, ImageNet classification with deep convolutional neural networks, in *Proceedings of the 25th International Conference on Neural Information Processing Systems, 03–06 December, 2012* (Lake Tahoe, Nevada, 2012), pp. 1097–1105
4. J. Weston, S. Bengio, N. Usunier, Wsabie: scaling up to large vocabulary image annotation, in *Proceedings of the Twenty-Second International Joint Conference on Artificial Intelligence, 16–22 July 2011* (Barcelona, Catalonia, Spain, 2011), pp. 2764–2770, <https://doi.org/10.5591/978-1-57735-516-8/ijcai11-460>
5. M. Wang, D. Cao, L. Li, S. Li, R. Ji, Microblog sentiment analysis based on cross-media bag-of-words model, in *Proceedings of International Conference on Internet Multimedia Computing and Service, 10–12 July 2014* (Xiamen, China, 2014), <https://doi.org/10.1145/2632856.2632912>
6. A.B. Alencar, M.C.F. de Oliveira, F.V. Paulovich, Seeing beyond reading: a survey on visual text analytics. *Wiley Interdiscip. Rev. Data Min. Knowl. Discov.* **2**(6), 476–492 (2012)
7. I.E. Fisher, et al., The role of text analytics and information retrieval in the accounting domain. *J. Emerg. Technol. Account.* **7**(1), 1–24 (2010)
8. X. Hu, H. Liu, Text analytics in social media, in *Mining Text Data*, (Springer, Boston, MA, 2012), pp. 385–414
9. C.C. Aggarwal, H. Wang, Text mining in social networks, in *Social Network Data Analytics* (Springer, Boston, MA, 2011), pp. 353–378
10. Tobias Schreck, Daniel Keim, Visual analysis of social media data. *Computer* **46**(5), 68–75 (2013)
11. K. O'Halloran, A. Chua, A. Podlasov, The role of images in social media analytics: a multimodal digital humanities approach, in *Visual Communication* (De Gruyter, 2014), pp. 565–588
12. N. Diakopoulos, M. Naaman, F. Kivran-Swaine, Diamonds in the rough: social media visual analytics for journalistic inquiry. in *2010 IEEE Symposium on Visual Analytics Science and Technology (VAST)* (IEEE, 2010)
13. Bogdan Batrinca, Philip C. Treleaven, Social media analytics: a survey of techniques, tools and platforms. *AI Soc.* **30**(1), 89–116 (2015)
14. Tobias Schreck, Daniel Keim, Visual analysis of social media data. *Computer* **46**(5), 68–75 (2013)
15. W. Mason, J.W. Vaughan, H. Wallach, *Mach. Learn.* **95**, 257 (2014). <https://doi.org/10.1007/s10994-013-5426-8>
16. X. Wang, J. Yang, X. Teng et al., Feature selection based on rough sets and particle swarm optimization. *Pattern Recogn. Lett.* **28**(4), 459–471 (2007)
17. M.I. Jordan, T.M. Mitchell, Machine learning: trends, perspectives, and prospects. *Science* **349**(6245), 255–260 (2015)
18. Mohammad Ahmadi, Parthasarati Dileepan, K. Wheatley Kathleen, A SWOT analysis of big data. *J. Educ. Bus.* **91**, 1–6 (2016). <https://doi.org/10.1080/08832323.2016.1181045>
19. R. Talib, M.K. Hanif, S. Ayesha, F. Fatima, Text mining: techniques, applications and issues. *Int. J. Adv. Comput. Sci. Appl. (IJACSA)* **7**(11) (2016)

20. P. Vashisht, V. Gupta, (2015). Big data analytics techniques: a survey, pp. 264–269. <https://doi.org/10.1109/icgciot.2015.7380470>
21. R. Reka Dr, K. Saraswathi, K. Sujatha Dr, A review on big data analytics. *Asian J. Appl. Sci. Technol. (AJAST)* **1**(1), 233–234 (2017)
22. Carlos Castillo, Marcelo Mendoza, Barbara Poblete, Predicting information credibility in time-sensitive social media. *Internet Res.* **23**(5), 560–588 (2013)
23. A. Kumar, S.R. Sangwan, Rumour detection using machine learning techniques on social media, in *International Conference on Innovative Computing and Communication*. Lecture Notes in Networks and Systems (Springer, 2018)
24. A. Zubiaga, M. Liakata, R. Procter, G.W.S. Hoi, P. Tolmie, Analysing how people orient to and spread rumours in social media by looking at conversational threads. *PLoS One* **11**(3), 1–29 (2016)
25. M.E. Jaeger, S. Anthony, R.L. Rosnow, Who hears what from whom and with what effect a study of rumor. *Personal. Soc. Psychol. Bull.* **6**(3), 473–478 (1980)
26. A. Zubiaga, et al., Detection and resolution of rumours in social media: a survey. *ACM Comput. Surv. (CSUR)* **51**(2), 32 (2018)
27. Z. Zhao, P. Resnick, Q. Mei, Enquiring minds: early detection of rumors in social media from enquiry posts, in *Proceedings of the 24th International Conference on World Wide Web* (International World Wide Web Conferences Steering Committee, 2015)
28. A. Zubiaga, M. Liakata, R. Procter, Learning reporting dynamics during breaking news for rumour detection in social media (2016). [arXiv:1610.07363](https://arxiv.org/abs/1610.07363)
29. V. Qazvinian, et al., Rumor has it: identifying misinformation in microblogs, in *Proceedings of the Conference on Empirical Methods in Natural Language Processing* (Association for Computational Linguistics, 2011)
30. M. Mendoza, B. Poblete, C. Castillo, Twitter under crisis: can we trust what we RT? in *Proceedings of the first workshop on social media analytics* (ACM, 2010)
31. C. Castillo, M. Mendoza, B. Poblete, Information credibility on Twitter, in *Proceedings of the 20th international conference on World wide web* (ACM, 2011)
32. S. Kwon, et al., Prominent features of rumor propagation in online social media, in *2013 IEEE 13th International Conference on Data Mining* (IEEE, 2013)
33. Sejeong Kwon, Meeyoung Cha, Kyomin Jung, Rumor detection over varying time windows. *PLoS One* **12**(1), e0168344 (2017)
34. A. Kumar, T.M. Sebastian, Sentiment analysis on Twitter. *IJCSI Int. J. Comput. Sci.* **9**(4), 372–378 (2012)
35. K. Dave, S. Lawrence, D.M. Pennock, Mining the peanut gallery: opinion extraction and semantic classification of product reviews, in *Proceedings of the 12th international conference on World Wide Web* (ACM, 2003), pp. 519–528
36. A. Kumar, A. Sharma, A. Socio-sentic framework for sustainable agricultural governance. *Sustain. Comput. Inform. Syst.* (2018)
37. B. Pang, L. Lee, Opinion mining and sentiment analysis. *Found. Trends Inf. Retr. J.* **2**(2), 1–135 (2008)
38. A. Kumar, T. Sebastian, Sentiment analysis: A perspective on its past, present and future. *Int. J. Intell. Syst. Appl.* **10**, 1–14 (2012)
39. A. Kumar, A. Jaiswal, Empirical Study of Twitter and tumblr for sentiment analysis using soft computing techniques, in *Proceedings of the World Congress on Engineering and Computer Science*, vol. 1 (2017)
40. B. Liu, *Sentiment Analysis Mining Opinions, Sentiments, and Emotions* (Cambridge University Press, Chicago, 2015)
41. A. Kumar, V. Dabas, A social media complaint workflow automation tool using sentiment intelligence, in *Proceedings of The World Congress on Engineering 2016*. Lecture Notes in Engineering and Computer Science (2016), pp. 176–181
42. A. Kumar, A. Joshi, Ontology Driven Sentiment Analysis on Social Web for Government Intelligence, in *Special Collection on eGovernment Innovation in India* (2017), pp. 134–139

43. E. Cambria, B. Schuller, Y. Xia, C. Havasi, New avenues in opinion mining and sentiment analysis. *IEEE Intell. Syst.* **28**, 15–21 (2013)
44. R. Feldman, Techniques and applications for sentiment analysis. *Commun. ACM* **56**, 82–89 (2013)
45. A. Montoyo, P. Martínez-Barco, A. Balahur, An overview of the current state of the area and envisaged developments. *Decis. Support Syst.* **53**, 675–679 (2012)
46. S. Finn, E. Mustafaraj, Learning to discover political activism in the Twitter verse. *KI-KünstlicheIntelligenz* **27**, 17–24 (2013)
47. A. Trilla, F. Alias, Sentence-based sentiment analysis for expressive text-to-speech. *IEEE Trans. Audio Speech Lang. Process.* **21**, 223–233 (2013)
48. S. Tuarob, C.S. Tucker, M. Salathe, N. Ram, An ensemble heterogeneous classification methodology for discovering health-related knowledge in social media messages. *J. Biomed. Inform.* **49**, 255–268 (2014)
49. J. Brynielsson, F. Johansson, C. Jonsson, A. Westling, Emotion classification of social media posts for estimating people’s reactions to communicated alert messages during crises. *Secur. Inform.* **3**, 1–11 (2014)
50. P. Burnap, M.L. Williams, L. Sloan, O. Rana, W. Housley, A. Edwards, V. Knight, R. Procter, A. Voss, Tweeting the terror: modelling the social media reaction to the Woolwich terrorist attack. *Soc. Netw. Anal. Min.* **4**, 1–14 (2014)
51. A. Makazhanov, D. Rafiei, M. Waqar, Predicting political preference of Twitter users. *Soc. Netw. Anal. Min.* **4**, 1–15 (2014)
52. P. Bogdanov, M. Busch, J. Moehlis, A.K. Singh, B.K. Szymanski, Modeling individual topic-specific behavior and influence backbone networks in social media. *Soc. Netw. Anal. Min.* **4**, 1–16 (2014)
53. X. Fu, Y. Shen, Study of collective user behaviour in Twitter: a fuzzy approach. *Neural Comput. Appl.* **25**, 1603–1614 (2014)
54. X. Chen, M. Vorvoreanu, K. Madhavan, Mining social media data for understanding students’ learning experiences. *IEEE Trans. Learn. Technol.* **7**, 246–259 (2014)
55. P. Burnap, M.L. Williams, Cyber hate speech on Twitter: an application of machine classification and statistical modeling for policy and decision making. *Policy Internet* **7**, 223–242 (2015)
56. A. Zubiaga, D. Spina, R. Martinez, V. Fresno, Real-time classification of Twitter trends. *J. Assoc. Inf. Sci. Technol.* **66**, 462–473 (2015)
57. P. Andriotis, G. Oikonomou, T. Tryfonas, S. Li, Highlighting relationships of a smartphone’s social ecosystem in potentially large investigations. *IEEE Trans. Cybern.* **46**, 1974–1985 (2016)
58. P. Burnap, M.L. Williams, Us and them: identifying cyber hate on Twitter across multiple protected characteristics. *EPJ Data Sci.* **5**, 1–15 (2016)
59. N. Oliveira, P. Cortez, N. Areal, The impact of microblogging data for stock market prediction: using Twitter to predict returns, volatility, trading volume and survey sentiment indices. *Expert Syst. Appl.* **73**, 125–144 (2017)
60. A. Singh, N. Shukla, N. Mishra, Social media data analytics to improve supply chain management in food industries. *Transp. Res. Part E Logist. Transp. Rev.* **114**, 398–415 (2018)
61. H. Wang, D. Can, A. Kazemzadeh, F. Bar, S. Narayanan, A system for real-time Twitter sentiment analysis of 2012 us presidential election cycle, in *Proceedings of the ACL 2012 System Demonstrations* (Association for Computational Linguistics, 2012), pp. 115–120
62. Understanding sentiment analysis: what it is & why it’s used. <https://www.brandwatch.com/blog/understanding-sentiment-analysis/>. Accessed 19 Oct 2018
63. E. Aboujaoude, M.W. Savage, V. Starcevic, W.O. Salame, Cyberbullying: review of an old problem gone viral. *J. Adolesc. Health* **57**(1), 10–18 (2015). <https://doi.org/10.1016/j.jadohealth.2015.04.011>
64. M.A. Campbell, Cyber bullying: an old problem in a new guise? *J. Psychol. Couns. Sch.* **15**(1), 68–76 (2005)
65. Tokunaga Following you home from school, A critical review and synthesis of research on cyberbullying victimization. *Comput. Hum. Behav.* **26**, 277–287 (2010). <https://doi.org/10.1016/j.chb.2009.11.014>

66. Centers for Disease Control and Prevention. Youth violence: technology and youth protecting your child from electronic aggression (2014), <http://www.cdc.gov/violenceprevention/pdf/ea-tipsheet-a.pdf>. Accessed 11 Sept 2017
67. P.K. Smith, J. Mahdavi, M. Carvalho, S. Fisher, S. Russell, N. Tippett, Cyberbullying: its nature and impact in secondary school pupils. *J. Child Psychol. Psychiatry* **49**(4), 376–385 (2008). <https://doi.org/10.1111/j.1469-7610.2007.01846>
68. G. Sarna, M.P. Bhatia, Content based approach to find the credibility of user in social networks: an application of cyberbullying. *Int. J. Mach. Learn. Cybernet.* **8**(2), 677–689 (2017)
69. All you need to know about anti-bullying laws in India, <https://blog.ipleaders.in/anti-bullying-laws/> Accessed 14 July 2018
70. Qing Li, Cyberbullying in high schools: a study of students' behaviors and beliefs about this new phenomenon. *J. Aggress. Maltreatment Trauma* **19**(4), 372–392 (2010). <https://doi.org/10.1080/10926771003788979>
71. Qing Li, Cyberbullying in high schools: a study of students' behaviors and beliefs about this new phenomenon. *J. Aggress. Maltreatment Trauma* **19**(4), 372–392 (2010). <https://doi.org/10.1080/10926771003788979>
72. J. Wang, T.R. Nansel, R.J. Iannotti, Cyber bullying and traditional bullying: differential association with depression. *J. Adolesc. Health* **48**(4), 415–417 (2011)
73. M.P. Hamm, A.S. Newton, A. Chisholm, J. Shulhan, A. Milne, P. Sundar et al., Prevalence and effect of cyberbullying on children and young people: a scoping review of social media studies. *JAMA Pediatr.* **169**(8), 770–777 (2015). <https://doi.org/10.1001/jamapediatrics.2015.0944>
74. J.A. Casas, R. Del Rey, R. Ortega-Ruiz, Bullying and cyberbullying: convergent and divergent predictor variables. *Comput. Hum. Behav.* **29**, 580–587 (2013). <https://doi.org/10.1016/j.chb.2012.11.015>
75. Commissariato di PS, Una vita da social, https://www.commissariatodips.it/uploads/media/Comunicato_stamp_a_Una_vita_da_social_4_edizione_2017.pdf. Accessed 28 Nov 2017
76. Law n. 71/17 of 29/05/2017, GU n. 127 of 03/06/2017. Senatodella Repubblica, <http://www.senato.it/leg/17/BGT/Schede/Ddliter/43814.htm>. Accessed 11 Sept 2017
77. Bsecure, <http://www.safesearchkids.com/BSecure.html>
78. Cyber Patrol, <http://www.cyberpatrol.com/cpparentalcontrols.asp>
79. eBlaster, <http://www.eblaster.com/>

Advertisement Prediction in Social Media Environment Using Big Data Framework



Krishna Kumar Mohbey, Sunil Kumar and Vartika Koolwal

Abstract With the development of mobile technologies and IOT devices, the world has stepped into the era of big data and social media as well. Having collected data from social media, business companies can easily understand behavior and buying patterns of the individual customers. The data is being collected via machine learning algorithms and social media platforms. A prediction mechanism is needed to process these larger data. Based on the results generated by big data framework, business companies can directly target individuals for sending advertises. In this chapter, an advertisement prediction framework has been proposed that uses prediction approaches on big data platforms. In addition, social media platforms are used to collect data that is based on user interest. The experiments has been performed on real-time data that is collected from social media platforms. The introduced framework can be served as a benchmark for business companies to send appropriate advertisement to the individuals.

Keywords Social media · Big data · IoT · Advertisement prediction · Prediction approaches · MapReduce

K. K. Mohbey (✉) · S. Kumar · V. Koolwal
Central University of Rajasthan, Kishangarh, India
e-mail: kmohbey@gmail.com

S. Kumar
e-mail: 2sunil.cs@gmail.com

V. Koolwal
e-mail: vartikakoolwal14@gmail.com

© Springer Nature Singapore Pte Ltd. 2020
S. Tanwar et al. (eds.), *Multimedia Big Data Computing for IoT Applications*, Intelligent Systems Reference Library 163,
https://doi.org/10.1007/978-981-13-8759-3_12

1 Introduction

The escalating growth and betterment of cellular communication technologies, IoT (Internet of Things), and portable sensor network have created various opportunities for business companies. In the present scenario, online purchasing behavior is elevating day by day. Business companies are interested to know about the customer interest, their behavior, and purchasing pattern. In addition to the online activities of customers and companies, big data also plays a significant role to enhance the facilities and business. Big data can be used to target people according to their behavior activities. It ultimately saves money and increases efficiency by targeting the right people with the right product.

A customer's online activity such as searching products, online purchasing, and providing products reviews increases values to the marketing and advertising. There is such a vast amount of activity information that are generating every second, which is acknowledged as the big data.

Social media forum such as Twitter, Facebook, Youtube, and review sites are currently the key sources to generate big data. These collected data are unstructured and large in quantity that so various algorithms and strategies are needed to handle such kind of collected data. Most of the giant business companies already started to use big data technologies for their product advertisements as well as sales and marketing [1].

The aim of these business companies is to target the consumers for selling their products according to their choice and activities. Various prediction and classification approaches can be used for advertisement within big data frameworks. To predict target advertisement, different parameters such as user's preference, location history, user's review, and search patterns can be used [2].

This chapter addresses the strong demand for advertisement prediction based on social media review/tweet using big data analytic approaches. In this chapter, big data is obtained from Twitter using Twitter API with different hashtags. Among the obtained large amount of big data, prediction approaches have been applied to generate an appropriate advertisement for specific users.

The target of this chapter is to analyze big data, coming from Twitter or any other social media sources. The outcome will predict advertisement for business enhancement. Based on the predicted results, business companies can take appropriate decision for enhancing their business. It includes introducing a new product in the market, stopping sales of a product, increasing product quantities as well as product price fixing. This chapter presents our big data analysis framework for advertisement prediction with data collection from social sites.

The plot of this paper is presented in the following manner. Section 2 explores the fundamental ideas and methods for big data technologies for advertisement prediction. Section 3 describes a description of the social media platform and data collection methods. It also illustrates various methods of data processing. Section 4 presents our proposed framework for advertisement prediction using big data technologies. It also depicts several classification methods, used for prediction of advertisement.

Section 5 reports experimental results and discussion about the proposed work. Section 6 will be concluding the outcome and future possibilities.

2 Big Data and Advertisement Prediction

Social media is the main source of information toward big data technology enhancement. Currently, millions of users are expressing their views and put forward their opinion about a product or service on such platform. The big data technologies have achieved value due to huge data produced by these mediums. These technologies are adequate for handling such kind of vast data. There are lots of application areas where big data technologies are currently used. These applications include health care, education, smart city, smart transportation, traffic management, advertisement, marketing, and so on. Big data technologies are capable of handling data storage, data accessing, and producing appropriate solutions [3].

There are many techniques available for big data such as association rule mining, clustering, classification, prediction, and data analysis. These techniques use machine learning algorithms as well as data mining approaches.

Francis X was the first person to introduce the idea of big data. Diebold in 2000 [4] with the rapid development and enhancement in the internet, sensors, wireless network, and social networking. Due to these developments, the volume of data is increasing rapidly. This generated data is more complex and unstructured [3, 5]. Another important enhancement in technology is smartphone, mobile devices, and online transactions. At present, more than 50 GB data are generating per second, and it will increase gradually in the future [6].

2.1 *Big Data and its Characteristics*

The big data framework may collect, store, process, and produce the required solutions to the specific problem in various domains. It is also capable of making predictive analysis to enhance business via advertisement recommendations. Big data framework is also helpful for decision makers to make new decision and strategies. Four V's (Variety, Volume, Velocity, and Value) are the fundamental features of big data [7–9]. These V's are shown in Fig. 1.

2.1.1 Volume

Volume is the fundamental aspect of big data. It refers to the quantity of data that is being generated by different sources and applications. The main source of increasing volume is social networking applications such as Youtube, Facebook, Twitter, and online transactions [10].

Fig. 1 4 V's of Big Data

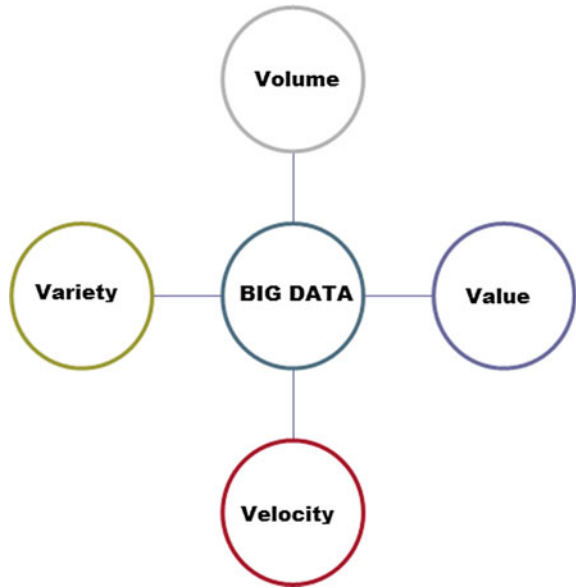

2.1.2 Velocity

It is pertaining to the speed of data generation and transfer as well. The velocity of data may be high or low. Some applications required high-velocity data, which is closer to the real-time data processing. Sometimes velocity can be more important than volume because it can give us a bigger competitive advantage. For instance, Youtube shows the velocity of big data [11].

2.1.3 Variety

It indicates the heterogeneity of data which is generated by the different sources. The generated data may be structured, unstructured or semi-structured. Perhaps, nearly, all the big data are unstructured. Big data are fusion of multiple forms of data such as audio, video, document, text, tweet, review, comments, logs, social media updates, sensor data, and clickstream [11].

2.1.4 Value

Value being the vital characteristic of big data. All other characteristics are meaningless if the data doesn't have a value. There are various research techniques to obtain value from the collected data. To find a value from available data requires new analytics and approaches [10].

2.2 *Big Data Technologies*

Presently, big data analytics has become very significant due to its processing power and capabilities of handling huge amount of data. The first open-source big data analytics framework for distributed computing, which includes HDFS, i.e., a distributed file system and MapReduce processing unit. Apache Hadoop is apparently the most popular and standard big data framework at present [12]. On the other hand, some platforms have more leverage to the standard Hadoop implementation. Hadoop is not capable of handling dynamic information in the real-time analysis. Besides Hadoop, the storm is a stream processing engine which focuses on incremental computing. It is an also open-source framework that was developed to process Twitter reviews [13].

Furthermore, Spark is another big data analytics, which enables in-memory computation with higher performance than Hadoop. It is coded in Scala, which allows it to work on single data processing engine. It also supports iterative jobs [14]. Nowadays, advertisement prediction has become an interesting research issue for business enhancement. Various business companies want to provide an appropriate advertisement to the consumer based on their needs and preferences. Unlike traditional advertisement system, recent advertisement strategies focus on target a specific group of peoples. Therefore, big data frameworks have taken a place to predict certain advertisement on real-time Twitter data.

3 **Data Collection Through Social Media**

Today, people are acquainted with multiple social networking sites at a rapid rate. It is playing a crucial role in acquiring sharing information in multiple forum such as feedback for a product or service [15]. We can transfer different kinds of data via social media platform including text, image, video, audio, and files. Social media has opened plenty of opportunities for examining data and resulting in various outcome.

One of the major aspects of social media analytics is predicting advertisement to enhance business. Moreover, it also contributes in decision-making. It includes real-time data collection via social media blogs or sites such as Twitter to store in big data storage format like HDFS or RDD (Resilient Distributed Datasets).

To perform advertisement prediction in big data framework, Twitter is the main source of data collection, which provides the facility to write a review or opinion about any topic or product. It has been reported that Twitter have more than 330 million monthly active users in the first quarter of 2019 [16].

Twitter API is used to collect tweet using given hashtag such as #mobile, #vivo, #iphone, and #samsung. In this API, it is needed to create an application first with four secret keys. These keys are important for fetching Twitter data. After creating Twitter API, live tweets can be directly fetched in the big data environment. Flume is a distributed and reliable engine for acquiring a huge number of tweets from Twitter

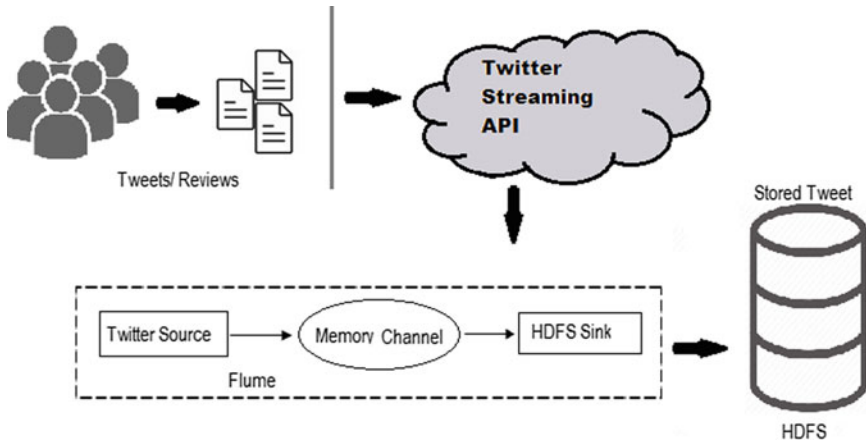

Fig. 2 Data collection from twitter

text	favorited	replyToInCreated	truncated	replyToId	id	replyToId	statusSourceName
1 the first 5G-upgradable phone - Moto 2 ⁺ with moto mods.	FALSE	NA	15-11-2018 01:38	TRUE	NA	106288251690600000.00	NA <@ href="">sunstonit
2 Looking for a better method of #communication for your next event? Our team can	FALSE	NA	14-11-2018 21:58	TRUE	NA	1062827066272310000.00	NA <@ href="">MRC5Y
3 @JuddLegum @Google Typing this on a @Google Pixel XL. Retweeting YUGELY my chi	FALSE	JuddLegum	14-11-2018 21:57	FALSE	1.063E+18	1062826927218710000.00	15464697 <@ href="">minamou
4 #Motorola, Verizon Successfully Test 5G Data On #Moto2 ⁺ https://t.co/8Mxv05Io	FALSE	NA	14-11-2018 20:32	FALSE	NA	106280549629220000.00	NA <@ href="">takesonte
5 #Motorola in 2 pieces-I type too hard so it kept opening up further and further. Th	FALSE	NA	14-11-2018 17:21	TRUE	NA	1062734616155120000.00	NA <@ href="">kearrighz
6 Verizon has announced successfully connecting a smartphone to its 5G network in	FALSE	verizon	14-11-2018 17:18	TRUE	NA	106275672385000000.00	59889953 <@ href="">LUE_LUC
7 Top 100 Exclusive Smart Phones: Short listed to find your one <U>#U+0001F6E2</U>#U+0001	FALSE	NA	14-11-2018 17:12	TRUE	NA	1062755038211330000.00	NA <@ href="">Emalstratj
8 #BigBigAlert <U>#U+0001F6A0</U> I'm starting to get that feeling that I'm buying #M	FALSE	BigBig_Tri	14-11-2018 17:01	TRUE	1.062E+18	1062752402174950000.00	534812541 <@ href="">BigBig_Tri
9 @RedmiIndia @XiaomiIndia @xiaomi Any information about #MiMax3 launch in Ind	FALSE	RedmiInd	14-11-2018 16:38	TRUE	NA	10627546621862060000.00	3269020218 <@ href="">Enjoymytr
10 Top 100 Exclusive Smart Phones: Short listed to find your one <U>#U+0001F6E2</U>#U+0001	FALSE	NA	14-11-2018 16:36	TRUE	NA	106274611327790000.00	NA <@ href="">Anaiturr
11 @HonorIndia @HonorGlobal @HuaweiIndia Any news about #Honor8mas #Honor	FALSE	HonorIndr	14-11-2018 16:36	TRUE	NA	106274610117270000.00	3025239456 <@ href="">Enjoymytr
12 Top 100 Exclusive Smart Phones: Short listed to find your one <U>#U+0001F6E2</U>#U+0001	FALSE	NA	14-11-2018 16:20	TRUE	NA	1062741960811670000.00	NA <@ href="">SiuckeSdC
13 The Moto 2 ⁺ enters the world's first 5G network	FALSE	NA	14-11-2018 16:06	TRUE	NA	1062738508366910000.00	NA <@ href="">IMigles
14 Super challenging codewords puzzles in abundance. Download on Android!	FALSE	NA	14-11-2018 15:19	TRUE	NA	1062758598260070000.00	NA <@ href="">DevWillia
15 Verizon links a @MotorolaU5 Moto 2<U>#U+0001F4F1</U> to its 5G <U>#U+0001F4F6</U>	FALSE	NA	14-11-2018 14:39	TRUE	NA	1062716753342570000.00	NA <@ href="">T4k
17 #freshLabelDay should so be a hashtag. Long overdue hour with the #dymo machine	FALSE	NA	14-11-2018 14:15	TRUE	NA	1062710546015940000.00	NA <@ href="">andrew_j
18 @Apple Switched away from iPhone. Got a \$40 #motorola and could not be happier.	FALSE	Apple	14-11-2018 13:41	FALSE	1.053E+18	106270194017230000.00	380749300 <@ href="">annastellen
19 Moto X4 Android 9 pie Update Rolled out started in india https://t.co/jhND9NtD vi	FALSE	NA	14-11-2018 13:33	TRUE	NA	1062700127014470000.00	NA <@ href="">Iampirasac
20 Android 9 Pie update for the Moto X4 starts rolling out with the Build number	FALSE	NA	14-11-2018 12:41	FALSE	NA	1062686975621090000.00	NA <@ href="">Pctabletr
21 Real-time communications can strengthen staff and patient safety, elevate service	FALSE	NA	14-11-2018 10:10	TRUE	NA	1062648862651090000.00	NA <@ href="">WeArePeo
22 #Motorola #MotoX4 Now Getting @Android #Pie #Update in India	FALSE	NA	14-11-2018 08:11	TRUE	NA	1062618905884180000.00	NA <@ href="">Iatestly
23 CSR : Lenovo and Motorola step-up to support Govt.'s Skill India mission	FALSE	NA	14-11-2018 07:45	TRUE	NA	1062612338867230000.00	NA <@ href="">INDIACSR
24 Match three to free the teddies. Download on Android!	FALSE	NA	14-11-2018 07:38	TRUE	NA	10626105534817410000.00	NA <@ href="">DevWillia
25 Motorola's Android Pie update for Moto X4 weighs a little over 1.15GB in size.	FALSE	NA	14-11-2018 06:14	FALSE	NA	1062589515179740000.00	NA <@ href="">ITTimesIN

Fig. 3 Snapshot of tweets collected from Twitter

to HDFS environment [17]. It has a basic architecture, which works on live streaming data flow. Figure 2 shows the data collection process from Twitter.

When tweets are fetched from livestreams, it is unstructured and noisy. It needs to be preprocessed for further processing. Figure 3 shows a sample tweet collected from Twitter.

3.1 Preprocessing

Collected data needs to preprocess before analyzing and prediction. Preprocessing is a necessary step for data preparing before the process. As the downloaded tweets are noisy, skewed in nature, when it is acquired. Therefore, a preprocessing is needed to turn the raw data to the proper formats. Different processing methods have been used

for data preprocessing. This step includes stop word removal, stemming, and feature extraction. When this step is completed, processed data is ready for advertisement prediction [12].

3.1.1 Data Filtering

After collecting the unstructured Twitter data, we need to smooth it out by removing website URLs (https), eliminating hashtags (#), and discarding twitter mention (@username). Besides this, we need to discard, the common word RT, i.e., retweet. We need to take care of the additional white spaces, along with special characters. It will be quite convenient if we consider only distinct tweets and convert all the unique filtered tweets into lowercase for ease in further processes.

3.1.2 Stopword Removal

Some very common words like “is, am, are, to, we, this, that” has high occurrence which holds no feature information. So, it’s better to remove such words resulting in reducing the clutter from tweets. We can achieve it by using the available list of stopwords. To remove stopword, we compare each word of the tweets from available stopword list. We eliminate the words inside the tweets which match from the list [19].

3.1.3 Stemming

Stemming is the process of substituting the derived word with their root word. For example words like amusing, amusement, and amused will be replaced by amus, by Porter algorithm. Using stemming, we can get the root word which helps in the analysis of tweets [19].

3.1.4 Feature Extraction

First, we perform tokenization to extract features. Tokenization is the process of creating individual terms by splitting the sentences. Second, we use tF-IDF method, which is used for feature vectorization in text mining to depicts the significance of the term in the document. Third, we implement Word2Vec estimator, which generate Word2Vector model by taking a sequence of words representing a document. The model associates each word to the distinct vector. The model changes all the documents using the averaging of every term in the document into a vector; this vector then is used as a feature for prediction or document similarity [19–21]. Lastly, CountVectorizer and CountVectorizer model seek to convert a group of a text document to token count vector.

Table 1 Refined tweets with classes

#	Tweet	Class
1	Super challeng codeword puzzl abundance download androidbrain fun	Positive
2	Announc success connect smartphone g network partnership samsung	Positive
3	Typepixel xl regret yugeli choic phone purchase missphone motorola	Negative
4	Total free total challenging get free googl play phone mobileapp tablets	Positive
5	Lightshot phonemotographi motogplus Delhi diwali light motorola	Neutral
6	When launch new phone feature p processor	Neutral
7	Slow motion option camera pleas	Negative
8	Im use colour os bad poor os	Negative
9	I think curious os come realm devices	Neutral
10	Batteri life realmpro great even good just like iphone	Positive

After applying preprocessing methods, we have refined tweets, which can be further used for classification and prediction. In the training set of tweets, we have also assign classes to each tweet. The class assignment has been carried out with the help of a tweet score. Here, classes are positive, negative, and neutral. Table 1 shows an example of refined tweets with their classes.

4 Advertisement Prediction Framework

In this section, we have proposed an advertisement prediction framework, which shows the complete process of prediction. This framework is based on big data technologies such as Hadoop, Spark, and related approaches. After collecting livestream twitter data, different machine learning approaches has applied. Here, advertisement prediction has been performed using well-known machine learning approaches such as Naive Bayes classification, SVM (support vector machine), random forest, logistic regression, and decision tree. The complete architecture of the advertisement prediction using social media data is shown in Fig. 4.

The first step of this architecture is to collect tweets from Twitter. Different tweets related to advertisement have gathered from Twitter using Twitter API and Flume. These collected tweets are stored in the big data environment in HDFS or RDD formats. This data is unstructured and also have noise; therefore, it is needed to perform preprocessing steps. It includes stopword removal and stemming. After data cleaning, useful features are again stored in the proper format, i.e., HDFS or RDD format. In the next step, these refined tweets are classified using different

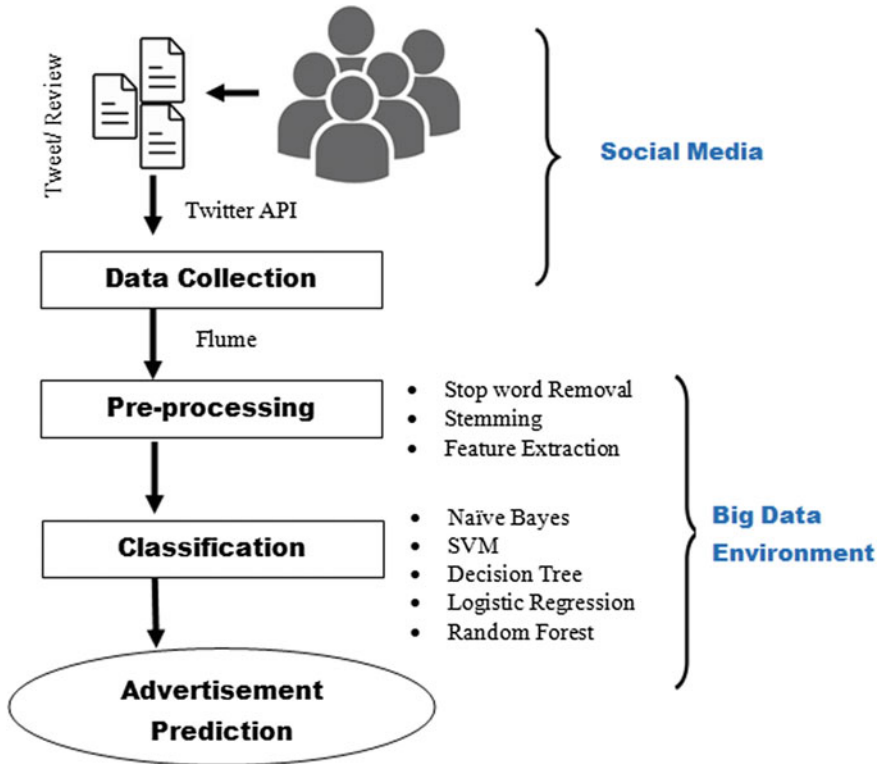

Fig. 4 Advertisement prediction framework

well-known supervised classification approaches. Based on the classification results of these approaches, appropriate advertisement recommendation can be made to a specific group of peoples. This step is known as the prediction under this architecture. The description of these classification approaches is given below.

4.1 Naive Bayes Classifier

It is a prominent, probabilistic, and supervised classification approach. It focuses on the application of Bayes theorem with naive (high) nondependent assumptions among the attributes. It is use to predict the probability for a tweet to reside in a particular class [22, 23]. This model discovers the tweet’s sentiment as positive, neutral, or negative.

$$P(C | d) = \frac{P(d | C) \cdot P(C)}{P(d)} \tag{1}$$

where

C: specified class

D: tweet wants to classify

$P(C)$ and $P(d)$: prior probabilities

$P(C | d)$: Posterior probability

Given tweet data points $D = d_1, d_2, \dots, d_i$, which are required to be classified in class C. The numerical equation of Naive Bayes $P(C/D)$ is as follows:

$$P(C | d) = P(C) \cdot P\left(\frac{d_i}{C}\right) \quad (2)$$

4.2 SVM Classifier

SVM is a supervised learning model developed by Vapnik [24]. They are applied on data set to examine for classification and regression. The SVM model is used to predict the class of the new examples based on the marked labels learned from the training data. It is binary, linear and non-probabilistic classifier [25]. In linear SVM, we have N points of training examples such as $(x_1, y_1), \dots, (x_N, y_N)$ where an example x_i is representing a vector R^N and the class label y_i has value either -1 or 1 . We need to identify the hyperplane that separates the negative instance from that of positive ones with an optimum margin. That optimal margin is the maximum distance of the hyperplane to the closest of the negative instance and positive set of examples [26]. Figure 5 displays an instance of SVM classifier. In this figure, there are two classes—blue triangle and pink parallelogram. It also has three hyperplanes, in which dark line signify possible best separation among these two classes. In the division, the normal distance of every data point is the largest. Therefore, it presents the maximum margin of separation.

4.3 Decision Tree

It is a decision support technique which is one of the widely applied supervised classification techniques due to its high accuracy [27]. It has a flowchart-like structure with its internal nodes to represent a “test” condition, each branch indicates the result of the test condition and every leaf node depicts a class label which is the decision undertaken. It follows top to down approach representing the classification rule. Figure 6 shows an example of decision tree.

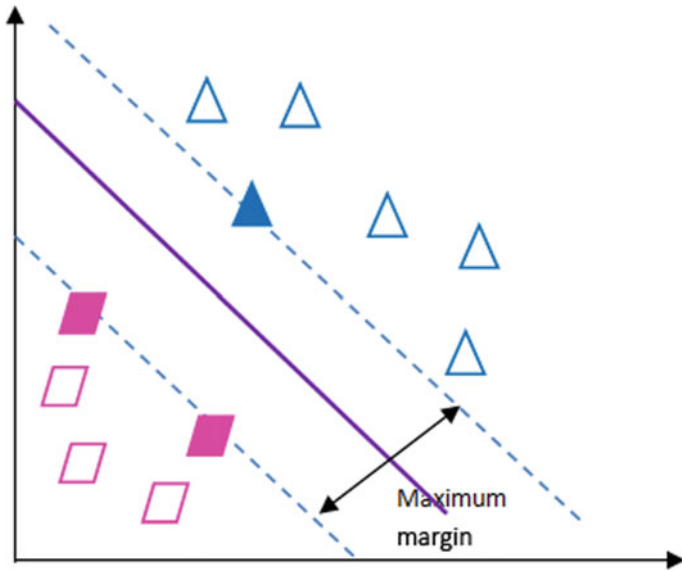

Fig. 5 Support vector machine classification

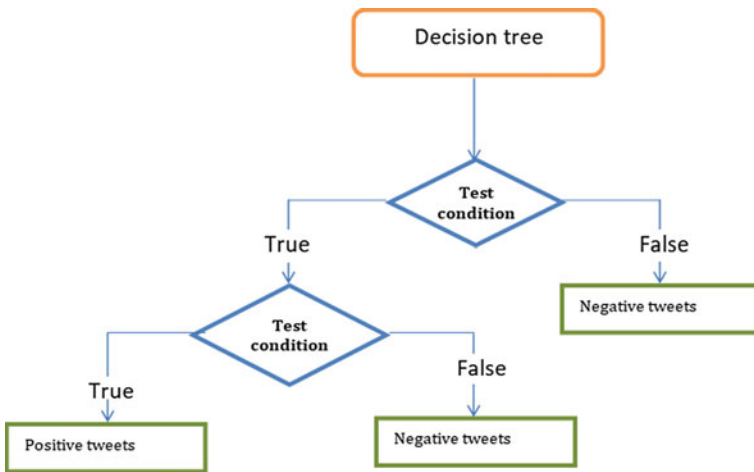

Fig. 6 Decision tree classification

If the classes along with its attributes are given, a decision tree generates a series of rules or sequence of questions that are used to identify the class. To measure impurity, we can use entropy which is a measure of uncertainty related to a random variable. The entropy is directly proportional to the uncertainty or randomness. Entropy has its value between 0 and 1.

Let's define entropy on given collection T , $Entropy(T)$ is defined as

$$Entropy(T) = \sum_{j=1}^c -p_j \cdot \log_2 p_j \quad (3)$$

where, p_j is the probability that an random row in T refer to class X and is given by $\frac{|C_{j,x}|}{|T|}$. A base log 2 method implies as entropy is concealed into bits 0 and 1.

We use Information Gain measure to bring out the best attribute for a node . The information gain, of an attribute, is

$$Gain(T, A) = Entropy(T) - \sum_{j=1}^v \frac{|T_j|}{|T_v|} \cdot Entropy(T_j) \quad (4)$$

where

T : given data set

A : Attribute

V : Using attribute A , the tuples in T are partition with d unique values.

T : is divided into d subsets, (T_1, T_2, \dots, T_j) where T_j consists of only that tuples in T which has result of A .

The attribute that has the maximum information gain is selected.

4.4 Random Forest Classifier

It is a kind of ensemble learning method that renders predictions by averaging the predictions of multiple independent base models. Since its creation by Breiman [28] the random forests as a classifier for regression and classification purpose has been extremely successful. It consists of a group of tree-like classifier where independent random vector are dispersed identically, and every tree cast a single vote for the most favored class. A random vector is formed that is independent of the earlier vector for the same distribution resulting in the generation of the tree [28]. The random forest has certain advantages over another classifier such as it doesn't suffer from the problem of overfitting [29], the same random forest algorithm can be used for classification and regression, and it can be used for feature engineering, i.e., selecting the most important features from the available features of the training set.

4.5 Logistic Regression

Logistic regression is a well-known predictive analysis approach. It is mostly used when data is binary. It is used to analyze the data and its relationship of one binary dependent variable, with multiple ordinal, nominal, ratio-level, or interval independent variables. The dependent data has values such as win/lose, on/off, and true/false from which are considered as indicator variables [30]. Linear model has log odds (logarithm of the odds) for the value tagged as “1” is the fusion with another independent variable (predictors).

5 Results and Discussion

The performance of our proposed approach has been measured regarding accuracy, precision, and recall. Different experiments have been carried out to bring out the effectiveness of the approach in different perspectives. We have conducted all the experiments on big data platform, i.e., Spark. The effectiveness of advertisement prediction has been tested using SVM, Logistic Regression, Naive Bayes, Decision Tree, and Random Forest Approach.

5.1 Performance Evaluation

To critically analyze the performance of classification approaches, the collected data is partitioned into 70 and 30% vis-a-vis training and testing, respectively. To enhance the performance of experimental evaluation, we have removed all the tweets that have neutral classes because it decreases the accuracy of the classification models. The performance of the proposed approaches has been measured by different parameters such as accuracy, precision, recall, and F-measure. Table 2 shows a 2×2 confusion matrix of positive and negative instances.

According to positive and negative instances, the performance can be measured. The following equations show the performance parameters:

$$Precision = \frac{TP}{TPP} \quad \text{Where, } TPP(\text{Total Predicted Positive}) : TP + FP \quad (5)$$

Table 2 Confusion matrix

		Predicted class	
		Negative (0)	Positive (1)
Actual class	Negative (0)	True Negative (TN)	False Positive (FP)
	Positive (1)	False Negative (FN)	True Positive (TP)

$$Recall = \frac{TP}{TAP} \text{ Where, } TAP(\text{Total Actual Positive}) : TP + FN \tag{6}$$

$$Accuracy = \frac{TP + TN}{TPP + TPN} \text{ Where, } TPN(\text{Total Predicted Negative}) : TN + FN \tag{7}$$

$$F1 = \frac{2 \cdot Precision \cdot Recall}{Precision + Recall} \tag{8}$$

Furthermore, the performance of different machine learning classification approaches is portrayed in Table 3, Table 4, Table 5, and Table 6, respectively.

Table 3 Performance comparison (Tweet size = 10k)

Classification approach	Accuracy	Recall	F1-measure	Precision
Naive Bayes	0.84337	0.84337	0.84347	0.84482
SVM	0.87184	0.87184	0.87179	0.87205
Decision tree	0.65418	0.65418	0.60165	0.76818
Logistic regression	0.86420	0.86418	0.86418	0.86426
Random forest	0.70385	0.70385	0.68375	0.76562

Table 4 Performance comparison (Tweet size = 20k)

Classification approach	Accuracy	Recall	F1-measure	Precision
Naive Bayes	0.83813	0.83813	0.84265	0.85077
SVM	0.86387	0.86387	0.85476	0.86004
Decision tree	0.81283	0.81283	0.76944	0.82376
Logistic regression	0.87580	0.87580	0.87231	0.87187
Random forest	0.75708	0.75708	0.65471	0.65523

Table 5 Performance comparison (Tweet size = 30k)

Classification approach	Accuracy	Recall	F1-measure	Precision
Naive Bayes	0.81609	0.81609	0.81678	0.81859
SVM	0.85489	0.854889	0.85451	0.85451
Decision tree	0.62328	0.62328	0.51552	0.75617
Logistic regression	0.85799	0.85799	0.85788	0.85781
Random forest	0.64122	0.64122	0.55422	0.75671

Table 6 Performance comparison (Tweet size = 40k)

Classification approach	Accuracy	Recall	F1-measure	Precision
Naive Bayes	0.82511	0.82511	0.82755	0.83226
SVM	0.85176	0.85176	0.84723	0.84973
Decision tree	0.73037	0.73037	0.65481	0.78226
Logistic regression	0.86117	0.86117	0.85932	0.85905
Random forest	0.71177	0.71177	0.61697	0.79019

5.2 Comparison of Different Machine Learning Approaches

In this subsection, we have compared different machine learning classification approaches under the big data framework. This comparison is done under different parameters. Figures 7 and 8 show the comparison of different approaches concerning training and prediction time on different sizes of tweets.

Figure 7 describes that Naïve Bayes takes less time for the training model. Similarly, random forest classification takes more time to prepare the model. This figure also describes that when tweet size increases, training time is also increased.

Figure 8 shows prediction time comparison results of all approaches. This figure indicates that logistic regression takes less time to perform prediction. All other approaches approximately take a similar time to predict results.

Accuracy comparison of all the approaches is shown in Fig. 9. This figure describes that logistic regression performs best for larger data sizes. When tweet size is 10k,

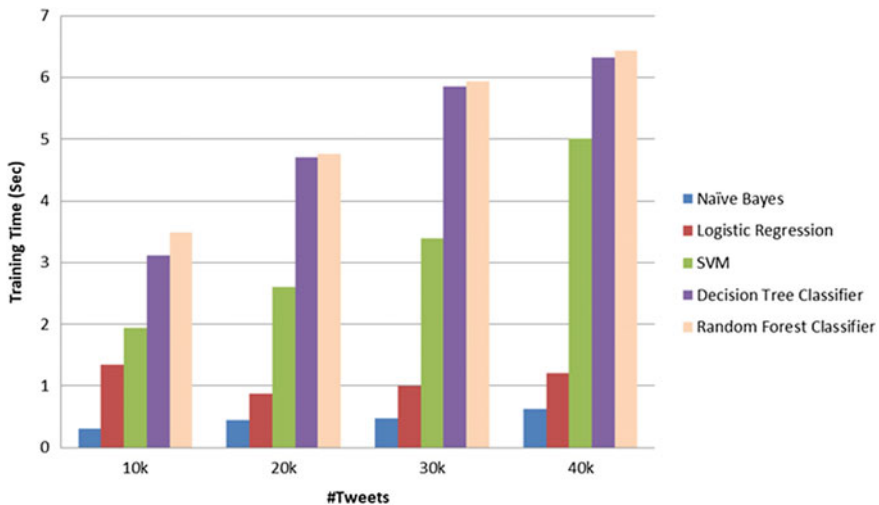

Fig. 7 Training time comparison

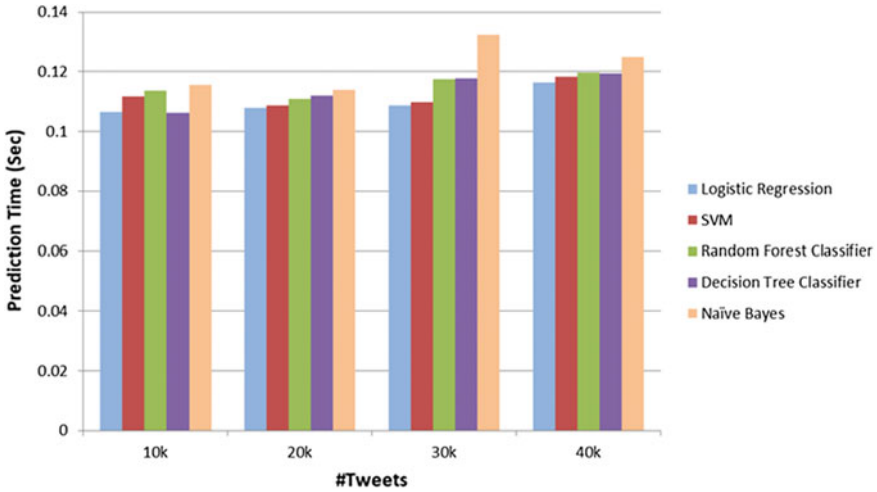

Fig. 8 Prediction time comparison

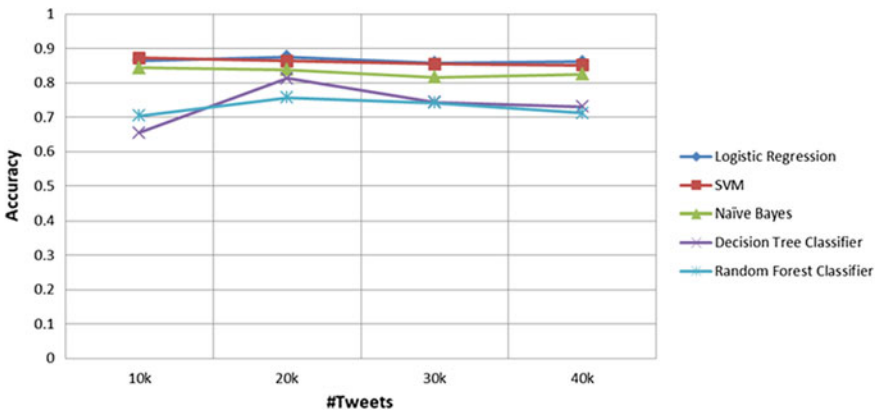

Fig. 9 Accuracy comparison

SVM has higher accuracy, i.e., 87%. But when data size increased to 29, 30k and above logistic regression have higher accuracies such as 87, 85, 86%, and so on.

Another comparison is done on AUC (area under the curve). This comparative results value as shown in Table 7. It shows the classification analysis to determine which of the model predicts the best classes. Based on this analysis, Fig. 10 shows that SVM and logistic regression, both classification approaches perform best, compared to other approaches.

Table 7 AUC results

Classification approach	10k	20k	30k	40k
Naive Bayes	0.44885	0.53668	0.51922	0.50106
SVM	0.936209	0.90786	0.92343	0.91386
Logistic regression	0.9354744	0.91665	0.92731	0.92216
Decision tree classifier	0.45938	0.47716	0.62903	0.55181
Random forest classifier	0.8053398	0.81072	0.82305	0.81109

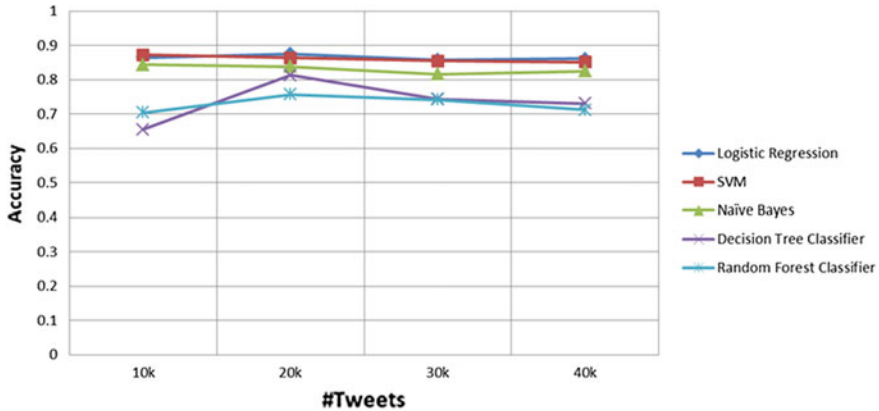

Fig. 10 AUC comparison

6 Conclusions and Future Work

Exploring the notion of social media and big data technologies together, the contribution of advertisement prediction has been proposed. Unlike previous studies, the issues of handling huge data are also discussed. The objective of this chapter is to propose a framework for advertisement prediction. The big data has been collected from Twitter as user tweets. Then, various preprocessing methods have applied to clean that data. Various well-known classification approaches are used to predict appropriate advertisement for a specific or group of users. Based on a user tweet, its class is predicted. If the predicted class is positive, then advertisement can be recommended to that particular user. The performance has been analyzed by above-mentioned classifier approach on different sizes of data. The experimental results show that logistic regression has higher accuracy as compared to other approaches.

In the future, this work can explore multiple categories of data on different social media review such as e-commerce review and blog reviews. Also, we can work to enhance prediction accuracy with big data tools.

References

1. L. Deng, J. Gao, An advertising analytics framework using social network big data, in *Information Science and Technology (ICIST)*, pp. 470–475 (IEEE, 2015)
2. J. Bao, Y. Zheng, M. F. Mokbel, Location-based and preference-aware recommendation using sparse geo-social networking data, in *Proceedings of the 20th International Conference on Advances in Geographic Information Systems*, pp. 199–208 (ACM, 2012)
3. Natalija Koseleva, Guoda Ropaite, Big data in building energy efficiency: understanding of big data and main challenges. *Proc. Eng.* **172**, 544–549 (2017)
4. F.X. Diebold, Big data dynamic factor models for macroeconomic measurement and forecasting, in *Advances in Economics and Econometrics: Theory and Applications, Eighth World Congress of the Econometric Society*, ed. by M. Dewatripont, L.P. Hansen, S. Turnovsky, pp. 115–122 (2003)
5. Abdulkhaliq Alharthi, Vlad Krotov, Michael Bowman, Addressing barriers to big data. *Bus. Horiz.* **60**(3), 285–292 (2017)
6. B. Walker, Every day big data statistics–2.5 quintillion bytes of data created daily. *VCloudNews* April 5 (2015)
7. E. Al Nuaimi, H. Al Neyadi, N. Mohamed, J. Al-Jameela, Applications of big data to smart cities. *J. Internet Serv. Appl.* **6**(1), 25 (2015)
8. Krishna Kumar Mohbey, The role of big data, cloud computing and IoT to make cities smarter. *Int. J. Soc. Syst. Sci.* **9**(1), 75–88 (2017)
9. Umit Can, Bilal Alatas, Big social network data and sustainable economic development. *Sustainability* **9**(11), 2027 (2017)
10. An Enterprise Architect’s Guide to Big Data, Oracle (2017). <http://www.oracle.com/technetwork/topics/entarch/articles/oea-big-data-guide-1522052.pdf>. Accessed on 15 Sept 2017
11. A. Oussous, F.Z. Benjelloun, A.A. Lahcen, S. Belfkih, Big data technologies: a survey. *J. King Saud Univ. Comput. Inf. Sci.* (2017)
12. J. Liu, X.X. Chen, L. Fang, J.X. Li, T. Yang, Q. Zhan, K. Tong, Z. Fang, Mortality prediction based on imbalanced high-dimensional ICU big data. *Comput. Ind.* **98**, 218–225 (2018)
13. V.S. Agneeswaran, *Big Data Analytics Beyond Hadoop: Real-time Applications with Storm, Spark, and More Hadoop Alternatives* (FT Press, 2014)
14. Jorge L. Reyes-Ortiz, Luca Oneto, Davide Anguita, Big data analytics in the cloud: spark on hadoop vs mpi/openmp on beowulf. *Proc. Comput. Sci.* **53**, 121–130 (2015)
15. Stefan Stieglitz, Milad Mirbabaie, Björn Ross, Christoph Neuberger, Social media analytics-challenges in topic discovery, data collection, and data preparation. *Int. J. Inf. Manag.* **39**, 156–168 (2018)
16. Statista (2019) Number of monthly active Twitter users worldwide from 1st quarter 2010 to 1st quarter 2019 (in millions). <https://www.statista.com/statistics/282087/number-of-monthly-active-twitter-users/>. Accessed 2 June 2019
17. Alexander Pak, Patrick Paroubek, Twitter as a corpus for sentiment analysis and opinion mining. In: *LREc* vol. 10, pp. 1320–1326 (2010)
18. H.A. Alaka, L.O. Oyedele, H.A. Owolabi, M. Bilal, S.O. Ajayi, O.O. Akinade, A framework for big data analytics approach to failure prediction of construction firms. *Appl. Comput. Inf.* (2018)
19. C.C. Aggarwal, C.X. Zhai (eds.), *Mining Text Data* (Springer Science & Business Media, New York, 2012)
20. M. Hu, B. Liu, Mining and summarizing customer reviews, in *Proceedings of the Tenth ACM SIGKDD International Conference on Knowledge Discovery and Data Mining*, pp. 168–177 (ACM, 2004)
21. C. Whitelaw, N. Garg, S. Argamon, Using appraisal groups for sentiment analysis, in *Proceedings of the 14th ACM International Conference on Information and Knowledge Management*, pp. 625–631 (ACM, 2005)

22. K.K. Mohbey, B. Bakariya, V. Kalal, A study and comparison of sentiment analysis techniques using demonetization: case study, in *Sentiment Analysis and Knowledge Discovery in Contemporary Business*, pp. 1–14 (IGI Global, 2019)
23. Walaa Medhat, Ahmed Hassan, Hoda Korashy, Sentiment analysis algorithms and applications: a survey. *Ain Shams Eng. J.* **5**(4), 1093–1113 (2014)
24. Corinna Cortes, Vladimir Vapnik, Support-vector networks. *Mach. Learn.* **20**(3), 273–297 (1995)
25. V. Vapnik, *The Nature of Statistical Learning Theory* (Springer Science & Business Media, New York, 2013)
26. J. Gimenez, L. Marquez, SVMTool Technical Manual v1. 3 (2006)
27. B. Nithyasri, K. Nandhini, E. Chandra, Classification techniques in education domain. *Int. J. Comput. Sci. Eng.* **2**(5) (2010)
28. Leo Breiman, Bagging predictors. *Mach. Learn.* **24**(2), 123–140 (1996)
29. J. Friedman, T. Hastie, R. Tibshirani, *The elements of statistical learning*, vol. 1, no. 10 (Springer Series in Statistics, New York, 2001)
30. D.R. Cox, The regression analysis of binary sequences. *J. R. Stat. Soc. Series B (Methodological)* 215–242 (1958)

MMBD Sharing on Data Analytics Platform



Manish Devgan and Deepak Kumar Sharma

Abstract This chapter explores the field of Multimedia Big Data sharing on Data analytics platform. Multimedia data is a major contributor to the big data bubble. It is produced so that it can be shared among family, friends and even masses. Sharing of media data can be done in various ways and all of them have been covered in this chapter. Further, the chapter covers cloud services as a recently developed area for storage and computation. Impacts of social media giants like Facebook and Twitter along with Google Drive have been discussed. The chapter ends with a brief mention of security of online data and analysing the MMBD.

Keywords Big Data · Sharing · Wireless sharing · WLAN sharing · Image sharing · Cloud and benefits · Data analytics · Google cloud · Facebook · Sharing media data

1 Introduction

Since the mid-2000s, multimedia storing and sharing websites and services, such as Yahoo Flickr, Google photos, Dropbox, and Apple iCloud, have played a critical role in digital multimedia management. Nowadays, users have the availability of various platforms that allow them to create, manage and backup a huge amount of data. This data can be created from as simple as a smartphone to as complex as a social network such as Facebook. Facebook alone is responsible for generating 2.5 billion pieces of content and 500+ terabytes of data almost every day [1].

As multimedia data are increasing exponentially, the services that offer data sharing are providing the users with lots of options to choose from. Unlimited storage,

M. Devgan · D. K. Sharma (✉)
Division of Information Technology, Netaji Subhas University of Technology, (Formerly Known as NSIT), New Delhi, India
e-mail: dk.sharma1982@yahoo.com

M. Devgan
e-mail: manish.nsit8@gmail.com

© Springer Nature Singapore Pte Ltd. 2020
S. Tanwar et al. (eds.), *Multimedia Big Data Computing for IoT Applications*, Intelligent Systems Reference Library 163,
https://doi.org/10.1007/978-981-13-8759-3_13

unlimited bandwidth limits, and maximum file upload sizes are just to name a few. There are services that offer a platform for sharing multimedia data to not just close-by people but also to masses. There is analytics engine that run behind these sharing services that makes ‘sense’ out of data to enhance the customer experience. Platforms could range from being a simple website or a cloud service to a more complex mobile application.

In this chapter, we will discuss on the topic of sharing multimedia data. The chapter will work on enticing the reader with the possibilities associated with the big data world. We will read about how multimedia is shared among people and will further discuss about storing this data. A brief note on security of this data will also be considered in this chapter.

We will end with discussing the Multimedia Big Data Analysis and how it helps everyone.

Finalizing the chapter will be a conclusion containing a wrap-up of the chapter.

1.1 Characteristics of Big Data

Data is, as stated above, is information that has been translated into a form that is efficient for movement or processing. Big data is characterized by the leading ‘Big’ in front of the data. This ‘big’ defines the volume of the data that has to be processed. Today, the human population generates a huge chunk of data online which is being dumped onto the servers in valleys far away from the original source of creation.

Big data doesn’t always need to be structured, i.e. be in a proper format but can also be unstructured. Here, we are only concerned with the volume of the data being produced and not the content that is being generated by a particular user or a device connected to the internet. Data, in general, saw a huge boom after the common man was introduced to the devices such as laptops and mobiles which are usually connected to the internet either wirelessly or through some wired connection. Tens of quintillion bytes of data are being generated every day and this is not just ASCII text data but also comprises of multimedia data such as audio messages, music, images, videos and even animations. This main contributor to the big data is social media platform such as Facebook (Facebook.com 2018), Snapchat (Snapchat Application, 2018) and Instagram (Instagram.com 2018).

According to recent studies and surveys around 527,760 images are shared on Snapchat every minute of the day, which is an image sharing platform service popular nowadays. More than 120 people register every minute on LinkedIn, people watch over 4 M YouTube videos every minute and post around 50 k images on Instagram, an online social media platform (Koetsier n.d.)

The above terms are enough to understand the big data term on a broad scale. But let us also see what other factors instead of volume actually define the Big Data that we are going to discuss in this chapter (Fig. 1) [2, 3].

Fig. 1 Five V's of big data



Big Data is defined using five V's [4]. They are:

- Velocity,
- Volume,
- Value,
- Variety,
- Veracity.

Let us discuss about them in detail below [5].

Velocity Velocity in big data refers to the speed at which the data is being generated. It also deals with the amount of data being processed and analysed at the same time. The emails, images, videos, animation graphics and music audio are increasing at lightning speed throughout the world, therefore, this term is everchanging as there can be no specific 'velocity' of the big data. As more and more people are being introduced to mobile and Internet technologies, the pace at which they combinedly create data over the network increases exponentially.

Initially, the services that offered analytics on big data used batch processing to handle requests. A batch would be delivered to the server to generate response and then a new batch would be formed. This was good only when the contributors to the big data bubble were not very big in number. This means when the response time was faster than the incoming data rate (Fig. 2).

Now, with increasing users the service providers have also organized themselves in a proper manner so that they can provide real-time analytics to the data being generated and stored on the platform. They use big data technologies that employ various standardized databases and API techniques that ensure that not only the

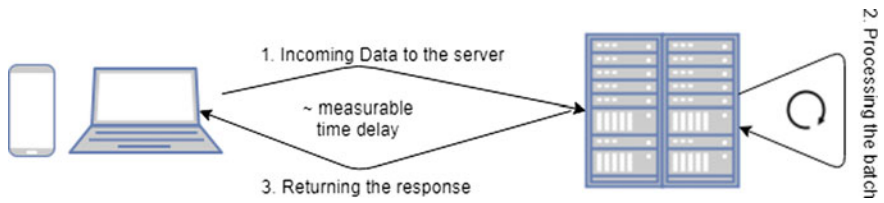

Fig. 2 Delayed processing

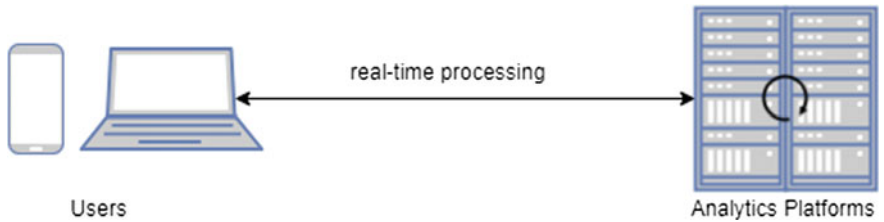

Fig. 3 Real-time processing and serving results

processing time taken for transmitting the data, from the user and back to the user is also minimum. Technologies such as Hadoop and NoSQL Databases are allowing platforms the freedom to exercise their analytics without worrying much about the time taken in storing and transmission of the same (Fig. 3).

Volume Volume is defined as the amount of space that a substance occupies or takes. Volume in big data is a term associated with the enormous amount of data that the machinery sensors, our mobile phones or even the simplest of reactions to any social media post contribute to this overflowing bubble of big data.

The size of consumable data is increasing day by day, for example a simple text file can range from bytes to a few kilo bytes, an image captured from a smartphone can be in a range of 2–8 MB or more, an audio file containing a song is somewhere around the same size and a movie video can be in gigabytes. There are several games that surpass the 50 GB mark as well. This shows that the current rate of data transfer and data storage on cloud is very high. This enormous data is contributing to the entropy of the big data bubble (Fig. 4).

This addition to the voluminous data is not just by active participants in the network but also by cars, credit cards, M2 M sensors, CCTV cameras and a lot more. Currently, any IOT device, i.e. network of physical objects that feature an IP address, is one of the biggest contributors to the big data. The data they produce is raw and unstructured but hold a great **value** in the data market.

Collecting and analysing this immense data is a technically difficult task, but there are certain technologies that allow us to manage them efficiently. We will discuss about them later in this chapter.

Value Value in terms of big data is not the worth of the raw data being stored on a platform. It is the measure of the influential data that can be generated after

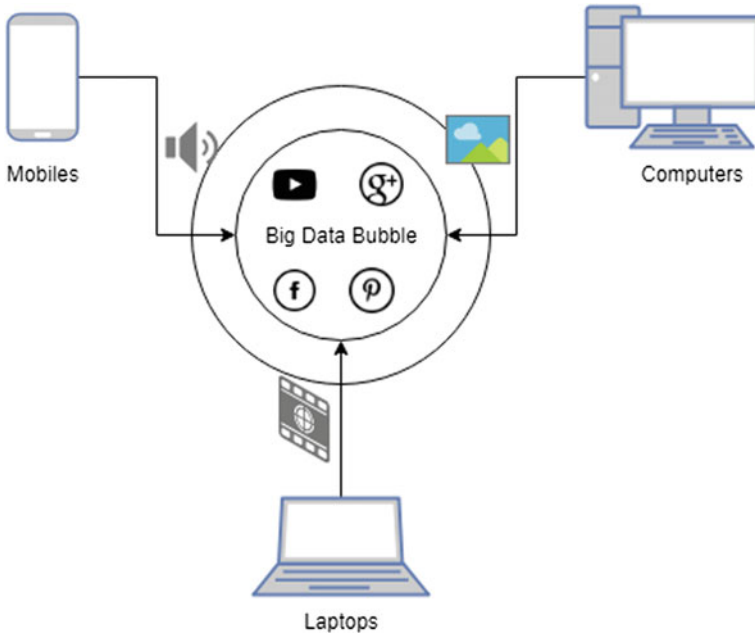

Fig. 4 Adding data to the big data bubble

processing the unstructured or raw incoming data. It is a measure of the usefulness of the processed data. While we can safely say that there is a direct link between the data and the insights of it but we cannot undermine the statement that more the data cannot always guarantee better insights, i.e. having more data does not mean having a better understanding of it. One of the most important aspects of data analysis is to understand and calculate the cost of storing, processing and analysing this data beforehand so that it does not incur any loss.

Therefore, the value associated with the data can be defined as the worth of data after *collecting, processing and analysing* and *reaping monetary benefits* out of it.

Variety Variety, as the name suggests, means that the incoming data being stored on the servers is not just in a single form. It need not be textual data. With the current age of modern technology and increasing numbers of media formats, we can safely assume that the big data, today, comprises mostly of multimedia data. This data can be in the form of text, audio, video, animation graphics or other formats of media storage.

Data comes in all types and formats such as structured data like numerical data in databases to unstructured data such as audio, financial market stats and more. We employ different strategies and technological hardware/software to ensure proper management of such data.

Veracity Veracity means ‘*conformity to the facts*’ or ‘*accuracy*’ of the facts. In big data terms, Veracity relates to biases, abnormalities and the noises in the data. It associates with the adulterated material in the big data scenario. Basically, ‘is the data being stored and analysed useful to the problem being discussed?’ is what veracity deals with. It is considered a bigger problem in data when compared to the volume or value of the stored big data.

We as analysts can try to reduce the noise as much as possible but certainly cannot reduce it to a complete zero. Data processing before analysing is a way to ensure that less amount of noise is being carried into the analysing platform and there are specific tools to identify the outliers for a specific problem so that we can have a better data to analyse.

Big data deals with issues beyond just volume and value, they are as above-mentioned veracity, variety and velocity. There is yet another V, called *volatility*, it refers to how long data is valid and must be stored before it is rendered useless for any analysing.

1.2 Big Data Analytics

So far, we have discussed a lot about analysing data in the above section. Here, we will discuss briefly about what data analytics is and what is its application. Analysis, in general, is a process of breaking complex things into smaller and simpler things to make a better understanding of it [6].

Use of advanced techniques such as application of complex models with elements such as predictive models, what-if analysis of data as well as applying statistical algorithms to raw data to perform analytical insights on it is what drives big data analytics. Big data analytics has given birth to various jobs such as data analysts and data scientist who analyse the ever-increasing volume of unstructured as well as structured data to ensure the growth of their respective companies or platforms.

In the next portion, we shall discuss about the applications that Big Data has in Multimedia Analysis.

Applications of Big Data in Multimedia Analytics

Big Data techniques have been employed to store and manage the multimedia data in the industry for a good while now. This allows a sensible way to collect and store data as well as a cost-effective option to analyse and give out results. Given below are a few applications of big data in multimedia analysis.

- Social Networks

Social Networks can be considered as the paradise of Big Data. Modern day social media consists of all types of data ranging from simple text to complex animations. Social Network is a wide area of research as it houses the biggest data collection on the planet. There has been a tremendous amount of publications as well as development in the field of social media big data analysis.

Analysing human social behaviour and activities based on the Twitter Feed (Twitter.com 2018) is one of the most famous projects. The ease of availability of huge amount of hashtag and tweet data of the user allows the creation of such enormous dataset. Twitter sentiment analysis is another hot topic that data scientists are working on. Using the twitter trending to analyse the tone of a tweet. It is also known as opinion mining as it is a computational process of determining whether a particular writing is positive, negative or neutral. Another such research was conducted on Facebook's data (Facebook.com 2018) since it is considered a more valuable data source.

Another use of multimedia analytics in big data field is the emerging research field of social recommender system. Such systems can range anywhere from an online e-commerce 'What users also bought' to a video streaming platform's 'Recommended for you' section. They incorporate social data into a recommender system to get the desired outputs for a user.

- Surveillance Videos

CCTV cameras or the surveillance cameras are the biggest sources of unstructured multimedia data. They are a constant source of streaming video data that can be put to great use using the advanced analytical solutions currently available in the world. The data captured using the surveillance cameras are considered of very high value. With the upcoming big data trends and technologies, a major breakthrough can be seen in the video feed research. Object identification is one of the primary goals of video research in any surveillance camera feed. It allows us to monitor sudden and certain changes in a video by applying methodologies such as convolutional neural networks to identify objects in a live video feed.

In the US, one such project was identifying the cars number plates via the camera feeds on the traffic signals. This helped to identify and locate a lot of stolen cars and even improved the traffic laws being followed all throughout the states.

- Smart Phones

In the recent years, mobile phones particularly smart mobile phones or smartphones, in general, have taken over the electronic world. The user base of smartphone has taken over the entire userbase of laptops and PCs combined. Billions of individuals carry smartphones inside their pockets almost anywhere and everywhere. A single smartphone is equipped with technologies such as powerful CPUs, intense graphics engine, multimedia capabilities, Bluetooth, Wi-Fi and all sorts of network connection capabilities. Alongside that, the flooding of applications for smart devices has also made them a root cause of the production of vast multimedia data.

With many sorts of functionalities that a smartphone possesses there are vulnerabilities that must also be taken into account such as network security vulnerabilities that may cause the user's data into unwanted hands. We shall discuss about security later in this chapter.

- Other Areas

If we look beyond the scope of what has been discussed as the application of big data analysis in multimedia data there are several places where big data analysis is used. Multimedia summarization, Internet of Things, disaster management systems and healthcare are a few industries to name. There can be a variety of data such as records, patient's history, genomic records and a lot more that needs to be stored and analysed. Biomedicine is a growing field that has been benefited by the use of big data analytics.

2 Sharing Multimedia

The user's perspective of multimedia data has always been sharing it. Sharing is a primary goal of creating the multimedia data. Any sorts of multimedia are a replacement for text messages, because they can be used to express various things and not just words, they can express joy, sadness and other expressions in a single frame of a picture or multiple frames of a video.

In this section, we shall study about how data is shared between devices. Though the topics are more networking based, but a brief introduction to the required subtopics has been provided.

2.1 *Sharing Multimedia Over a Wired Network*

This is one of the primitive ways in which data has been shared across devices. Although this is not a very old method of sharing data, there exist better methods to facilitate media sharing among devices in a network. We will discuss about the topologies that allow the formation of a network.

Wired network is an interconnection of devices that are connected to a common network through a communication medium which is wire. Two devices may be connected in some way to the same link at the same time so that communication can occur. There are two types of connections: **point-to-point (P2P)** and **multipoint**.

Figure 5 shows the involvement of a sender, a receiver, a message that contains the data that needs to be transmitted or shared, the medium is the wired connection, and some protocols governing the information exchange between the sender and receiver. The process is the same for any kind of data since the packets follow a strict protocol for being delivered.

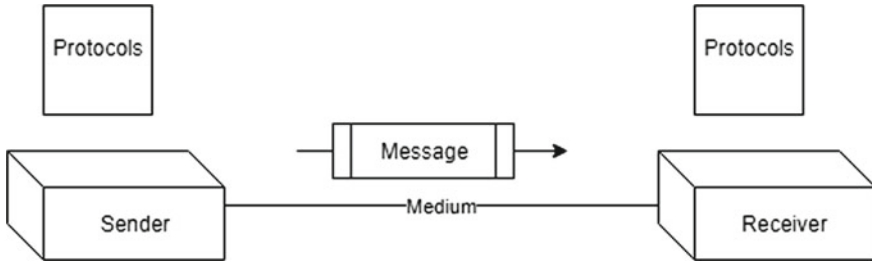

Fig. 5 Components of data communication

The interconnection of devices in a network is called as topology. Topology is the way in which the devices are arranged in a network connection. The way in which the network is laid out physically is defined by the topology of the network. It is a geometric representation of the links that are formed between the devices, sometimes also called as **nodes** of the network. There are four basic topologies: mesh, star, bus and ring.

There are other ways in which the nodes can be arranged in a network to create a physical layout which may be a combination of two or more of the four discussed topologies. These topologies are called **hybrid topologies**.

2.2 Multimedia Sharing OTA (Wirelessly)

Mobile phones and laptops today come equipped with the latest technologies that allow not only sharing of data through wired medium but also sharing data via wireless mediums, for example, Bluetooth, Infrared and Wi-Fi networks [7].

In this section, we shall have a brief overview about what these technologies are and how does data transfer happen in them.

2.2.1 IEEE 802.11

IEEE has defined the specifications for a wireless LAN called the WLAN or the IEEE 802.11. It defines a Basic Service Set (BSS) as the building block which may or may not be controlled by a central base station also known as the access point. A BSS without an AP is an ad hoc network whereas a BSS with AP is an infrastructure network (Fig. 6).

Data transmission in a wireless network works in the same way as it works in the wired networks. The information to be transmitted is broken down into pieces called as **packets**. These packets then run through the entire network and are transmitted from the sender to the receiver. Since there are no direct physical connections between the devices and the delivery of packets must be done in order to make sure that the data

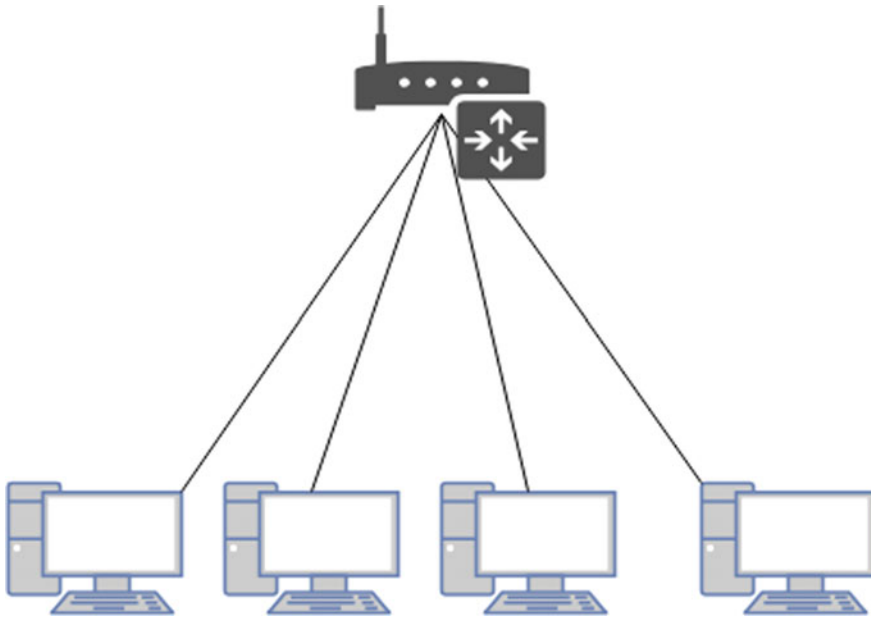

Fig. 6 Nodes connected to a wireless router *Note: the connections are not done using wires*

Table 1 Implementations of IEEE 802.11

FHSS	Frequency Hopping Spread Spectrum
DSSS	Direct Sequence Spread Spectrum
Infrared	Using Infrared for Transmission

is being transmitted throughout the network and any corrupt frame is retransmitted. The noisy wireless environment requires fragmentation—dividing the bigger data frames into smaller ones. It is more efficient to resend a small frame than to retransmit a large one in the entire network.

The main implementations of IEEE 802.11 WLAN are: (Table 1).

The wireless LAN technology allows the devices to share data, files, audio and a lot more on a common network without even being physically connected to the other node. The initial cost of setting up a wireless router may be high but the overall cost of maintaining the network is very less when compared to the wired network. Wireless networks also pose another advantage over the traditional wired networks that is the ease of removal and addition of a new node to the network. Previously, a new node could only be added once the central router has a free slot and a link was needed in order to connect the node to the network. This additional link added to the cost of maintaining the network. But with wireless LAN, a network is created which does not require any physical connection such as a wire. Therefore, adding a new node or removing one from the network is very easy.

2.2.2 Bluetooth

Bluetooth is also a wireless LAN technology designed to connect devices of different types together. The devices connected to a Bluetooth network can range from a mobile phone, headphone, notebooks, cameras and even printers. There are a lot of devices that are *Bluetooth Enabled*. A Bluetooth network is an ad hoc network which means that the network is formed spontaneously. The Bluetooth network can be connected to the internet if any one of the devices on the network has the access to the internet.

Applications of Bluetooth

- Connecting peripheral Bluetooth device such as wireless mouse and keyboard to communicate with the computer.
- Streaming music audio directly to the Bluetooth headset device. Bluetooth streaming of audio plays an important role in hassle-free media streaming.
- Manipulating hidden computing paradigm to make automatic synchronizations which helps in devices which carry out tasks without the user's intervention.
- Multimedia transfer is another usage of Bluetooth. Users can exchange multimedia data such as texts, images, videos and other animations using Bluetooth networks.
- Bluetooth is used by Home security devices to connect to sensors to gather data from them wirelessly.

Bluetooth, today, is an implementation of a protocol defined by the IEEE 802.15 standard. The standard defines a wireless **PAN (Personal Area Network)** which can operate in an area as small as room or maybe a hall.

Bluetooth has two network types, viz. *Piconet* and *Scatternet*.

A **piconet** is a small Bluetooth network which can have up to eight stations, one of which must be a primary station and the others will be secondary stations. There also exists a *parked state*, in which the node is in sync with the primary of the net but cannot take part in any communication or data transfer in the network.

A **scatternet** is a combination of more than one piconets in which a secondary of a piconet is the primary of other piconets (Fig. 7).

Bluetooth devices have a short-range radio transmitter. The current data rate is 1 Mbps with a 2.4 GHz bandwidth.

Layers of Bluetooth

Bluetooth protocol stack consists of 5-layer (Table 2).

2.3 Continuous Media Sharing

Continuous media sharing is a relatively new methodology that is used in streaming the content of a multimedia over the network in real time. Streaming music or video online on a service such as Spotify (Spotify.COM) or YouTube (Youtube.COM).

Media streaming solutions like these have become a solution to share data to the people in real time. One of the most popular usages of CMS is Internet Television,

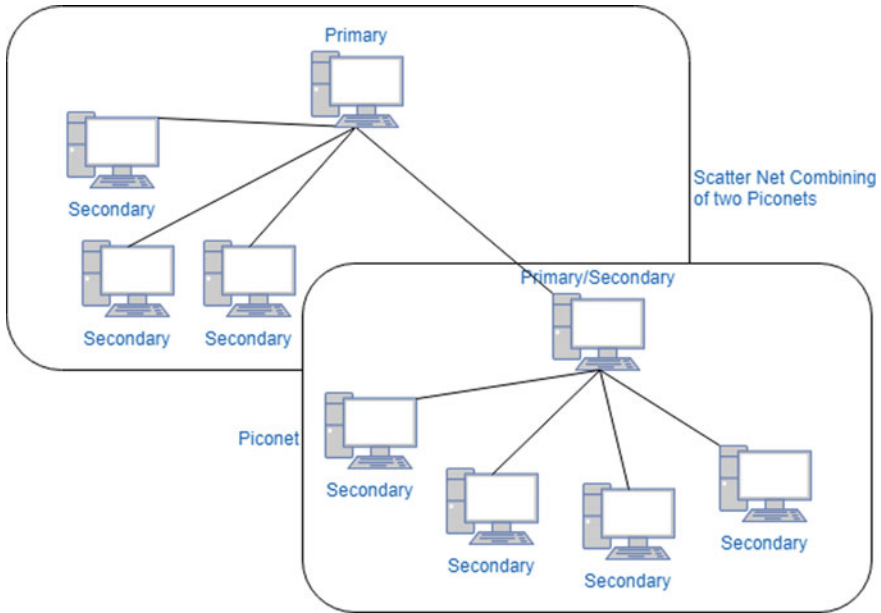

Fig. 7 Scatter-net and Piconet

Table 2 Layers of Bluetooth

Radio	This layer specifies the requirement for radio transmission
Baseband layer	This can be considered similar to the MAC sublayer in LANs
LMP	Link Manager Protocol defines the procedure for link set up and link management
L2CAP	Logic Link Control and Adaption Protocol is responsible for adapting the upper layer protocols to the baseband layer
SDP	Service Discovery Protocol allows querying of available devices for a Bluetooth connection

providers such as Hotstar (HotStar.COM) use this service to broadcast television network over the internet to its registered users.

There are several ways in which a media can be streamed over the network.

- Serving the file over the Web.
- Using a Media Server.
- Real-Time Streaming Protocol (RTSP).

Fig. 8 VoIP video calling

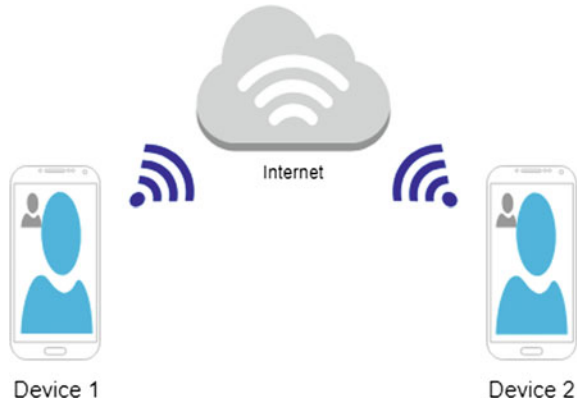

Streaming live audio and media is similar to that in case of a radio or TV, but the broadcasting is done over the internet and not the cable networks.

Real-time Transport Protocol (RTP) and RTSP are designed to handle real-time traffic on the internet and adding more functionalities to the streaming process.

VoIP: Voice Over IP is one such interactive audio/video application of multimedia sharing. This application allows communication over the internet to facilitate communication between two parties. Voice and Video calling support in popular chat applications such as WhatsApp and Facebook work on this principle (Fig. 8).

2.4 Mobile Networks and Cloud Sharing

All electronic devices are capable of storing data on themselves. It can be stored in the device’s memory, often called as the internal memory or an extended service memory can be added to the device to extend the storage capacity, often a secondary memory like a MicroSD Card in a mobile phone can be used.

Now a days, people are shifting to a more cloud-based lifestyle. But What exactly is a cloud? Cloud, in simple terms is an extended memory for your device. Any device has internet connectivity can access cloud services (Fig. 9).

Data storage in cloud is done in physical or virtual servers. These servers are controlled by a Cloud Computing Provider (CCP). CCP(s) provide physical storage for use. Storage is done on physical devices in server farms. A registered user can take certain amount of storage space from the cloud for a set of pricing and use it for storing and sharing the data. Cloud services can be free up to a certain amount of storage and then charge for more or in some cases can only be used after paying a certain amount of money [8].

With internet connectivity provided by the mobile carriers, it is fairly easy to connect and use the cloud service.

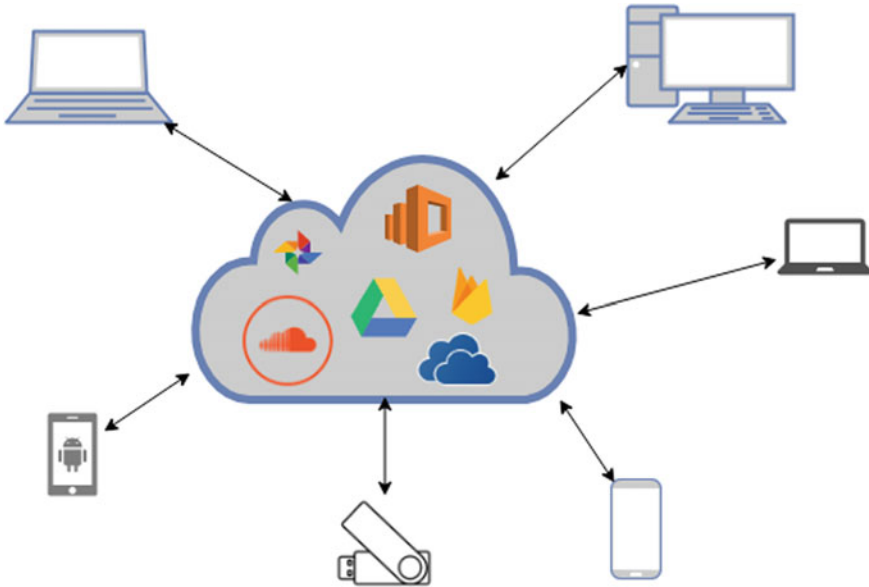

Fig. 9 Cloud services allowing seamless data transfer among all devices

Benefits of Cloud Services [8, 9]

Data storage on Cloud. Cloud platforms provide the user with accessible storage units via the internet. These storage units service serve the purpose of storing the data online. By storing all the files and folders online, we are provided with the ease of accessibility of the file anywhere and anytime. Any electronic device can be used to access the cloud storage as long as it is connected to the internet. Using cloud solutions for managing the data enhances the productivity, operations and the efficiency of the business solution.

Easy File Transfers. Seamless data transfer to and from the cloud server is another intimidating feature. There are services that provide only one type of files to be stored, but mostly clouds allow heterogenous data to be stored and modified. Typically accepted files on a cloud can range from PDFs to Docs, pictures and motion videos to spreadsheets and music files. Multiple compression algorithms along with security mechanisms are used to ensure data safety as well as faster downloads and uploads.

Backup Files on Cloud. The most common functionality of the cloud is to backup files. Services such as Google Drive or Google Photos are constantly used to create an automatic backup of your files and media to ensure data safety in case the device is no longer available with the user. Automatic backups ensure timely updates of all files on the device.

Sharing Media and Data. Cloud platforms provide with different level *views*, these views allow certain restrictions on the intractability of the user. For example, uploads

can be restricted to the owner of the cloud but the files on the cloud of a user can be made available to the world for download purpose. Google Photos create a link that allows others to browse through your album without (sometimes with) the authority to add/delete media to/from it. Sharing data has been made easier with the cloud storage solutions such as OneDrive, Google Drive and Amazon Servers.

3 Storing and Saving Multimedia Data

Multimedia data is accompanied by a lot of **metadata**. Metadata is what defines the data. It is the data about the data generated or stored. Media data consists of a lot more than just the media, therefore, it requires more space than the media itself. Storing and serving a huge quantity of data is not easily possible and hence, provisions such as cloud storage for sharing and saving media data and other has been developed [10].

In this section, a discussion on services that offer multimedia storage has been done. Social media and its applications along with the impact that the cloud has to offer on the social media. We will also do a brief discussion on the security threats posed on the multimedia data.

3.1 Services for Multimedia Storage

Multimedia storage is provided by a variety of cloud platforms. These storages support heterogenous data to be uploaded to the *drive* (*space allotted to the user is often called as a drive*). There are a lot of cloud providers, for this section we are going to compare the three biggest user-centric cloud services providers viz. Google Drive, Dropbox and OneDrive.

Dropbox

Dropbox is an online storage service. Dropbox is the oldest available cloud service among the three proprietary services that we are going to discuss in this chapter. It was launched to the public in 2007. It is a heterogenous cloud storage platform capable of seamlessly storing all kinds of media and data. It allows for storing of any files, sharing of the media with friends and family and an additional plus of automatically syncing local data. Although the basic services are free for Dropbox users there exists a pro version that allows for extended storage options as well. Dropbox can be availed by the regular user on all platforms like iOS, Android as well as Linux, Blackberry, etc.

Google Drive

In 2012, Google launched its cloud storage service called the Google Drive and hence the term *drive* was made analogous to cloud storage for general purpose users. Google

Drive made a mark after it hit the smartphones with special apps for Android, iOS Devices, etc. It operates freely with a Google account but services for more storage options can always be purchased for a varying fee. It is also a heterogenous media storage option with access to Google Drive office suite. It is available on potentially all platforms across the globe.

OneDrive

OneDrive was initially launched as SkyDrive before being acquired by Microsoft and renamed to OneDrive and was opened to public in the year 2014. It is Microsoft's contender to the world of cloud storage. It is, again, a heterogenous storage service that allows all popular files to be stored on the servers. The service comes integrated with Microsoft's popular operating system Windows 8 and Windows 10. It has cross-platform applications for users using other operating systems (Table 3).

Some popular homogenous data storage services include:

Google Photos. Allows storing of Photos on the Cloud.

Flickr. Another Photo Storage Service.

Dailymotion. Video storage and sharing platform.

YouTube. Most popular public video storing and sharing platform.

3.2 Social Media and Data Sharing

Social media is a platform to connect with people. The sharing of data is not limited to text but also has images, videos and voice notes. There are various applications that are ruling the social media industry and account for the maximum media sharing across any platform.

3.2.1 Emergence of Facebook and Twitter

Facebook and Twitter are the biggest names on the planet in terms of social media outage. Facebook, till date, remains the biggest social network to ever exist across the globe with a monthly usage by about 2.27 billion users. Users are allowed to share their expressions in the form of text, images and videos. Facebook and Twitter have become popular media sharing platforms used by masses to drive the world. Twitter has approximately 336 million monthly users and is more popular among movie stars and athletes as it allows a 'follow-based' system to get notified of the updates instead of the 'friend-based' system followed by Facebook.

Facebook and Twitter currently account as one of the biggest producers of multi-media data. They make sharing media easy for people. Once connected to the fellow users a user can simply 'post on the wall' or 'tweet' a sentiment, which may contain a textual data, an image or video corresponding to any topic, some graphic content and even audio files.

Table 3 Comparison of cloud providers

Feature	Google drive	Dropbox	One drive
Ownership	Google LLC (Google.com)	Dropbox, Inc (Drobbox.com)	Microsoft (Microsoft.com)
Release	24 April 2012	June 2007	February 2014 (Following a Lawsuit)
Industry type	Cloud storage, Client software, file sharing	Online cloud, file sharing	Cloud, File share
Written in language(s)	Python, Objective-C (Mac client), wxPython (Windows)	Python, Go, Typescript	C, C++ and Python
License	Freeware	Combined with GPLv2 and proprietary software	–
Allowed free usage	15 GBs	2 GBs	5 GBs
Storage options	100 GB, 1 TB, ranging up to 30 TB	1 TB and more	50 GB, 1 TB, 5 TB
Cross-platform clients	Available on all devices like Android, Linux, Windows, iOS and more	Has applications developed for all platforms like Android, iOS, Blackberry and more along with desktop platforms	Available on all major operating systems and mobile OS(s)
Extended abilities	Yes	Yes	Yes
Abilities/Software	Google Docs, available for free to use, is an online office solution	Dropbox has Dropbox Paper, a collaborative text editor for special users	Office 365 suite
Number of users (approx.)	1 billion users	Greater than half a million	Quarter of a million users

Companies and business have been using the power of social media to improve their growth by ensuring proper content sharing across the network using dedicated Social Media teams. Twitter and Facebook have made it easier to connect to the people across the globe and hence sharing of content on a platform like this give it an edge above everything. Although both are considered equally good, but studies have shown that Facebook *posts* are 6 times more effective and have a bigger outreach than Twitter *tweet*.

3.2.2 Image Sharing Platforms

While social media applications have a predominant upper hand on the media sharing but after the development of dedicated media sharing applications and platforms, there has been a gradual decline in the growth of amount of data produced and shared across the two popular social network sites. Applications and platforms such as Snapchat, Instagram, Google Photos and Flickr have added to the Image sharing entropy.

Instagram. It is a photo and video sharing service owned by Facebook. Service allows the registered users to post images with various *captions* and *filters* to further enhance the image. It has become one of the popular choices of users to share media, specifically visible media like images and videos. Instagram has a bigger outreach to offer since most of its users are Facebook users and are quite familiar with the service. It is available for users as a cross-platform application.

Snapchat. Snapchat is a multimedia messaging application developed by Snap Inc. Snapchat provides the user with a completely new feature for data sharing. The pictures and messages shared across the platform were visible only for a certain amount of time and could not be retained initially and became inaccessible to the user. It has since then evolved and introduced yet another important sharing feature of *stories* of 24 h of chronological content. It is a mobile-first application and near about 200 million registered users.

Google Photos. While the previous two applications can be considered as a social media for image/video sharing, Google Photos is an online storage unit that allows the user to upload, download and share the clicked images and videos (only) with the people of their choice. It 'generates link' for the selected items to be shared. The visibility of the items in the album can be controlled by the original author and can also give special permission to add more content to the album etc.

Flickr. Flickr is an image and video hosting service acquired by Yahoo!. Developed in 2005 it has been a source of hosting images and videos for the phot researchers and bloggers across the globe.

There are other important platforms that provide media sharing capabilities like Pinterest, DeviantArt and Imgur that allow free image hosting and sharing capabilities.

3.3 Cloud and Its Impact

We have discussed various services that offer cloud services. Let us have an overview of the impact that the cloud has on users and businesses [11].

Accessibility and Usability. With the easy options of seamless transfer of files to the cloud simply by dragging and dropping files and folders, cloud provides ease of

use. Saving files on a cloud is as easy as saving them on the local machine and hence requires little to no technical knowledge.

Disaster Recovery. Cloud acts as a secure backup plan for business in case of an emergency. Backup is one of the most important uses that cloud storage is put to. Users can save their work, images, videos and be carefree about losing them. Snapshots and automated backups allow easy data recovery in the cloud.

Security. Since the data on cloud is distributed across different servers hence allows for better security of the data. Using redundant data servers along with snapshot mechanism for automating backups helps in improving security.

Cost Saving. Cloud is an extended storage for users as well as businesses. There is not need to be bothered about managing huge server farms for storing data performing computation on a large scale. Cloud providers provide storage units at different costs which is very less than managing the entire storage physically.

Easy Sharing. Cloud allows the user to share a similar environment together. The author of the original data can give permissions to the others to view, modify and delete the contents of the drive. Hence providing an easy-to-share interface.

Automation. Servers that store the data on cloud are configured with continuous integration or CI. CI helps in automating tasks that could be performed on the drive for different hooks. A hook is an action performed on the drive's data. In addition to it, we have periodic backups as well.

Collaboration. Online cloud acts as a platform for the shared learning experience. It is a collaboration platform where multiple people can access, edit, modify and collaborate on a single file. Any user with internet connectivity and access to the cloud data can collaborate with the original author.

Scalable Service. Service providers create plans on 'pay what you use' basis. Cloud, henceforth, is scalable in nature. The dimensionality of the environment can be changed as and when required by simply choosing a different plan or different set of configurations for the drive.

Convenience. Cloud provides an enriching experiencing of getting your files and folders wherever you want. The data stored on servers does not require any manual interventions as no physical device needs to be carried in order to procure the data. The seamless transfer of data from cloud to the device and vice versa makes it really convenient.

Synchronization. Data on the local machine is either automatically synchronized or done manually in order to update files on the cloud. It removes the stress of manually transferring the data after every update to the file or data.

Cloud provides more than just storage units, there are deployment containers that allow easy and scalable deployment environments for the builds [12]. One such free service is Heroku. There exist computationally extensive containers provided by providers such as Microsoft Azure and Amazon AWS. Google Cloud also offers computationally extensive cloud experience embedded with their own Tensorflow engines for heavy machine and deep learning.

3.4 *Multimedia Data and Security*

Although cloud services provide with numerous benefits, but the business enterprises still do not use the cloud for big data. It may be because of lack of visibility and not enough trust in this new infrastructure. Mobile security is another threat to multimedia big data. With the rapid escalation in the number of mobile devices, data privacy and security have been a major concern. Privacy control on different levels must be provided to ensure maximum safety of the data. Security mechanisms may include security storage and management, multi-granularity access control and privacy-aware data mining and analysis.

A multimedia platform, or a cloud platform must find the appropriate balance between access control and processing convenience. Furthermore, proper methods for encrypting multimedia data must also be employed in order to ensure data safety.

4 *Analysing MMBD*

4.1 *Data Transformations*

Data store contains the data that has been accepted for the next analysis. OLAP technology can then be used for performing this analysis. Analysis is done using data mining techniques or by the help of reporting services. This process requires a great amount of skill and expertise. It is an important step in the analysis of content and technologically heterogeneous data sources so that relevant data can be chosen. Aggregation, integration, collection and centralization of data takes place afterwards. Data pumps serve to collection and transmission of data from source systems to data stores and dumping ground. They include:

- Extraction, transmission and transformation of the data (ETL).
- Applications integration systems (EIL).

4.2 *Database Components*

The concept of data warehousing was coined in 1991 by Bill Inmon. Data warehouses were established as an independent information system set above business data. Data market is problem oriented, whereas, data warehouse is subject oriented. New multidimensional database models were introduced for the purpose of storing data which allowed easy and quick creation of views on data. This technology is the bases of today analytical tools of Business Intelligence (BI). Corporate Performance Management (CPM), is a new type of business planning created by the integration of BI with business planning. Data warehouses are special types of business databases

which contain consolidated data from all accessible service systems. Their optimization is done for quick administration of analytical information and not for quick data processing or quick transaction since the main aim is to mine data from the sources. They ensure processes of storing, actualization and administration of data. There exists two basic types of data stores:

Data Warehouse

Data warehouse is a wide centralized database for business application wherein data from all sources and external databases are saved.

Data Marts

Data marts are different from data warehouses as they are decentralized and thematic oriented. The analytical information that they provide is centric to one section or one specific group of people.

There exist two types of Auxiliary data stores:

Operational Data Store (ODS).

Data Staging Areas (DSA).

4.3 Analytical Components

OLAP [13, 14]

Data in data warehouse is cleaned out and integrated but it is often very voluminous and hence maintaining is not easy. OLAP (Online Analytical Processing) is a special technology used for this purpose and it employs special data structures for the same. OLAP tools are simple, readily available and very popular as well as susceptible to create multidimensional analysis.

The OLAP technology is employed on multidimensional data. The data is stored in an n-dimensional cube. The database so formed is not in normalized state. A schema is formed by the tables and facts. A different visual angle is provided by every dimension on the data. Data can therefore be organized logically as well as hierarchically.

Knowledge Mining from Data [15]

Objective setting

It begins with a problem statement which can be related to the real world and hence begins the data mining process. The end of the process is marked by enough amount of extracted information to solve the problem statement [16]. These properties of data mining make marketing an apt area of its use.

Data selection

Data for data mining must be chosen carefully. In normal circumstances, data is usually extracted from source systems to a special server.

Data preprocessing

Preparing data for analytical processing is an exacting process. It is necessary to choose corresponding information from the voluminous databases and save it to a simple relational database. Data preprocessing consist of next steps:

- Clearing Data—solving the inconsistent data or missing data problem.
- Integrating Data—multiple sources can often lead to redundant data in the server, which must be resolved.
- Data transformation—formatting of data.
- Data reduction—normalizing the data in the database as well as the formation of data models.
- Analysis and exploration of data—independent data searching without previous knowledge.
- Description—describing the complete data set.
- Prediction—Prediction phase is used to calculate the values for unknown input.

Data mining methods include

- Regression methods—linear, non-linear regressions, neural networks, etc.
- Classification of data—decision trees, SVM etc.
- Data segmentation—clustering analysis, genetic algorithms, neural clustering
- Time series prediction—Box–Jenkins method, neural networks
- Deviation detection

4.4 Tools for End Users [17]

Analytical Tool—Microsoft SQL Server 2008

Just after OLAP was introduced, Microsoft began implementing a model of self-service analytical tool. In the 2005 version of Microsoft SQL Server, all analytical levels were joined into a Unified Dimension Model. MS SQL Server 2008 is the focal point in Analysis Services which are containing OLAP, Data Mining, Reporting Services and Integration Services. With the addition of SQL Server Integration Services (SSIS) it worked as an ETL data pump. It provided benefits such as allowance of creation of data administration applications. Manipulation with files in directories, data import and data export were another set of features. Reporting Services such as SQL Server Reporting Services (SSRS) provides a flexible platform for creating and distributing reports. MS SQL Server report builder is a free tool, that is usable for reports creation. SQL Server Analysis Services (SSAS) is a key analytical service for data analysis. It consists of two components:

OLAP module for multidimensional data analysis enabling loading, questioning and administration of data cubes created by Business Intelligence Development Studio (BIDS) [18].

Data Mining module which extended possibilities of business analyses.

Data Analysis User Tools—MS Excel

Microsoft Excel is the easiest and the most obtainable of business data analytics tool. Every manager or chief executive has this software installed onto the desktop of his/her office desk. The ease and simplicity of MS Excel allow users to create reports without any external software. Graphs and reports along with other mathematical representation of data can be easily produced using MS Excel. Microsoft Excel provides a dynamic and effective range of data analysis. It offers a dynamic set of views and graphical views for the data. The most common way of inserting data to MS Excel is the manual table filling from business reports. The second way is easier and fast. It deals with importing data directly from the BIS, Business Information System. Another possible way is directly connecting the BIS to the databases. This way is most operative. MS Excel provides a set of different analysis done using pivot tables and graph pivot table. They are considered to be the most important tools of Excel. Excel enables data summarization, filtration and ordering. It is possible to create a lot of different views, reports and graphs from one data source. Creation of pivot table is easy—we can add or delete data, columns, rows or change summaries without influencing the data of other data sources. Pivot tables are very often used as a user tool for working with data cube used by SQL Server.

5 Conclusion

In this chapter, we discussed the field of Multimedia Big Data sharing on Data analytics platform. Multimedia data is a major contributor to the big data bubble. It is produced so that it can be shared among family, friends and even masses. Sharing of media data can be done in various ways and all of them have been covered in this chapter. Further, the chapter covered cloud services as a recently developed area for storage and computation. Impacts of social media giants like Facebook and Twitter along with Google Drive have been discussed. The chapter ends with a brief mention of security of online data and analysing the MMBD. Tools for user end analysis of data have also been given a brief mention in this chapter.

References

1. E. Adler, Social media engagement: the surprising facts about how much time people spend on the major social networks (2016). Retrieved from <http://www.businessinsider.com/social-media-engagement-statistics-2013-12>
2. A. Labrinidis, H.V. Jagadish, Challenges and opportunities with big data. *Proc. VLDB Endow.* **5**(12), 2032–2033 (2012)
3. K. Michael, K.W. Miller, Big data: new opportunities and new challenges [guest editors' introduction]. *Computer* **46**(6), 22–24 (2013)
4. S.B. Siewert, Big data in the cloud - Data velocity, volume, variety and veracity (2013). <https://www.ibm.com/developerworks/library/bd-bigdatacloud/index.html>

5. C.L. Philip Chen, C.-Y. Zhang, Data-intensive applications, challenges, techniques and technologies: a survey on big data. *Inf. Sci.* **275**(2014), 314–347 (2014)
6. P. Tan, M. Steinbach, V. Kumar, *Introduction to Data Mining* (2005). ISBN 0-321-32136-7
7. J. Bergstrom, M. Drovdaahl, S. Temple, Wireless data capture and sharing system, such as image capture and sharing of digital camera images via a wireless cellular network and related tagging of images. US Patent App. 12/182,952 (2008)
8. M.D. Assunção, R.N. Calheiros, S. Bianchi, M.A. Netto, R. Buyya, Big data computing and clouds: trends and future directions. *J. Parallel Distrib. Comput.* **79**(2015), 3–15 (2015)
9. S. Dey, A. Chakraborty, S. Naskar, P. Misra, Smart city surveillance: leveraging benefits of cloud data stores, in *Proceedings of the IEEE 37th Conference on Local Computer Networks Workshops* (IEEE, 2012), pp. 868–876
10. S. Pouyanfar, Y. Yang, S. Chen, *Multimedia Big Data Analytics: A Survey*, Florida International University (2018)
11. G. Shmueli, N. R. Patel, P. C. Bruce, *Data Mining for Business Intelligence* (2006). ISBN 0-470-08485-5
12. S. Sakr, A. Liu, D.M. Batista, M. Alomari, A survey of large scale data management approaches in cloud environments. *Commun. Surv. Tutor.* **13**(3), 311–336 (2011)
13. D. Pokorná, *Business Data Analyses Possibilities*. Diploma thesis. Faculty of Applied Informatics, Tomas Bata University in Zlín (2010)
14. M. Berthold, D. Hand, *Intelligent Data Analysis* (Springer, Berlin, 2009)
15. S.C. Hoi, J. Wang, P. Zhao, R. Jin, Online feature selection for mining big data, in *Proceedings of the 1st International Workshop on Big Data, Streams and Heterogeneous Source Mining: Algorithms, Systems, Programming Models and Applications* (ACM, 2012), pp. 93–100
16. A. Bifet, Mining big data in real time. *Informatica (Slovenia)* **37**(1), 15–20 (2013)
17. P. Zdenka, S. Petr, S. Radek, *Data analysis: tools and methods*, Tomas Bata University in ZLín (2011)
18. H. P. Luhn, A business intelligence systems. *IBM J. Res. Dev* 314–319 (1958)

Legal/Regulatory Issues for MMBD in IoT



Prateek Pandey and Ratnesh Litoriya

Abstract Internet of Things (IoT) is a network of connected devices that collect and transmit data for further processing. The size and nature of the data generated by IoT devices determine processing, transmission, and regulations involved in the application. IoT applications that require Multimedia Big Data (MMBD) also pose some privacy and security issues. Legal frameworks to deal with IoT related issues are either nonexistent or nascent. Effective regulatory measures are required to set in place to deter the unlawful use of the colossal data that is generated through IoT devices from every walk of life, including but not limited to, smart homes, wearables, connected cars, health care, smart retail, and many more. The flow of data across the continents and countries rises accountability, security, and privacy concerns, because the country from which the data was collected and the country in which it is processed may have incompatible laws. This chapter details the fundamental issues related to the use of MMBD in IoT applications and also presents a systematic discussion of some emerging questions regarding the transfer and use of data across the internet.

Keywords MMBD · IoT · Cybersecurity · Regulations · Privacy · Issues

1 MMBD in IoT Applications at a Glance

Human beings are different from other living creatures because they have curiosity. Due to this curiosity humans questions a lot. We are the one who challenges day to day business out of existing human traits and tries to create something improved. This effort and curiosity guaranteed us an existence where electronic gadgets and machines will most likely turn into our closest companion. Indeed, the vision is to make machines adequately brilliant to diminish human work to near nil. The

P. Pandey · R. Litoriya (✉)

Jaypee University of Engineering and Technology, Guna 473226, MP, India
e-mail: litoriya.ratnesh@gmail.com

P. Pandey

e-mail: pandeyprat@yahoo.com

© Springer Nature Singapore Pte Ltd. 2020

S. Tanwar et al. (eds.), *Multimedia Big Data Computing for IoT Applications*, Intelligent Systems Reference Library 163,
https://doi.org/10.1007/978-981-13-8759-3_14

367

initiatives of connected machines/devices where the machines are smart enough to generate and share information with us, to cloud-based applications and each other are commonly called smart devices. Smart devices are designed so that they catch and use all of the information which you throw in your routine life. What's more, these smart devices will utilize this information to help you in accomplishing your tasks efficiently.

The world is waiting for the diffusion of internet-connected devices, also called the Internet of Things (IoT)—a network of networks—to provide value-added services [1] into our daily walks of life. Despite the fact that the universally accepted definition of IoT doesn't exist, but for common understanding, the IoT can easily be defined as a network of networks—where a vast number of embedded devices are connected all the way through the communication infrastructure to make value-added services available to different classes of users [2]. This is a setup wherein people, animals, or objects/devices are provided with inimitable identifiers and the capacity to transmit and receive data over internet/intranet without a need of human-to-human or human-to-computer interaction [3].

IoT is a rising technology of physical devices that are capable of connecting and to the other networks over the wireless Internet. IoT systems have different technologies such as: RIFD, NFC, 3G, 4G, and sensors [4] working over a connected array of devices such as smart cars, smartphones, wireless cameras, smart thermostats, smart refrigerators, smart baby monitors, wearable devices (such as Fitbit and smart watches), and implantable medical devices [5]. Development and analysis of the combination of fog computing, cloud computing, and IoT have widely carried out to provide uninterrupted context-aware healthcare services to the end users as and when required [6].

The IoT enables individuals and objects/things to be linked with anyone and anything, at anyplace and anytime, preferably utilizing any heterogeneous network and service [7]. These smart IoT devices are persistently transforming our homes, cities, education, transportation, healthcare technologies, energy infrastructure and many more domains of life [8]. These smart IoT devices when combined with software applications along with network connectivity, and cloud storage has built a new generation of embedded systems [9]. All these smart devices are seamlessly generating multimedia and Big data.

After some time, this innovation will be used in a large number of daily aims and to a great extent will also be imperceptible to customers. Unquestionably, IoT has entered into every aspect of our lives, and in reality, is gradually creeping into the regular day-today existence of many. Gartner points out the market for IoT devices is on edge to burst and will reach a figure of about 21 billion connected devices by 2020 [10], see Table 1.

For hardware spending, Business: Vertical-Specific applications will amount to \$667 billion in 2016, whereas the use of connected things in the consumer will drive \$1534 billion in 2020 [11] (Table 2).

The speed of acceptance of smart devices (IoT) and the technical and societal shifts it has produced remains unparalleled. These smart devices will cross over any barrier, be it digital or physical, enhance the quality and efficiency of life, society,

Table 1 Internet of things units installed base by category (Millions of Units)

Category	2014	2015	2016	2020
Consumer	2,277	3,023	4,024	13,509
Business: Cross-industry	632	815	1,092	4,408
Business: Vertical-specific	898	1,065	1,276	2,880
Grand total	3,807	4,902	6,392	20,797

Table 2 Internet of things endpoint spending by category (Billions of Dollars)

Category	2014	2015	2016	2020
Consumer	257	416	546	1,534
Business: Cross-industry	115	155	201	566
Business: Vertical-specific	567	612	667	911
Grand total	939	1,183	1,414	3,010

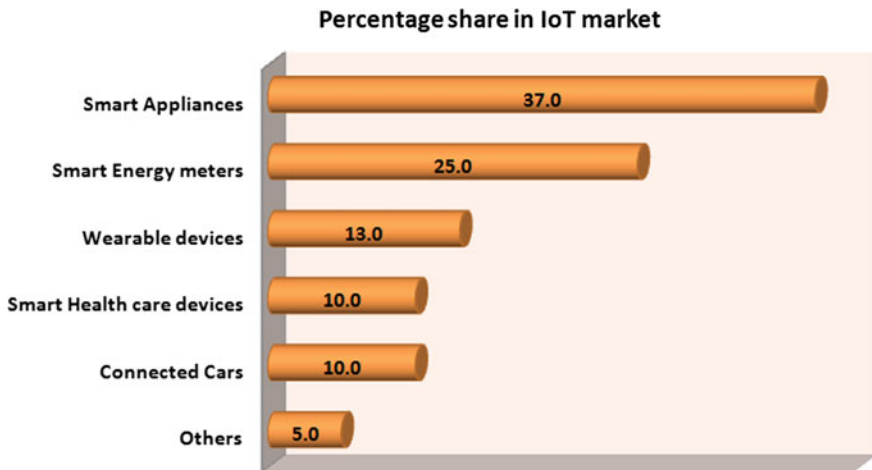
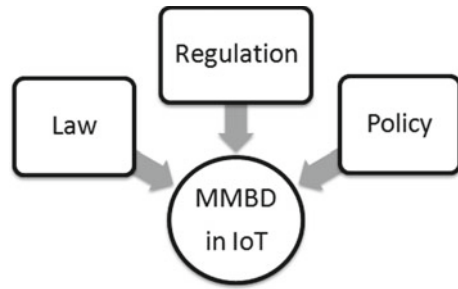

Fig. 1 Market share of smart devices

and organizations. Through IoT, smart homes are the most anticipated feature, with brands as of now getting into the competitive market with brilliant appliances. Wearables are another component inclining second on the web. Apple Watch and other devices will let people consume the interconnected world. Figure 1 illustrates the demand and popularity of different smart devices in the market.

KRC Research surveyed in various developed countries which were aimed to find the smart IoT appliances going to be liked by the consumers in the coming time (see Fig. 1). The research revealed that the customers most preferred smart appliances are smart refrigerator and thermostat customers and appear to change the manner in which we work [12].

Fig. 2 Issues of MMBD in IoT



The extensive utilization of IoT gadgets and MMBD in IoT applications has kept on creating various legal, regulatory, and policy questions notwithstanding the current lawful issues concerning the Internet (see Fig. 2).

The MMBD gathered by IoT gadgets are inclined to abuse and can prompt potential prejudicial and activities against clients or legitimate security class action suits against the maker of IoT devices. Origin of the value of IoT devices stays principal on the capacity of any organization to gather, oversee, and utilize MMBD; security of MMBD from unapproved access and assaults keep on being a prime concern.

Capturing MMBD from IoT application and its analysis promisingly and correctly remains a significant challenge for traditional infrastructure and poses confidentiality and safety threats to the IoT customers.

The failure of different organizations to supervise various complexities of IoT, keep on being a worry because of expanded interest for adequate MMBD management, capacities, and storage, forcing the authorities to rush to discover approaches to address security and protection issues. Most of the countries including the US and the UK have no specific laws and regulations for MMBD in IoT applications.

The strong presence of IoT applications and a large amount of MMBD carries various risks to its stakeholders such as invasive monitoring, unlawful access to private information, an undesirable attack of privacy, etc. MMBD in IoT applications contains systematic and detailed information about the behavior of any person, his family conditions, and personal traits. Misuse of this valuable MMBD may lead to discriminatory practices.

This newly accessible MMBD is required to be stored somewhere. Though, the storage of the MMBD will only be as important as the analytics that can be carried out on it. IoT future depends upon robust infrastructure together with sensor-based technologies and omnipresent broadband connectivity. However, the issue is whether these new generation technologies can persist by way of the growing demand to productively hold up the growth of the IoT applications.

Every new technology brings with it many possibilities, hopes, and issues. The same is also true for IoT. IoT devices collect and route a variety of data from multiple sources ranges from simple text and images to high definition video footage. Such enormous multimedia data collected from the IoT devices are further processed to derive useful patterns and information gives birth to a new Internet tech-

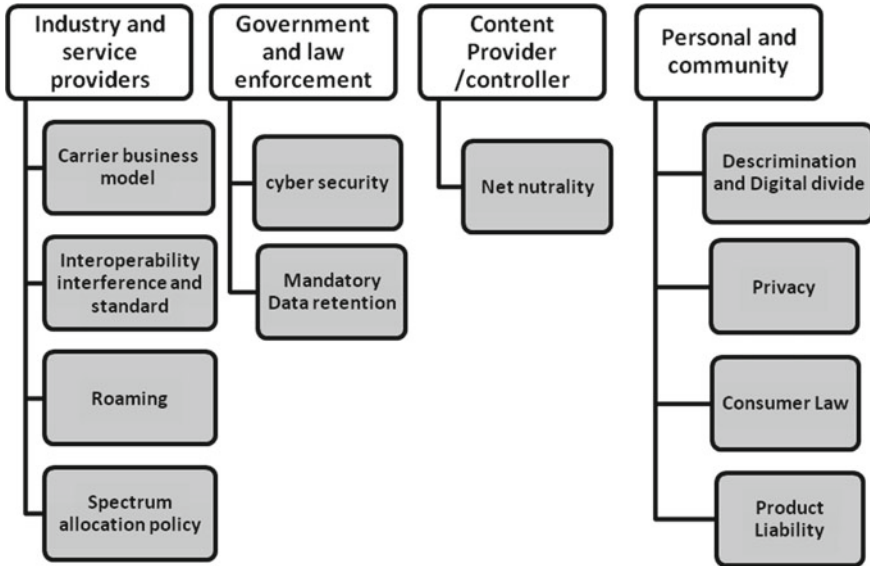

Fig. 3 Issues that different stakeholders face due to the surge of IoT into already evolving IT ecosystem

nology paradigm called Multimedia Big Data (MMBD) in IoT. Multimedia active IoT devices are installed in large numbers from offices to living rooms and from cinema theaters to lavatories are manufactured in bulk, and their design, manufacturing, and operations are either unregulated or are governed by not so strong legislative measures. There exist a multitude of stakeholders who directly or indirectly get affected by the penetration of IoT [13].

Figure 3 shows the stakeholders and the regulatory issues prospectively faced by each stakeholder. The existing regulation of the internet and telecommunications industry has never predicted the fast grow-up of device-to-device communications and does not cater for all facet of the IoT. This chapter looks upon a group of stakeholders of the IoT applications, which generates MMBD, and the legal and regulatory issues that may be of most concern to them.

In an interview with MIT technology review [14], Tim Cook, CEO of Apple, honestly said that the technology should serve humanity; not the other way round. Among the multiple stakeholders mentioned in Fig. 3, the issues faced by the Society and the Individual are, therefore, sensitive and must be dealt with care. Privacy and security of user’s multimedia data is a subject that questions the overall integrity of IoT-based systems and is discussed separately in the following section.

2 Issues of Privacy and Security

Consumer privacy and security are two different but related concepts. Consumer privacy is related to consumer security in that privacy is concerned with consumer's rights that she has to control her personal information and how this information is used; while security governs, the ways in which consumer's personal information is secured [15].

IoT devices in today generate, route and analyze a large amount of multimedia data which due to the lack of proper infrastructural facilities do not do so timely, and also pose a security and privacy threat. Direct attacks like "denial of service" on the IoT networks are possible. The more concerning fact is that any IoT device compromised in the network gives access to other devices as well [16]. Smart TVs store and transmit the information which if compromised put forth a severe privacy issue to the customers [17]. Refrigerators as IoT devices, if compromised with malware, might be used as a source of sending spam emails worldwide by the attacker.

IoT applications involve objects of daily use to connect to the Internet, send, and receive data like implantable medical devices and internet-connected cameras that upload pictures at intervals [18]. IoT applications provide a galaxy of opportunities to make our life comfortable and working more efficient, but they also pose serious challenges in securing the privacy of consumers that would otherwise be exposed to misuse. Even though the universal standards and protocols for IoT are missing, the count of connected smart devices is progressing to become 20 billion by the end of 2020 [15]. Thus, protecting customer's privacy has become an affair of immense importance to the organizations and the governments.

2.1 *The Real Issues*

The real culprits that lead to the privacy and security issues linked to MMBD in IoT are the demeaning of quality over quantity and the unaccountability, both of which are discussed below:

1. **Demand Versus Quality**

Home automation, health monitoring, waste management, smart cities, and all walks of life demand an automated internet-based solution to make human life easier which, as a result, is responsible for a surge in the demand of cheap IoT devices. Most of the IoT devices run on Radio-Frequency Identification (RFID) technology which is a short-range wireless technology that suffers from lack of privacy protocols and also has terrible encryption and security [16]. Thus, in order to meet the demand, quality of the IoT devices are compromised.

2. **The Battle over Ownership**

IoT devices often run on cloud services provided by their vendors. In such cases, it cannot be said decisively that who owns these IoT devices—the vendor or the

customer. Proper legislation is not in place to fix the accountability which results in chaos—the incidence of Apple versus FBI on iPhone security is one example [19]. Mirai, a malware that attacked DVRs and poorly secured webcams in the US in October 2016, is another example where it was unclear that who would be held responsible for this attack—the malware programmer, the unleashing, or the internet’s infrastructure [20].

3 Security Spectrum of IoT Devices

Securities in IoT devices cannot be explained in binary terms—exist or absent. Instead, a security spectrum of IoT device vulnerabilities explains it better. There exist IoT devices that offer no or minimal security at the lower end while medium to high security offering devices is lying on the later parts of the security spectrum shown in Fig. 4. In Fig. 4 a triangle shows a typical IoT device and the number of stars represents the robustness of the device. In a typical got-hit-and-improve system of evolution, network operators and device vendors respond to mitigate the threats or vulnerabilities infused by the attackers into the IoT network.

Consequently, the more sophisticated IoT devices that lie on the upper side of the spectrum tend to come at higher prices than its lower end counterparts [21]. A user who cannot afford to bear any security risk as in the case of a person who has a medical IoT device implanted under his belly, he may be justified in spending a higher price to protect his device from attack. Where a user is little concerned over the theft or privacy of his data like in the case of the data about the number of steps he had taken on a specific day, may go for a device in the lower end of the spectrum.

On ethical grounds, the vendors of IoT devices should not make IoT objects to be exposed to the MMBD of their customers. However, on the business and economic grounds, manufacturers of IoT devices display some propensity in reducing cost, offering simplicity and time to market their devices [22]. This can be understood from the example of types of equipment that have inbuilt IoT devices. If the memory and processing power of such a device is increased to provide enhanced security, the increased cost of the equipment will hurt its competitive advantage.

Economically, security-deficient IoT devices result in a cost that is suffered by a third party (parties). This can be understood by taking the example of an industry that is minting money by manufacturing units and dispose of the industrial waste

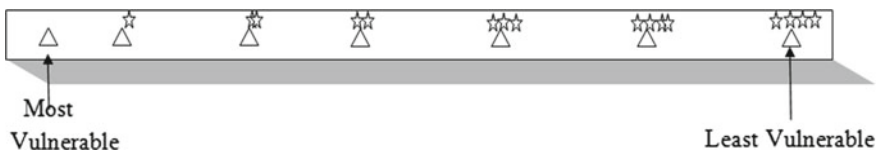

Fig. 4 Spectrum for risk vulnerabilities in IoT devices

into the rivers and smoke in the air. The industry here doesn't take proper measures to curb pollution, but the victims are those who inhale the polluted air or drink the river water. In the case of pollution, the authorities can impose some penalty on the industry to discourage them from creating pollution, but in general, such costs to be borne by a third party are not taken into account during decision-making. In the case of information security, the vendors making the IoT devices do not bear the cost due to the security breach [23]. Thus, accountability laws are the need of the time that forces the vendors into making more security compliant IoT devices.

4 Unique Security Challenges in IoT Devices

IoT devices tend to differ from traditional computing devices in several ways that affect security. A few idiosyncrasies of the IoT devices are listed as follows.

4.1 Scale of Deployment

Unlike other internet computing devices, IoT devices are built to be deployed in bulk. As a result, a complex network of interconnected devices comes into existence. Since any device on this network may potentially establish a link with any other device by its own dynamically and unpredictably, the potential count of such links is infeasible to estimate, and existing methods, tools, and strategies associated with IoT need to be reconsidered.

4.2 Issue of Homogeneity

IoT-based systems generally have a collection of similar devices. The drawback of this approach is that vulnerability in one class of devices would expose the other characteristically similar connected devices to cyberattack. For example, the weakness in the security protocol of one line of product from an organization will extend to every make and model of a device that uses the same protocol.

4.3 Longevity

Though it may appear to be a boon, it is also a curse. IoT devices often outlive the companies that manufactured those devices without necessary support and service. Some IoT devices are installed in the environments where to fix and reconfigure them is practically impossible. This nature of IoT devices provides a contrast to the

conventional computer systems which are upgraded along with the operating system to counter security threats throughout the lifetime [24]. Thus, the long-term support and management of IoT devices is a critical security challenge.

4.4 Lack of Transparency

Users have little or no understanding of the internal working of the IoT devices. This tantamount to the security breach, primarily, when a user expects an IoT device to perform in some way while the device collect, analyze, or transmit the user's data in an unintended way. The device could also start functioning differently with a software upgrade by the manufacturer leaving the user data vulnerable to misuse.

4.5 Protective Legislation

Certain members of the industry have lobbied for protective legislation that allows companies to release IoT software without disclosing known security threats. Such legislation would also intend to exempt manufacturers from any liability for the damages resulting from these known defects. It constrains others from disclosing the known security issues without the permission of the manufacturer. It would also allow the developers to incorporate "self-help" software within a device that can disable the operation of the device, and exempt the developers of the device with "self-help" from damages should a third party disable the device. However, many people feel that the protective legislation, if improperly drafted would lead to conflict with the code of ethics by indirectly exempting manufacturers of their responsibility to provide security into the IoT devices [25].

The privacy challenges in the era of IoT must be taken seriously because the privacy issues are concerned with the fundamental rights of the users and the ability of the users to trust the internet and the connected devices. Some privacy challenges posed by the expansion of IoT devices are discussed as follows.

4.6 Problem of Consent

Unlike banking or other commercial websites that respect their user's consent by making him agree on certain privacy conditions by checking on "I Agree" checkbox, various IoT devices do not offer such a feature owing to the lack of a mechanism for user interaction. In many IoT configurations, users have no idea about the way in which their personal information is being collected and used. Even if a mechanism to interact with the user to get his privacy consent is developed, it will be impossible to interact with every IoT device to configure it for privacy requirements.

4.7 Threat of Societal Norms

A person's expectation of privacy is different in public places and private places, owing to individual perception and societal norms. The ubiquity of IoT devices poses a threat to this privacy expectation of people. For example, a person might expect a different nature of privacy in his car than on the public park. The presence of sensors, cameras and other IoT devices inside the cars and houses of the people offer challenges to the privacy of the individuals. Similarly, the increased presence of surveillance cameras and other IoT devices in public places may collect and process more data than expected.

4.8 Threat of Proximity

IoT devices collect data of all individuals, who are in their proximity whether or not they intend to offer it. For example, in a car, the data of all individuals sitting in the proximity of a device will be captured and sent while only one of those could have consented to it. In such circumstances, it might be difficult to honor peoples' privacy preferences.

4.9 Threat of Discrimination

IoT devices can collect information about people with complete details. Big data analytics on this aggregated and correlated information may construct profiles of individuals or groups that create the potential for discrimination.

4.10 False Sense of Security

IoT devices and systems are getting a warm welcome by society at large. This social acceptance gives a false sense of security and motivates individuals to divulge their sensitive and personal information without knowing the possible consequences.

4.11 Maintaining Anonymity

Network interfaces typically use MAC addresses to trace back the path of digital communication. The combination of multiple MAC addresses forms the footprints to profile an individual's activity and location. Thus, the anonymity of Internet users

is always at risk, and it is crucial to find new methods to anonymize the data communication path to preserve the privacy of the user. With the increased use of sensors and other IoT devices along with big data analytics, a threat to preserving the individual's anonymity becomes an important task.

The ever-increasing use of IoT devices poses new sets of challenges that demand the attention of legislative and regulatory measures. Sometimes, IoT devices seemingly violate the existing civil rights and create new regulatory and legal situations that were unavailable earlier. While at other times, these devices create a broader outlook of the already existing legal issues. Thus, the presence of IoT devices in the markets, households, offices and other public places make a perfect case for relooking at the existing legislative and regulatory measures to curb the misuse of personal information of the billions of users whose trust on this Internet-based system of connected devices is at stake.

5 Other Key Issues and Stakeholders

5.1 *Key Issue: Interference, Interoperability, and Issues of Weak or No Standards*

Stake Holder Profile: Service Provider and Industry

Discussion:

IoT as a concept has proved its worth in many applications that several major technology players have already invested their fortunes into the development of IoT support systems. A large number of connected IoT devices also pose a stack full of challenges including interoperability and interference issues. However, for successful deployment and hassle-free use the devices should be interoperable for a range of standards and at the same time devices must be interference averse too. Thus, industry standards should be set in place for IoT devices to offer interference-free interoperability (IFI).

5.2 *Key Issue: Numbering Plan Issues*

Stake Holder Profile: Service Provider and Industry

Discussion:

Currently, two types of IP address systems are prevailing: IPv4 and IPv6. IPv4 being the most used system has no vacancy left for Asia, Europe, and the US. IPv6 which offers trillions of addresses also provides better security and interoperability along with efficient network management. Therefore, organizations are required to speed up their process of upgrading their network operated hardware to avoid cutting off

their ability to cater to the needs of their customers [26]. No Internet authority has yet published a clear policy on the effect that this network of interconnected devices over the Internet (IoT) has on the service levels, demand and fee structures regarding IP addresses. It is a matter of excitement to watch how the information industry answers to the demand that IoT has on IP addresses.

5.3 Key Issue: Roaming

Stake Holder Profile: Service Provider and Industry

Discussion:

Because a large number of IoT devices will be movable, policies and agreements on changing network boundaries become essential. As of now, various countries do not have any regulations over domestic roaming, which is governed by agreements and arrangements between different carriers. There is a need to form a well-defined inter-carriers tariff structure not to impede the momentum of IoT growth. Effective inter-carrier roaming services are a need of the time to surmount the pressure on network bandwidth due to the surge in IoT devices.

5.4 Key Issue: Spectrum Allocation Policy

Stake Holder Profile: Service Provider and Industry

Discussion:

Mushrooming of IoT devices also claims its share on an already burdened free bandwidth. A typical IoT device is connected through WiFi or Bluetooth to a nearby mobile phone, which in turn is connected to the cloud through a fixed or cellular network. The wireless channel that was already carrying huge mobile traffic is now saddled with this new kind of traffic. For the smooth functioning of IoT, the ISM band must be large enough to accommodate traffic so that the bulk of data packets would flow smoothly. Current spectrum allocation schemes are not flexible in describing apparatus, class, and spectrum license type. Thus, there is a need to develop flexible frameworks to cater to the needs of growing users and uses.

5.5 Key Issue: Net Neutrality

Stake Holder Profile: Content Provider

Discussion:

Net Neutrality requires that there must not be any form of discrimination or interference with data, including blocking, degrading, slowing down, or granting preferential

speeds or treatment to any content. The issue is that such a kind of neutrality will also have a conflict of interest with critical IoT services or specialized services. For example, remote surgery operations should get preference over bandwidth and other networking resources due to minimum tolerance for the quality of service. This can be compared to ambulances which often break traffic rules to provide quality of service legally. Thus, an agreement should be made between the ISPs and the authorities over exceptions before providing licenses. In India recently two of the significant American IT giants, including Facebook, have announced zero-rating plans that faced the criticism of many net-neutrality flag bearers. It was supposed that such kind of allowances would give American giants an unfair advantage over burgeoning local startups. India in 2016 banned Facebook's Free Basics program.

5.6 Key Issue: Cyber Security

Stake Holder Profile: Government

Discussion:

Considering the ubiquity of IoT devices, the security of user data becomes more critical. The range of IoT devices over a variety of networks has increased the space for cyberattackers to target. Typical IoT devices do not possess security features such as encryption, due to their low power operating requirements [17], which would otherwise require high computational capabilities and hence more power. Similarly, the networks that allow these low power IoT devices to establish a connection are also prone to cyberattacks.

Attackers are becoming better equipped with, and it is becoming harder to deal with them. A more significant number of functional IoT devices also offer more possibilities for cyberattackers. HP in a study conducted in 2014 [27] revealed that around 70% of the IoT devices are attacked vulnerable. What causes more concern is the fact that nowadays, organizations own only a fraction of the data that flow through their network. Security circle must, therefore, envelop networks beyond the limits of the organizations. In the absence of strong legislation, cybersecurity risks created by IoT need a specific response. Though IoT related legislation would never be sufficient given the ever-changing nature of IoT technologies, but still some notification legislation

5.7 Key Issue: Mandatory Data Retention

Stake Holder Profile: Government

Discussion:

Internet Service Providers (ISPs) are required to provide some data to certain government authorities and bodies. Telecommunication carriers and ISPs are also instructed

to store the data for the specific duration so that it can be used in case of surveillance or investigations [28]. This data is usually meta-data and covers information about the type and size of the content (e.g., 1 KB of email), the address to which the message was sent to, the address from which the message was sent, and the location of the user device. The rule of data retention does not apply to the content of the data. The question that needs to be addressed in the context of IoT is regarding the ownership that who would be held responsible for storing the data? Customer, cloud service operator or the device manufacturer.

5.8 *Key Issue: Ethical Issues*

Stake Holder Profile: Individual and the Society

Discussion:

IoT as a technological establishment has raised some ethical questions [29]. Though IoT claims to bridge the gap between the rich and the poor, the urban and the rural, in reality, it does not seem to do so [30]. Various societies and places have no access to the internet due to the lack of infrastructure or financial resources which accounts for unreachability of certain services and benefits meant to be offered through this medium. Big-nudging is another ethical issue [31] which is used to subtly manipulate the society to nudge it towards a specific outcome. This is done by drawing the insights from the consumer's data and uses these insights to learn the thoughts, feelings, and behavior of individuals.

5.9 *Key Issue: Discrimination and the Digital Divide*

Stake Holder Profile: Individual and the Society

Discussion:

Discrimination is the capability to determine the user's demographic behaviors all the way through algorithms and aggregation of MMBD has an impending danger beyond just privacy concerns.

The profiling and aggregation of client information may prompt marginalization and make new open doors to digital discrimination [32]. Refusing access to financial services by the bank based on the communities from which needy applicants come has a long history. Sometimes this practice is called "redlining" [33].

In IoT, there is a term "Sensor fusion", which provides the capacity to join data from two separated sensing devices to make more noteworthy and more mind-boggling information. This can prompt the controllers of the MMBD profiling IoT application consumers based on a limitless number of attributes, e.g. race, sexual orientation, level of action, work, financial status and so on [34].

This can prompt consumers being looked with exceptionally focused on and greedy strategies of marketing that go after their recognized practices, examples and inclinations. For instance, individuals in money related trouble might be drawn nearer by finance companies offering them a loan at a high-interest rate, when they would least be able to bear the cost of it.

The least IoT application user group such as elderly persons or relatively poor community may likewise end up progressively unimportant. For instance, in some country, a mobile App is used to spot potholes on the streets of inner city areas [35]. It helped the city's Public Works Department to focus on road maintenance of the affected regions of the city. In any case, given poor people and elderly persons might be less inclined to download the application, there were concerns the city's administrations could be redirected far from the territories that need most consideration for more youthful and wealthier neighborhoods.

The MMBD data that can be generated and managed by the IoT application can be of enormous importance, yet measures must be set up to guarantee that regardless how much intentional or unintentional, the data does not prompt unintended outcomes in opposition to the public development policies. It may also happen that one service provider may refuse to transfer data to other service providers as per the needs of the customers. The MMBD, after a certain length of time, may become necessary to other service providers like critical health management services, but an uncompetitive attitude of service providers will work as a deterrent to make this transfer happen.

The automated decision-making and its backend technologies are not at all transparent, and to a great extent unavailable to the typical individual [36]. However, they are expecting growing significance and being utilized in many vital contexts of human life like health, employment, credits, goods, education and many more. This blend of conditions and innovations raises hard questions regarding how to guarantee that digital discrimination impacts which resulted from automated processes of decision-making, regardless of whether deliberated or unintended, can be distinguished, estimated, and reviewed.

6 The IoT Consumer and the Challenge of Transparency

In this hyper-connected world, one can easily imagine the realities for IoT Consumers. We are the potential consumer of novel new IoT devices, as well as already connected to networks and services, such as through TVs, home assistants, smart energy meters, smart cities, and smart transportation. There is often divergence on what is the rigorousness of the transparency challenge.

We are entirely agreed on the significant challenges for IoT consumers in the present approach to providing an accepting of why, where and how our data is used. The visibility, transparency, and control are found to be the major challenges in the field of MMBD in IoT application. Usually, this is practiced by using the provisions of information in the form of terms and conditions and privacy policies with the facility to amend settings.

7 Trust and the Inevitable Increase of Regulation on MMBD in IoT

Trust plays a significant role in the acceptance of IoT applications, among organizations and IoT consumers. Trust on the subject of transparency, security, privacy, discrimination in MMBD usage, etc. According to the Edelman Trust Barometer (2017) [37], there exist constant low levels of trust concerning technological evolutions including IoT. It as of now begins with essential levels of trust, for example, the trust in IoT gadget producers to give data collection Information.

Figure 5 illustrates the trust data of 2016 collected from various IoT consumers in Europe [38].

A significant part of European IoT customer, around 39% said they disagree the way that IoT organizations give adequate data about the information/data they gather. Another 42% of consumers reasonably oppose this idea. The results of the survey indicate that the overall trust scenario is not good. All things considered, one of the essentials of the GDPR is that the end user (IoT consumer) needs to give agreement, clearly and visibly unambiguously. Also, consistently users have the privilege to know the what, why and who of the handling of their personal information.

The Global Privacy Enforcement Network [6] conducted another research. 25 data protection regulators worldwide participated in this research. The results are shocking. 59% IoT gadgets failed to convey about the process satisfactorily, and motive of the collection of users personal data. 68% devices failed to explain the data storage process. 72% of devices did not clarify users about the process of data deletion from the devices.

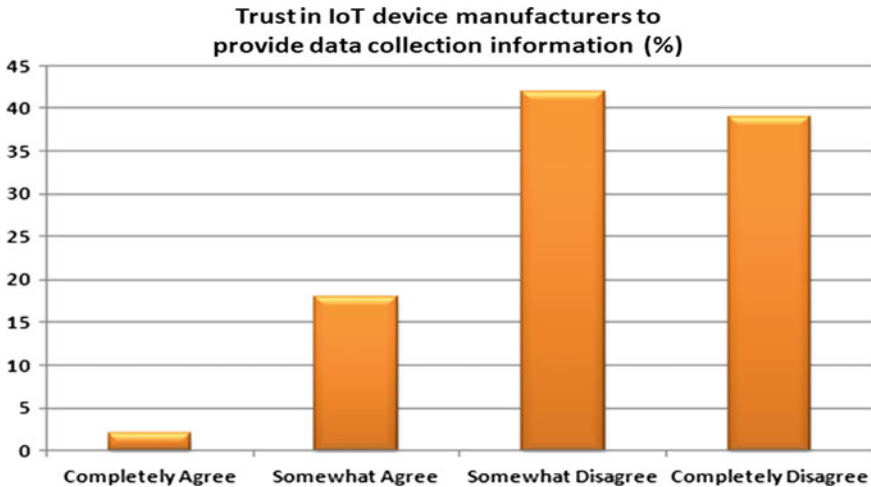

Fig. 5 Trust of consumers in data collection information

It is expected that more regulations, laws, and policies should be made not only in European countries but throughout the world. Do expect more regulations in the interconnected platform of IoT, AI, and robotics. IoT is today's new reality: an absence of consideration for security and individual information will not go on without serious consequences as the growing of stakes and increase in risks.

8 Regulatory Bodies and Government

The present consumer lawsuit will, for the most part, apply in consumer transactions. Present framework precludes misdirecting, or misleading behavior infers statutory assurances into individual contracts with the consumer. It also establishes a product accountability management and may likewise void contracts which are unjustifiable or unconscionable. The current framework of privacy protection will likewise apply where an individual (under regulation) gathers, utilizes, or reveals individual data about an end user.

The swift advancements in information technology particularly in IoT are changing how individuals function, spend time, play, and cooperate. The policies of the government will inevitably impact the bearing of innovative development and regulations and laws will without a doubt need to face the new reality and challenges efficiently.

To enforce the standardization and legal efforts, independent regulatory bodies, government, or both must show the way [39]. The efforts of standardization must involve certification practice together with the technological development process. Be that as it may, these efforts should not block the innovations and technology development but instead guarantee interoperability among different technological solutions of IoT, competition, and marketplace. The standardization of storage and MMBD data processing and the transfer will inevitably diminish the entry blockade to the marketplace of IoT.

It is imperative to build up an administering body like the World Wide Web Consortium for the IoT to control and govern the efforts of standardization and certification [40]. Few crucial areas of standardization may include Data modeling, routing, user permission mechanism, exchange of MMBD, device description and discovery, encryption and routing.

As expressed already, the endeavors to standardize these areas must be synchronized with the necessary certification process. Now a day, the IoT service companies are trying to certify their IoT devices and applications on their own. Regrettably, these efforts will deter interoperability.

In order to inculcate the transparency and fairness, the mechanism of certification for the IoT devices and its MMBD would be analogous to the certificate authority model of the Internet. Nevertheless, the model of IoT certification would be significantly more extensive since it may need to ensure both software services and hardware product/devices [41].

8.1 General Data Protection Regulation (GDPR)

The increased cyberattacks and privacy breaches forcing the government to impose strict regulations. The General Data Protection Regulation (GDPR) of European Union (EU) is the most recent effort to mitigate these kinds of activities. Although the EU adopted this regulation in 2016, it became effective on May 25, 2018. This Regulation has broad consequences. In this regulation, a range of identifiers is pointed out they are called online identifiers. These openly include Radio Frequency Identification (RFID) tags. Furthermore, the list of online identifiers is not extensive [13].

A standout amongst the unique components of the new regulation is the reporting of the incidents of the data breach within 72 h to regulators. This applies to the European organizations and, in some situation, organizations across the world that handle data from individuals in the EU. The punishment for neglect to do as such is steep—up to 4% of an organization’s yearly worldwide income. Different nations like Japan, Singapore, and Australia are also adopting similar laws for privacy and cybersecurity.

9 Future Challenges

In an article by Open Mind [42], few trends of IoT are discussed which also offer specific challenges that need to be tackled in the future, and are presented as follows.

9.1 Platforms

To overcome the management of the exponentially growing population of IoT systems, platforms play a crucial role. With passing time, IoT devices will cost pennies, IoT based applications will multiply, and operation cost is going to be inexpensive. IoT platforms integrate a varied collection of infrastructural components and services all in one place making it convenient to handle associated complexities. The future challenge is to efficiently calibrate the low-level services offered by such platforms as communication, monitoring and regular updates of the IoT devices; improving data acquisition and routing capabilities; and application development including analytics and visualization.

9.2 Ecosystems Warfare

With the growth of IoT devices various new and new ecosystems which include processors, aggregators, operating systems and platforms [43] are bound to emerge. Some ecosystems will offer security but might not be so viable commercially. Some ecosystems would offer a boost to your business but may also expose your organizational or personal information at risk. Therefore, organizations will have to cope up with the developing and conflicting ecosystems and standards by making their devices remain compatible through means of regular updates.

9.3 Low-Power Architecture

Making devices that understand the low power requirements of IoT systems while keeping their security jacket impervious need skills and is a pertinent challenge to overcome.

9.4 Advanced Analytics

In a couple of years, trillions of IoT devices generation petabytes of MMBD will populate the world. The traditional analytics will no longer remain useful and thus a challenge to design and develop algorithms to transform this bulk of MMBD into useful information to take the decision and perform actions to make human life more comfortable and safe.

9.5 Security

No matter how robust an IoT device is today, it will not remain so tomorrow. Cyber-attackers are becoming more sophisticated and learned by each passing day making the life of an IoT engineer difficult. Developing devices to outsmart attackers is a continuing challenge and is expected to remain so in the coming future.

9.6 Smaller Time Window

The governments and companies that operate on power grids and other critical infrastructure have relatively a shorter window to frame new policies and regulations for IoT [44]. With the continuous surge of IoT devices, the governments will tend to

observe fewer opportunities to act and mitigate the risks, thus making it essential to work on the legal and regulatory framework to handle this transformation.

10 Conclusions

Receiving data of every nature from multiple sensors, processing it in real time, and taking appropriate action is all that an IoT-based system does. MMBD generated by the IoT devices is prone to many privacy and security issues. IoT devices generally operate on low-power batteries due to which sophisticated security measures cannot be embedded in them. Lack of proper legal frameworks around the globe intensifies the problem of security and privacy in IoT to the next level. Homogeneity in IoT devices exposes them to the cyberattacks which are worsened by the lack of services and support from the manufacturers due to the property of longevity that exists in IoT devices. These IoT devices sometimes violate the civil rights in a country and create a new set of interwoven privacy and security issues that are impossible to be handled by the existing regulatory provisions. Thus strict penalties are needed to be imposed on the offenders and misusers of MMBD, and an adequate legal framework that addresses the regulatory and legal issues for MMBD in IoT are required.

References

1. S. Tanwar, P. Patel, K. Patel, S. Tyagi, N. Kumar, M. S. Obaidat, An advanced internet of thing based security alert system for smart home, in *IEEE International Conference on Computer, Information and Telecommunication Systems*, Dalian University, Dalian, China, pp. 25–29 (2017)
2. K. Britton, Handling privacy and security in the internet of things. *J. Int. Law* (2016). <https://www.coursehero.com/file/16667577/Handling-Privacypdf/>
3. A. Kumari, S. Tanwar, S. Tyagi, N. M. Maasberg, K.K.R. Choo, Multimedia big data computing and internet of things applications: a taxonomy and process model. *J. Netw. Comput. Appl.* **124**, 169–195 (2018)
4. L. Atzori, A. Iera, G. Morabito, The internet of things: a survey. *Comput. Netw.* **54**(15), 2787–2805 (2010)
5. J. Vora, P. Italiya, S. Tanwar, S. Tyagi, N. Kumar, M.S. Obaidat, K-F. Hsiao, Ensuring privacy and security in E-Health records, in *International Conference on Computer, Information and Telecommunication Systems (IEEE CITS-2018)*, Colmar, France, pp. 192–196 (2018)
6. A. Kumari, S. Tanwar, S. Tyagi, N. Kumar, Fog computing for healthcare 4.0 environment: opportunities and challenges. *Comput. Electr. Eng.* **72**(1–13) (2018)
7. D. McAuley, R. Mortierm, J. Goulding, the Dataware manifesto, in *Communication Systems and Networks (COMSNETS), Third International Conference* (2011)
8. S. Tanwar, S. Tyagi, S. Kumar, The role of internet of things and smart grid for the development of a smart city, in *Intelligent Communication and Computational Technologies (Lecture Notes in Networks and Systems: Proceedings of Internet of Things for Technological Development, IoT4TD 2017)*, Springer International Publishing, Vol. 19, pp. 23–33 (2017)
9. J. Schultz, The internet of things don't own. *Commun. ACM* **59**(5). <https://doi.org/10.1145/2903749> (2016)

10. <https://www.informationweek.com/mobile/mobile-devices/gartner-21-billion-iot-devices-to-invade-by-2020/d/d-id/1323081>
11. Gartner report on the market of IoT devices. <https://www.gartner.com/newsroom/id/3165317>
12. S. Kashyap, 10 Real World Applications of Internet of Things (IoT)—Explained in Videos. <https://www.analyticsvidhya.com/blog/2016/08/10-youtube-videos-explaining-the-real-world-applications-of-internet-of-things-iot/>
13. M. Goddard, The EU General Data Protection Regulation (GDPR): European regulation that has a global impact. *Int. J. Mark. Res.* **59**(6), 703–705 (2017)
14. <https://www.technologyreview.com/s/608051/tim-cook-technology-should-serve-humanity-not-the-other-way-around/>
15. C. Chike, The Legal Challenges of Internet of Things. Bowie State University (FTC), F. T. (2018). <https://www.ftc.gov/news-events/press-releases/2017/01/breathometer-marketers-settle-ftc-charges-misrepresenting-ability>
16. H.M. O'Brien, The internet of things. *J. Int. Law* **19**(12) (2016)
17. <http://www8.hp.com/us/en/hpnews/pressrelease.html?id=1744676#.VrLf0nJf2Gk>
18. K. Britton, Handling privacy and security in the internet of things. *J. Int. Law.* <https://www.coursehero.com/file/16667577/Handling-Privacypdf/>
19. H. Pressman, R.S., *Software Engineering: A Practitioner's Approach* (5th ed.). Boston, Mass.: McGraw Hill. (2017)
20. A. Abobakr, M.A. Azer, IoT ethics challenges and legal issues, in *12th International Conference on Computer Engineering and Systems*, Cairo, pp. 233–237 (2017)
21. A. Asin, D. Gascon: 50 Sensor Applications for a Smarter World (2012). http://www.libelium.com/resources/top_50_iiot_sensor_applications_ranking/
22. S.S. Bhadauria, V. Sharma, R. Litoriya, Empirical analysis of Ethical issues in the era of future information technology, in *2nd International Conference on Software Technology and Engineering*, San Juan, PR, USA (2010)
23. H. Sundmaeker, P. Guillemin, P. Friess, S. Woelffle, Vision and challenges for realising the internet of things. *Cluster of European Research Projects on the Internet of Things* (2010)
24. R. Roman, P. Najera, J. Lopez, Securing the internet of things. *Computer* **44**(9), 51–58 (2011)
25. I. Baker, McKenzie, Internet of things: some legal and regulatory implications (2016)
26. J. Stankovic, Research directions for the internet of things. *Int. Things J. IEEE* **1**(1), 3–9 (2014)
27. Apple vs. FBI: What's going on? (2016, February 23). Retrieved October 7, 2018, from KasperSky. <https://www.kaspersky.com/blog/apple-versus-fbi/11381/>
28. Edelman Trust Barometer. <https://www.edelman.com/trust2017/>
29. Ethical Pitfalls and the Internet of Things. <https://aquicore.com/blog/ethical-pitfalls-internet-things/>
30. D. Popescu, M. Georgescu, Internet of things-some ethical issues. *USV Ann. Econ. Public Adm.* **13**(2) (2013)
31. M. Pandey, R. Litoriya, P. Pandey, An ISM approach for modeling the issues and factors of mobile app development. *Int. J. Softw. Eng. Knowl. Eng.* **28**(7), 937–953 (2018)
32. B.G. Edelman, M. Luca, Digital Discrimination: The Case of Airbnb.com (2014). Retrieved from <https://hbswk.hbs.edu/item/digital-discrimination-the-case-of-airbnb-com>
33. A. Srivastava, S.K. Singh, S. Tanwar, S. Tyagi, Suitability of big data analytics in indian banking sector to increase revenue and profitability, in *3rd International Conference on Advances in Computing, Communication & Automation*, Tula Institute, Dehradun, UA, pp. 1–6 (2017)
34. Peppet, Scott: Regulating the Internet of Things: First Steps Toward Managing Discrimination, Privacy, Security, and Consent, *93 Tex. L. Rev.* **85** (2015)
35. K. Finch, O. Tene, Welcome to the Metropicon: Protecting Privacy in a Hyperconnected Town, *1581* (2014)
36. Big Data: Seizing Opportunities, Preserving Values. The White House Report Washington (2014)
37. <https://www.statista.com/statistics/609021/trust-in-iiot-device-manufacturers-eu/>
38. GPEN Privacy Sweep, Internet of Things: Participating Authorities' Press Releases. <https://www.privacyenforcement.net/node/717>

39. R.H. Weber, Internet of things—need for a new legal environment? *Comput. Law Secur. Rev.* **25**(6), 522–527 (2009)
40. R. Litoriya, A. Kothari, Cost estimation of web projects in context with agile paradigm: improvements and validation. *Int. J. Softw. Eng.* **6**(2), 91–114 (2013)
41. C. Perera, R. Ranjan, L. Wang, S.U. Khan, A.Y. Zomaya, Big data privacy in the internet of things era. *IT Pro*, 1–9 (2015)
42. <http://connectedcityusa.com/2017/11/connected-device-forecast-federal-regulations-and-the-future-of-iot/>
43. S. Tanwar, S. Tyagi, N. Kumar, M.S. Obaidat, *Ethical, Legal, and Social Implications of Biometrics Technologies, Biometric Based Security Systems*. Springer (2018)
44. F. Jindal, R. Jamar, P. Churi, Future and challenges of internet of things. *IJCSIT* **10**(2), 13–25 (2018)

Part IV
Application Environments

Recent Advancements in Multimedia Big Data Computing for IoT Applications in Precision Agriculture: Opportunities, Issues, and Challenges



Shradha Verma, Anshul Bhatia, Anuradha Chug and Amit Prakash Singh

Abstract This chapter aims to present a survey on the existing techniques and architectures of Multimedia Big Data (MMBD) computing for Internet of Things (IoT) applications in Precision Agriculture, along with the opportunities, issues, and challenges it poses in the context. As a consequence of the digital revolution and ease of availability of electronic devices, a massive amount of data is being acquired from a variety of sources. On one hand, this overwhelming quantity of multimedia data poses several challenges, from its storage to transmission, and on the other, it presents an opportunity to provide an insight into the business trends, intelligence and render rich decision support. One of the key applications of MMBD Computing is Precision Agriculture. The chapter focuses on major agricultural applications, cyber-physical systems for smart farming, multimedia data collection approaches, and various IoT sensors along with wireless communication technologies employed in the field of Precision Agriculture.

Keywords Multimedia Big Data (MMBD) · Internet of Things (IoT) · Precision agriculture · Digital revolution · Sensors · Data analytics · Data collection in agriculture · Smart farming · Plant pathology

S. Verma (✉) · A. Bhatia · A. Chug · A. P. Singh
USICT GGSIP University, New Delhi, India
e-mail: verma.shradha@gmail.com; shradha.usict.122164@ipu.ac.in

A. Bhatia
e-mail: anshul.usict.127164@ipu.ac.in

A. Chug
e-mail: anuradha@ipu.ac.in

A. P. Singh
e-mail: amit@ipu.ac.in

1 Introduction

With the advent of the digital revolution and constant generation of user content online through a plethora of electronic gadgets and social media, there arises a challenge on how to deal with such vast amounts of Multimedia Big Data (MMBD) [1]. From collection to storage, processing, analysis, and presentation, it comprises of a cumbersome task. Conventional data processing tools are insufficient to process these complex datasets as the data scale reaches up to petabyte levels. Due to its unstructured and heterogeneous nature, we face additional problems, viz., compression, analysis, interpretation, transmission, and distribution as well as the issues of scale and complexity. Nevertheless, MMBD can be utilized to provide greater opportunities and insight into the context. With the analysis of such huge amount of data, we can build better computational models leading to better decision-making, further applicable to a multitude of real-life domains, agriculture being one of the crucial fields. Precision agriculture necessitates the use of automated and innovative technologies for data collection and analysis in plant pathology. Research work spanning more than a decade has led to several algorithms and techniques that apply the advancements in the computing technologies to the field of agriculture. Given the restricted access to resources and limited expertise, there is a dire need for automated processes for smart farming. Agriculture is dependent on several factors such as soil quality, climate, temperature, humidity, rainfall, irrigation, fertilizers, etc [2]. Internet of Things (IoT) sensors can be used to create an intelligent system in which various environmental parameters such as temperature, humidity, pressure, CO₂, water level, etc., along with images, can be observed and acquired for analysis. Data clustering and data mining techniques can be exploited to discover patterns in the dataset. IoT allows the unification of various communication technologies, IP protocol and embedded devices, to create a smart system that interacts constantly with both real as well as digital worlds simultaneously. It imbibes daily objects with intelligence that can acquire and share information, as well as control the physical aspects of the world. Analysis and interpretation of the MMBD collected from these pre-configured IoT sensors can be employed to optimize the production and quality of the crops.

The major contributions of this chapter are enlisted as follows: (a) broad review of the existing literature on generation of multimedia data in the field of precision agriculture, (b) exploration of the role of IoT devices/sensors for agricultural data collection along with big data analytics, (c) interpretation of the MMBD computing paradigm and its applications in smart farming, (d) presenting the relevant agricultural applications, IoT sensors and communication modules (summarized in Table 2) and (e) listing the opportunities, issues and challenges along with future directions in the context.

1.1 Research Objectives

This chapter aims to present a survey on the existing techniques and architectures of MMBD computing for IoT applications in precision agriculture, along with the opportunities and challenges it poses in the context. Initially, 103 research articles were picked out for this study. Out of these, papers pertaining to specifically precision agriculture were selected along with a few papers on MMBD Computing, published in peer-reviewed, reputed journals and conferences. Remaining papers were not included on the basis of applications, relevance, and quality. The study presented in this chapter attempts to answer the following research questions:

- RQ1: What are the sources of data collection for precision agriculture?
- RQ2: With the use of IoT sensors and big data, what applications in precision agriculture are being worked upon?
- RQ3: What are the commonly used IoT devices for precision agriculture?
- RQ4: What kind of MMBD is being acquired for precision agriculture?

Rest of the chapter is organized as follows: Sect. 2 presents the conceptual framework of MMBD Computing, Sect. 3 introduces the Cyber-Physical Systems for precision agriculture, Sect. 4 lists the data collection techniques in precision agriculture, Sect. 5 presents the role of MMBD and IoT in precision agriculture, Sect. 6 enlists various techniques studied and their usage distribution, Sect. 7 drafts the opportunities and challenges of MMBD and IoT in precision agriculture, Sect. 8 draws a conclusion and Sect. 9 stages the future direction.

2 Conceptual Framework: Multimedia Big Data Computing (MMBD)

With the proliferation of cheap electronic devices such as cell phones, equipped with high-end cameras and unlimited internet usage, it is quite easy for a daily user to produce and exchange data with multimedia content [3]. Sharing of personal data, messages, images, videos, etc., on social networking sites, viz., Facebook, Instagram, Twitter, etc., is a common occurrence.

Privacy, confidentiality, and authentication are the keys factors to be considered in order to provide a secure environment for numerous crucial applications, viz., banking, health care [4, 5], defense, etc. Installed for security reasons, even the surveillance cameras generate an immense amount of continuous video content, not to mention the data generated by the biometric systems for identification purposes [6, 7]. Also, video lectures and demonstrations for educational purposes are growing day-by-day. The sheer volume and heterogeneity of this big data from various multimedia devices requires pertinent storage, processing, and analyzing capabilities from the current systems, both in terms of hardware and software. Analyzing MMBD, which is essentially big data with several media types, requires complex algorithms,

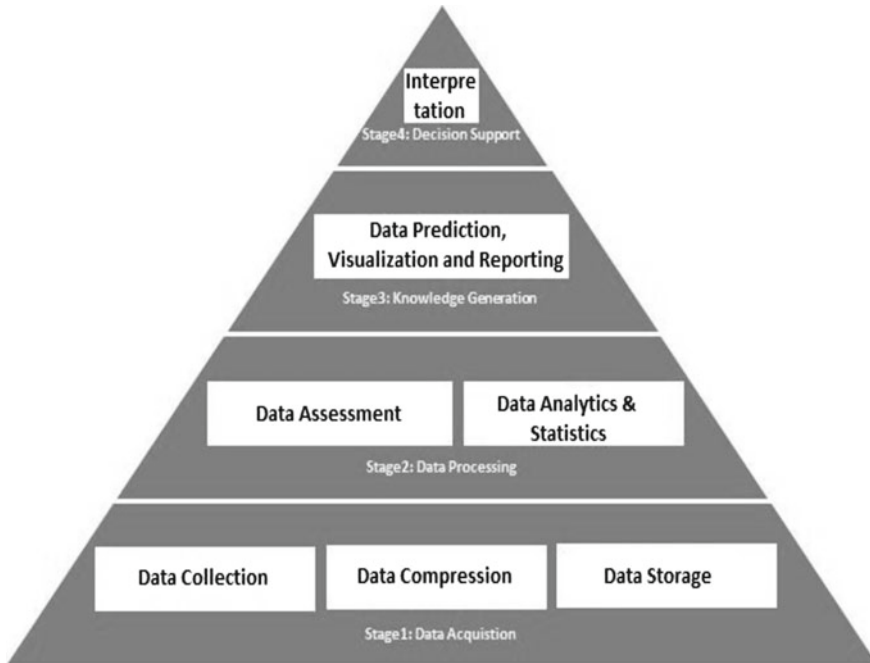

Fig. 1 Basic framework of Multimedia Big Data Computing (MMBD)

parallel and distributed computing, Graphics Processing Units (GPUs), etc., to come into play [8]. MMBD is a useful tool for human perception and understanding but poses several challenges in the context of a machine. Data acquisition from multiple and heterogeneous sources such as cameras, IoT sensors, social media, etc., adds to the unstructured nature of big data, rendering it difficult to model. Hence, there arises a need for data preprocessing that encompasses data cleaning, data transformation, compression and reduction, which is a time consuming task. In addition to voluminous storage, it requires fast processing for real-time computing. Figure 1 shows the basic framework of MMBD computing and its essential processes, divided into four stages namely, data acquisition, processing, knowledge generation and decision support. Raw and unstructured data from multiple sources is collected, preprocessed, stored, and analyzed using novel big data analytics tools, to derive conclusions, and interpretations, for improved decision support.

In spite of the large datasets, researchers are unable to utilize them efficiently, due to the lack of annotations. In recent times, data annotation in itself has emerged as a research area, whereby manual, as well as machine learning based annotation, has been studied with promising results. Understanding and analyzing MMBD via data mining techniques and feature extraction methods can be exploited to uncover patterns and enhance decision-making abilities. With the advent of big data techniques

such as MapReduce, Hadoop, RapidMiner, Spark, and platforms for data science such as R Studio, research has accelerated in this direction.

3 Precision Agriculture and Its Cyber-Physical Management

Cyber-Physical Systems (CPS) are a milestone in the development of computational technologies, having achieved widespread success in applications, viz., automotives, healthcare, manufacturing, entertainment, military, etc., precision agriculture being one of the most significant applications. With the projected population growth of around 9 billion by the year 2050, Food and Agriculture Organization (FAO) of the United Nations, has estimated a need for nearly 60% increase in the agricultural production [9]. From irrigation systems to monitoring crop vegetation and smart pest control, CPS-based architectures for precision agriculture have been proposed in various research articles. A CPS encapsulates the physical elements along with the computational components, integrated and interacting in the real world at every level of complexity and scale, with the help of extensive networking capabilities. With the collaboration of computation, communications, and control (3C) technology, real-time sensing and dynamic control of information can be realized effectively [10].

Figure 2 demonstrates the basic model of a CPS along with its governing factors, i.e., the three Cs, communication, computation and control. IoT and Wireless Sensor Networks (WSN) have a lot in common with the CPS, all comprising of a 4-layered architecture (sensing, networking, analyzing, and application) but CPS dominates the degree of integration and interactions between the physical and computational elements. To analyze the environmental variables, data from multiple sources such as IoT sensors, satellite networks as well as advanced remote sensing techniques, viz., multispectral cameras, hyperspectral cameras, IR cameras, etc., is being captured for smart farming applications, to enhance the quality of the crop yield and early prediction of plant diseases [11].

Rad et al. [12] have presented a CPS-based crop status monitoring system for potato vegetation, whereby multispectral data is captured to compute the vegetation indices, which are helpful in detecting the nutrient content, soil type, water content, etc., for a particular area of the field. This could prove to be beneficial in identifying the profitability of the field and in turn improve decision-making for better economic results. Fresco and Ferrari [13] have emphasized on the correlation between sustainable agriculture and public health, agriculture and biodiversity, and the need for digital dimensions and solutions based on CPS architectures. Also, CPS along with the pre-established paradigms can bring about a revolution in the precision agriculture arena.

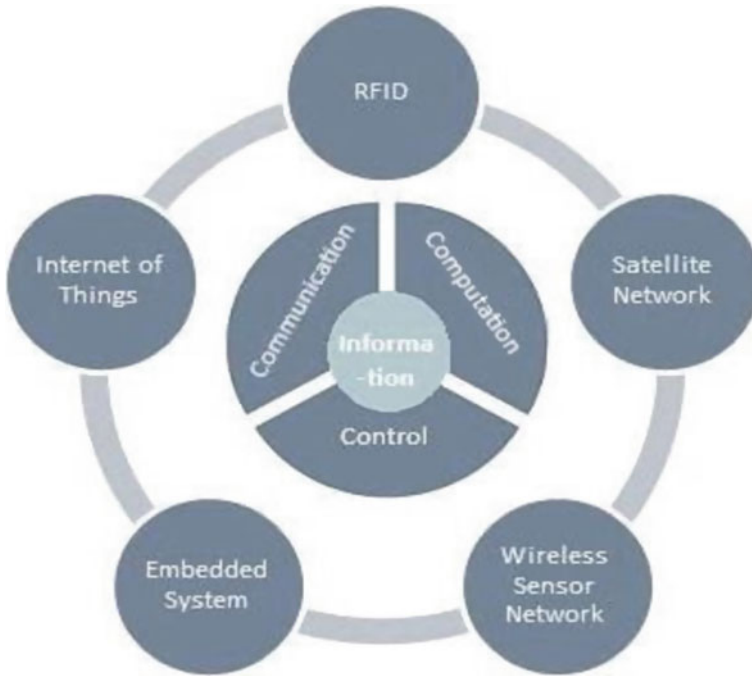

Fig. 2 Basic model of a Cyber-physical System (CPS)

4 Data Collection in Precision Agriculture

As mentioned earlier, data from various sources is being acquired for smart farming applications. There are a plethora of sensors available, to be put to good use for the monitoring of environmental factors dominating the plant growth, along with the imaging and remote sensing techniques utilized for monitoring plant health with minimum human intervention. The humongous amount of data being generated via these techniques can prove to be overwhelming, hence huge database storage and fast and efficient processing is essential. Table 1 lists the data collection techniques studied. These sensors can be installed in the field, on robotic vehicles and/or Unmanned Aerial Vehicles (UAVs).

5 MMBD Computing and IoT in Precision Agriculture

Collaboration of Big Data with Cloud Computing and IoT has transpired a new range of applications spanning multiple domains. But lack of automated processes is a major hindrance in the area of agriculture. Fog computing, a recent technologi-

Table 1 Multimedia Big Data (MMBD) collection methods

Data collection and communication tools	List of available sensors	Type of MMBD
IoT Sensors	Air Humidity and Temperature sensor, Soil Humidity and Temperature Sensor, Light Sensor, pH Sensor, Gas Sensor, Electric Conductivity Sensor, Wind Speed/ Direction Sensor, Pressure Sensor, Liquid-Level Sensor, Water-Level Indicator Sensor, Smoke Sensor, Passive InfraRed (PIR) Sensor, URD Sensor, Thermocouple Sensor, Leaf Wetness Sensor, Rain Volume Sensor, PPF Sensor	Text, Audio
Imaging and Remote Sensing	Digital Cameras, IR Cameras, Multispectral Cameras, Hyperspectral Cameras, Depth Cameras	Audio, Images (Spatial data as well as Spectral Data), Video
Microcontrollers	Arduino, Raspberry Pi, Atmega 128L, S3C2440, CC2420, STM85103F3.	–
Wireless Communication Technologies	ZigBee, WiFi, RFID, Multi-hop, UART, SMS	–

cal progression, similar to cloud computing, is already being studied in the field of healthcare, providing uninterrupted services to the customers. It supports real-time data acquisition and analysis [14], which can be applied to agricultural applications as well. Gill et al. [15] have proposed a cloud-based service for agriculture known as Agriculture-as-a-service (AaaS), whereby the data captured via several pre-configured IoT sensors is sent to the cloud for processing with the help of big data analytics. The processed result reaches customers simultaneously and automatically. With respect to agriculture, the decision-making trends have been passed down through generations of farmers, but now, with the advent of advanced computational technologies and complex data processing capabilities, the massive data being captured daily, can be exploited to establish a Decision Support System (DSS) for smart farming [16]. Similar to health care, agriculture is a broad area that encapsulates several distinct markets from farmers, traders to retailers and customers. In their paper, Pham and Stack [17] have discussed the similarities and differences between conventional and precision agricultural practices, and explained how with the aid of Global Positioning Systems, sensor data and communication systems, precision agriculture is leaps and bounds ahead. Data is the most significant resource with

respect to precision agriculture. Big data has led to the emergence of positions, viz., data scientists, data holders, data analysts, etc. In addition, various firms have sprung up focusing on data collection, storage, and processing, along with providing agricultural prescription services. Carolan [18] has drawn conclusions on the use of big data in precision agriculture on the basis of interviews conducted in Iowa, with several farmers, big data analysts, and entrepreneurs in the local food industry. The discussion on feeding the future generations and flourishing possibilities of exploiting the technology was evident.

IoT has the ability to alter and guide the world in a positive direction. Security alert systems for smart homes [19], smart cities, connected cars, health sector, etc., are the most common applications of IoT in today's scenario. Nevertheless, IoT technologies have a special impact on the field of agriculture. There is an assumption that global population is going to touch the estimated magical number of 9.6 billion till 2050. Therefore, it is a matter of serious concern for the agricultural industry. They must be able to provide sufficient and quality food for the upcoming generations without unnecessary wastage of the essential resources. So, the use of IoT based smart technology named 'Precision Agriculture' will help out the farmers to decrease the wastage of resources and enhance the quality and productivity of crops and food respectively. Precision agriculture refers to a number of unique tools and techniques that are necessary for the precise evaluation of farming requirements. These tools and techniques basically accentuate on the variations of natural components in the farm field, including the amount of water, soil components, drainage, runoff, chemical leakage, etc. The primary goal of the precision agriculture is to use new technologies like sensors, RFID (Radio-Frequency Identification) tags, remote sensing, WiFi, ZigBee, satellites, etc., to precisely measure the variations in a field. Consequently, agronomic activities like pesticide management, irrigation, fertilizer management, seeding, and pest control can be programmed independently based on the evaluation of a farm field. The following section is going to explain these IoT based technologies in detail.

5.1 Sensor-Based Technology

A sensor is a device that senses and reacts to a special type of input from the nearest environment. Sensors are the eyes and ears of IoT, that's why no one can imagine the existence of IoT without the use of sensors. Today, sensors are widely used in the field of precision agriculture in various applications like monitoring of crops, threat detection in the field, monitoring of soil conditions, observing the climatic condition near the farming field, etc. Till date, various sensors have been employed in the field of precision agriculture like air humidity and temperature sensors, soil moisture sensors, pressure sensors, gas sensors, soil pH sensors, PIR (Passive Infrared) sensors, etc. Figure 3 demonstrates a few of the several sensors available for use in precision agriculture.

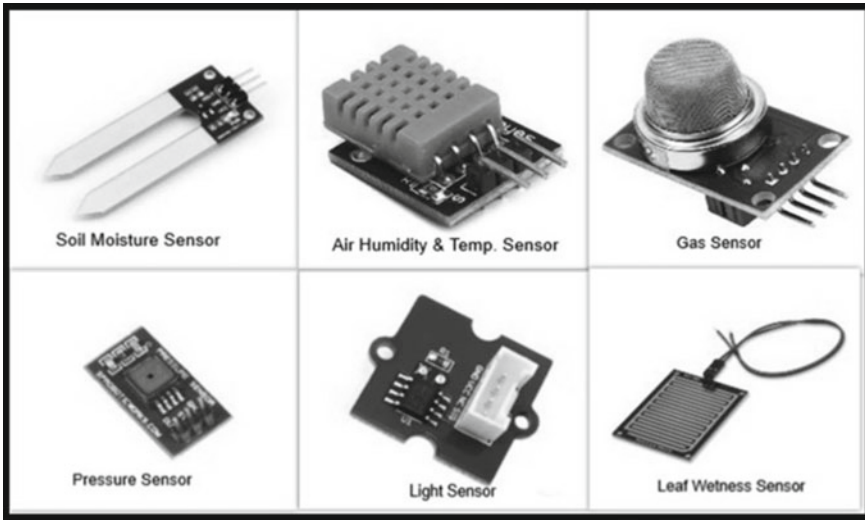

Fig. 3 List of a few sensors used in precision agriculture

5.2 RFID-Based Technology

RFID is an acronym for “Radio-Frequency Identification”. The RFID technology is very much similar to the barcode technology in which digital data from a smart label is captured by a special device and stored into the database. It is basically used for object identification and tracking. The reader present in the RFID tagging system captures the digital data from the RFID tag, attached to the object which has to be identified or tracked. The RFID technology has one main advantage over the barcode technology, that the data of RFID tag can be captured by the reader outside the view of the tag, but in barcode technology, the barcode must be associated with an optical reader for capturing the data. The in-depth integration of RFID technology and Global Positioning System (GPS) can be used for monitoring and controlling the object intelligently. There are various RFID products available in the market, but only a few of them can be used in the precision agriculture applications.

5.3 Wireless Communication Technology

With the rapid increase in the field of information technology, wireless communication technology has also grown gradually. Today, wireless communication has become an essential mode of information exchange among remote users. Wireless communication technologies can be classified into various categories on the basis of the type of devices, range of data and distance of communication. ZigBee, WiFi,

Bluetooth, General Packet Radio Service (GPRS), radio communication, satellite communication, etc. are the most common wireless communication technologies being used currently. ZigBee technology has a monopoly over other communication technologies because of its unique characteristics like low cost, unified standard, less power consumption and versatility. ZigBee, WiFi and GPRS technologies are widely used in the field of precision agriculture because of their cheap and sustainable behavior.

5.4 Automation-Based Technology

Precision agriculture depends on automation based technologies for monitoring and controlling farming related activities. Automation technology is electromechanical in nature; a decision-making framework along with the controller is the main part of the automation technology. Numerous scientists have been working in the field of agriculture automation since the past 8–10 years. Automated irrigation system, crop monitoring system, plant disease detection system, fertilizer and pesticide control system, are some example of agricultural-automation technologies developed by the scientists, mentioned in their research work. These agricultural-automation technologies not only precisely utilize the resources, but also improve the quality of crops and food.

6 Comparative Analysis of Various Techniques

Till date, numerous IoT applications have been proposed in the field of precision agriculture, where automated irrigation system, plant/ crop monitoring system, climate monitoring system, plant disease detection and removal, monitoring and evaluation of soil, fire detection system, weed detection system are the most common applications. A precise and robust architecture is required for the implementation of such applications. Anurag et al. [20] have proposed a wireless sensor network based architecture for precision agriculture applications which senses environmental and meteorological parameters and propagate them to a central repository for further intimation to the farmers and end users. Similarly, Khattab et al. [21] have also developed and implemented a cloud-based three-layered architecture for smart farming applications. Their proposed architecture was intended to collect the required data from the sensing nodes, present on the front-end layer and to propagate it to a gateway layer. Further, the gateway layer propagates the collected data (most probably the manipulated data) to the cloud servers in the back-end layer where this data is stored, processed and analyzed. The required feedback actions that are uncovered from the data analysis and processing are sent back to front-end nodes for the implementation. These types of architectures are the fundamental units for the implementation of any precision agricultural application. Precision agriculture is a science of using

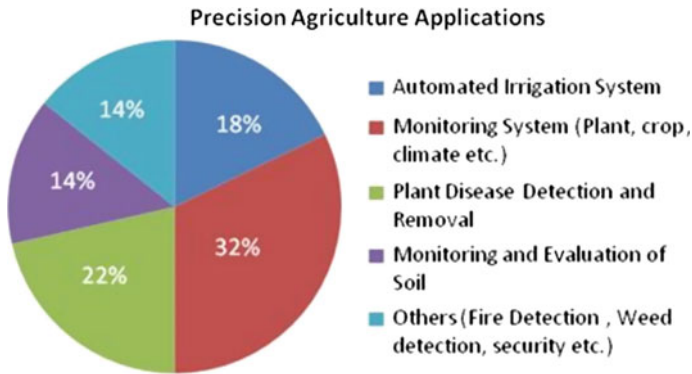

Fig. 4 Distribution as per various precision agriculture applications

IoT technology to improve the production of a farm field. This can be achieved by real-time monitoring and controlling of various agricultural parameters like crops, plants, climatic conditions, etc. We have gone through a number of research papers on IoT applications in the field of precision agriculture and found that 32% of the researchers have focused primarily on monitoring and controlling systems, 18% of them focused on automated irrigation systems, 22% researchers emphasized on plant leaf disease detection and removal, another 14% talked about soil monitoring and evaluation, and remaining 14% focused on emergency systems like fire detection, weed detection, security system etc. in their research papers. Figure 4 depicts the distribution of research papers as per various precision agriculture applications.

Mohanraj et al. [22] have proposed an application named “e-Agriculture” to monitor several meteorological parameters based on a knowledge base. They also provided a mechanism for controlling these parameters in order to increase farm production. Further, a livestock monitoring system has been developed by Tanmay et al. [23], near the field and grain store, without any human intervention. Similarly, [24–29] also used IoT technologies for monitoring various agricultural parameters as crops, plants, climatic conditions, etc. in their research. The main objective of precision farming is the efficient utilization of the agricultural resources like water, pesticides, and fertilizers, etc. To this effect several researchers [22, 30–33] have focused on the proficient utilization of water resources by giving the concept of an automated irrigation system. In precision agriculture, diseases and pests cause excessive monetary loss to farmers by reducing the quality and quantity of crops. Even the pesticides and fertilizers used for controlling these pests and pathogens are very costly, which leads to increased financial pressure on the farmers. So for the detection and removal of plant diseases, many researchers [25, 28, 34–37] have developed various inexpensive and accurate automation techniques, so that they can guide the farmer through providing high security to the farm fields, with minimum cost.

Agricultural productivity is directly and/or indirectly dependent on the soil present in the farm field. Soil improves the growth of plants by mediating the organic, bio-

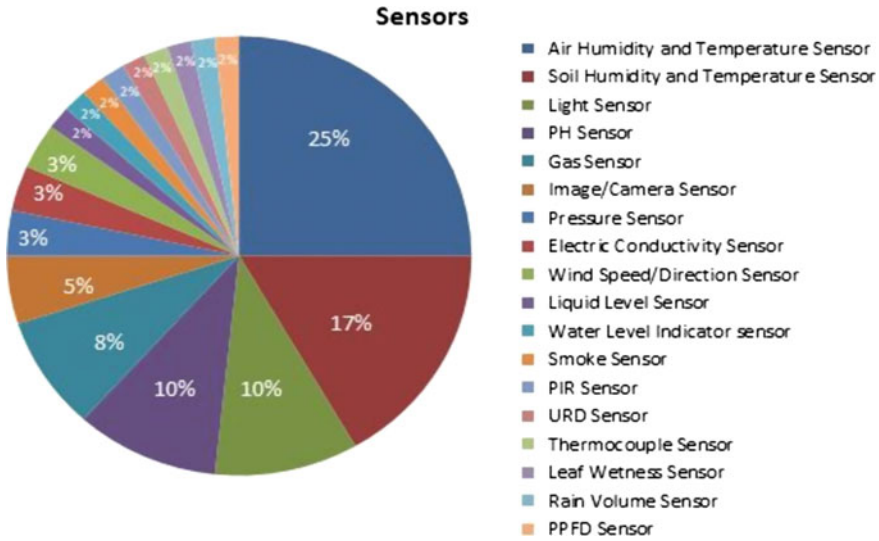

Fig. 5 Distribution as per the type of sensors used

chemical, and physical processes that supply plants with nutrients, water, and other elements. That’s why observation and evaluation of soil is very important for the improvement of agricultural land. Till date, several researchers [22, 30, 34, 38, 39] have focused on the exogenous variables derived from soil monitoring and their subsequent evaluation.

As discussed earlier, there is a multitude of sensors which have been used in the field of precision agriculture like air humidity and temperature sensors, soil moisture sensors, pressure sensors, gas sensors, soil pH sensors, PIR sensors, etc. Figure 5 demonstrates the distribution of research papers on the basis of the type of sensors used in them.

Sensor outputs are basically fed as inputs to the microcontrollers and they represent the electrical equivalent values of any physical quantity. They generally measure physical quantities like light intensity, distance, acceleration, etc., essentially as continuously varying values. So no one can use the sensors without interfacing it with a specific type of microcontroller. There are various microcontrollers available in the market like Raspberry Pi, Arduino, Atmega 128L, etc. Figure 6 shows the distribution of research papers on the basis of types of microcontrollers employed.

Figure 7 shows the distribution of research papers on the basis of sources of data collection. As per our study, we found that 70% of researchers have used sensors for collecting the data. 25% of researchers focused on only images in their research work and 5% of them have used both images and sensors as the data source.

Figure 8 shows the distribution of research papers on the basis of wireless communication technology. As per our study, we found that 45% of researchers have used ZigBee for wireless communication. 25% of them focused on WiFi, RFID tags

Fig. 6 Distribution as per the type of microcontroller

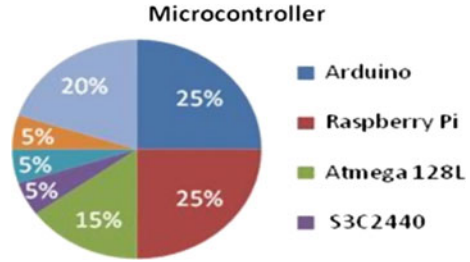

Fig. 7 Distribution as per the sources of data collection

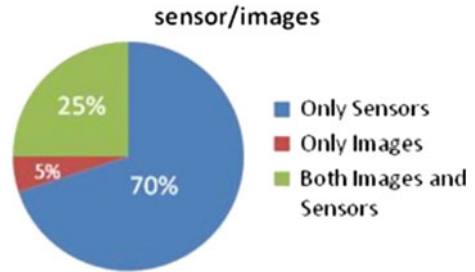
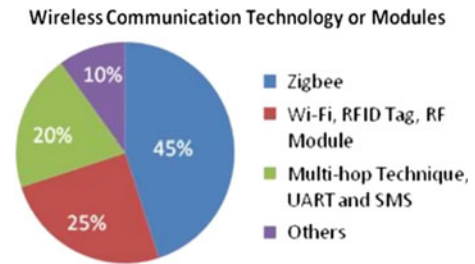

Fig. 8 Distribution as per the used wireless communication technology



and RF module for communication purpose. Another 20% have used UART, SMS, and multi-hop technique for wireless transmission of the data. Remaining 10% have shifted their focus towards some wireless modules like nRF24L01 ultra-low power transceiver wireless communication module. Table 2 lists the names of sensors, applications, communication technologies, etc., employed in the printed literature. Table 3 lists the pros and cons of the wireless communication technologies used in the literature and Table 4 presents a comparison of the most commonly used microcontrollers, as per our study (but not limited to it).

7 Opportunities, Issues, and Challenges

Advanced computational technologies such as machine learning, cloud computing, big data, etc., have brought about a revolution in various fields like healthcare, business, entertainment, and are now being employed to transform the agricultural

Table 2 List of Agriculture applications, sensors and communication modules used

Ref, year	Precision agriculture application(s)	Sensors or images used	Name of sensors	Communication Technology/module	Microcontroller used	Crop/Plant
Reference [34], 2018	<ul style="list-style-type: none"> • Detection of Disease affected plant • Recognition of weeds • Checking the fertility of soil • Fire disaster detection 	Both images and sensor	<ul style="list-style-type: none"> • Soil Moisture Sensor EC-5 • Soil Temperature Sensor THERM 200 • Soil pH Sensor • Soil Electric Conductivity WET-2 • Humidity Sensor STDS75 (STM) • Temperature Sensor • HIH-4000-001 (Honeywell) • Light Intensity Sensor • BH1750FVI(DLI) • Carbon Monoxide Sensor • GGS-200T (UST) • Atmospheric Pressure sensor • MS540B (Intersema) • Smoke Sensor EC01000 (Honeywell) 	Multi-hop technique	-	-

(continued)

Table 2 (continued)

Ref, year	Precision agriculture application(s)	Sensors or images used	Name of sensors	Communication Technology/module	Microcontroller used	Crop/Plant
Reference [35], 2018	Plant Leaf Disease Detection	Images and camera as a sensor	Camera as a sensor	WiFi (inbuilt in Raspberry Pi3 board)	Raspberry Pi3 board	Pomegranate, Brinjal, Tomato
Reference [38], 2018	Soil monitoring system	Sensors	SHT15 Humidity and Temperature sensor	ZigBee, GPRS Module	S3C2440 microcontroller	NA
Reference [32], 2017	Automated irrigation system	Sensors	<ul style="list-style-type: none"> • Temperature and humidity Sensor • Soil Moisture Sensor • Light Intensity Sensor • CO₂ sensor 	ZigBee	-	NA
Reference [25], 2017	<ul style="list-style-type: none"> • Plant Disease Detection • Plant Monitoring 	Both images and sensor	<ul style="list-style-type: none"> • DHT22 Temperature and humidity sensor • MQ-2, MQ-135, MQ-136 Gas sensors • LDR (Light Dependent Resistor Sensor) 	UART communication	Arduino and Raspberry Pi	-

(continued)

Table 2 (continued)

Ref, year	Precision agriculture application(s)	Sensors or images used	Name of sensors	Communication Technology/module	Microcontroller used	Crop/Plant
Reference [37], 2017	Disease Detection and removal	Sensors	<ul style="list-style-type: none"> • DHT11 Humidity and Temperature Sensor • Soil Moisture Sensor • Soil pH value Sensor • Nitrogen Sensor 	ESP8266 WiFi Module	Arduino	Rice crop
Reference [22], 2016	<ul style="list-style-type: none"> • Plant Growth Monitoring • Irrigation schedule planner • Identification of soil type and soil deficiency 	Sensors	<ul style="list-style-type: none"> • DHT11 Temperature and Humidity Sensor • Soil Moisture Sensor (KG003) • Ball Float Liquid level Sensor • Magnetic float sensor (for water level Indicator) • BH1750 Module digital light intensity sensor/ LDR Resistor 	–	T1 CC3200 launch pad and 1.6:8 Arduino Uno board	–
Reference [23], 2016	Monitoring and smart security of the field and grain stores	Sensors	<ul style="list-style-type: none"> • PIR sensor • Web Cameras • URD (Ultrasonic Ranging Device) Sensor 	SMS	Raspberry Pi 2 Model B+	–

(continued)

Table 2 (continued)

Ref, year	Precision agriculture application(s)	Sensors or images used	Name of sensors	Communication Technology/module	Microcontroller used	Crop/Plant
Reference [21], 2016	General cloud-based architecture for precision agriculture applications	Sensors	<ul style="list-style-type: none"> • Air temperature SHT11 • Air Humidity HTU21D • Soil Moisture Sensor SEN0114 • Leaf Wetness FC-37 • Wind Speed/Direction SEN-08942 • Rain Volume Sensor SEN-08942 	nRF24L01 ultra-low power trans-receiver wireless communication module	Raspberry Pi	NA
Reference [31], 2015	Automated irrigation system	Sensors	<ul style="list-style-type: none"> • Soil Moisture Sensor VH400 • Temperature Sensor DS1822 	ZigBee, GPRS Module	PIC24FJ64GB004 Microcontroller	NA
Reference [26], 2015	Monitoring and controlling the connected farm	Sensors	<ul style="list-style-type: none"> • Compound sensor for temperature, humidity, and CO₂ • Photosynthetic photon flux density (PPFD) sensor • Soil Moisture Sensor 	ZigBee	Raspberry Pi	NA

(continued)

Table 2 (continued)

Ref, year	Precision agriculture application(s)	Sensors or images used	Name of sensors	Communication Technology/module	Microcontroller used	Crop/Plant
Reference [27], 2015	Greenhouse monitoring system	Sensors	<ul style="list-style-type: none"> • Temperature Sensor • Pressure Sensor • Light Sensor • Humidity sensor • Wind speed & Wind Direction sensor • CO₂ sensor 	ZigBee	STM85103F3 microcontroller	<ul style="list-style-type: none"> • Carnation Plants • Gerberas Plants • Anthurium plants • Tomato • Roses
Reference [28], 2015	<ul style="list-style-type: none"> • Monitoring climatic parameters for a better quality of plant • Plant leaf disease detection 	Both images and sensor	<ul style="list-style-type: none"> • Temperature Sensor • pH sensor • Humidity sensor • Soil Moisture Sensor 	ZigBee	Arduino 1.0.6	Grape plant
Reference [29], 2015	Monitoring of agricultural parameters	Both images and sensor	<ul style="list-style-type: none"> • Temperature Sensor • pH sensor • Humidity Sensor • Soil Moisture Sensor 	ZigBee	Arduino	NA

(continued)

Table 2 (continued)

Ref, year	Precision agriculture application(s)	Sensors or images used	Name of sensors	Communication Technology/module	Microcontroller used	Crop/Plant
Reference [30], 2013	<ul style="list-style-type: none"> • Soil monitoring • Automated irrigation system 	Sensors	<ul style="list-style-type: none"> • Soil Moisture Sensor (capacitance sensor ECH2O, EC-5 Decagon Devices) • Temperature Sensor (Sensirion Sensors) 	Multi-hop technique	-	Apple tree orchard
Reference [40], 2011	Crop Monitoring and security	Sensors	<ul style="list-style-type: none"> • Soil pH sensor S8000 • Hydra Probe-II sensor (conductivity, salinity, soil moisture and temperature) • MTS-420 Board (ambient light sensor) • EC-10 HS soil moisture sensor • Camera sensor 	ZigBee	Atmega 128L Microcontroller	-
Reference [24], 2011	Crop Monitoring	Both images and sensor	<ul style="list-style-type: none"> • Image Sensor OV7640 • Temperature Sensor • Humidity Sensor 	RF Module CC1101	Atmega 128L Microcontroller	NA

(continued)

Table 2 (continued)

Ref, year	Precision agriculture application(s)	Sensors or images used	Name of sensors	Communication Technology/module	Microcontroller used	Crop/Plant
Reference [33], 2008	Automated irrigation system	Sensors	<ul style="list-style-type: none"> Watermark soil moisture sensor Thermocouple Sensor 	RFID Tag	-	Cotton crop
Reference [20], 2008	General Architecture for precision agriculture applications	Sensors	<ul style="list-style-type: none"> Soil pH Sensor Soil Moisture Sensor Soil Temperature Sensor 	ZigBee	CC2420, Ti (Texas Instruments) bases board	NA
Reference [36], 2006	Plant Disease Detection	Sensors	Sensirion SHT75 Digital Humidity and Temperature sensor	WiFi	Atmega 128L Microcontroller	Potato plants

Table 3 Pros and cons of wireless communication technologies employed

Wireless Communication Technology	General description	Pros	Cons
WiFi	<ul style="list-style-type: none"> • Mostly used to connect various electronic devices with a wireless local area network • Standard—IEEE 802.11 • Uses 2.4 GHz and 5.8 GHz frequency radio bands. • Data Rates—11 to 105 Mbps • Range—10–100 m 	<ul style="list-style-type: none"> • Simple Installation • Inexpensive • Easily Accessible • Scalable 	<ul style="list-style-type: none"> • Highly Vulnerable • Security issues • Restricted Range • The devices working in the same band can interfere
ZigBee	<ul style="list-style-type: none"> • Connect a number of electronic devices with personal area network • Standard—IEEE 802.15.4 • Frequency Bands—868/915 MHz—2.4 GHz • Data Rates—250 Kbps • Range—10–to 300 m 	<ul style="list-style-type: none"> • Less Power Consumption • Nodes can be accessible with small configuration • Support many topologies like One to One, Star, Mesh etc. 	<ul style="list-style-type: none"> • Expensive • Data Rate is low • Frequencies other than 2.4 GHz requires licensing in many countries.
Bluetooth	<ul style="list-style-type: none"> • Used in short distance communication • Standard—IEEE 802.15.1 • Frequency Bands—2.4–2.485 GHz • Data Rates—25 Mbps • Range—0–10 M 	<ul style="list-style-type: none"> • Inexpensive • Less energy utilization • Highly Secure • Low power consumption 	<ul style="list-style-type: none"> • Low Range • Less Data Rates
RFID	<ul style="list-style-type: none"> • Uses electromagnetic field and store information electronically • Used to detect and track the object through tag attached to it • Standard—EPC global standards and ISO RFID standards • Frequency Bands—120 kHz–150 kHz, 13.56 MHz, 433 MHz, 865–868 MHz and 902 to 928 MHz • Data Rates—10–100 Kbps • Range—10 CM–100 M 	<ul style="list-style-type: none"> • Easy Installation • Does not need any power • Highly secure 	<ul style="list-style-type: none"> • Invasive Technology • If tags installed in fluids or metals than RFID reader find difficulty to read them • Incompatible with smartphones

Table 4 Pros and cons of Arduino and Raspberry Pi (microcontroller used)

Microcontroller	Pros	Cons
Arduino	<ul style="list-style-type: none"> • Easier to get started • Best for real-time applications • No need for high programming language • Easy to extend • Comprises of various libraries and contributed shields 	<ul style="list-style-type: none"> • Can only be programmed using C or C++ • Connection to the internet is complex
Raspberry Pi	<ul style="list-style-type: none"> • Easily connects to the internet • Entire Linux software stack available with it • Can be programmed using multiple languages 	<ul style="list-style-type: none"> • No real-time access to hardware • Hardware is not open source • Does not contain inbuilt analog-to-digital converter • Insufficient power to drive inductive loads

domain. With larger investments being poured in this arena, it is evident that there is huge excitement over the potential of these technologies to increase the farm output with minimum input, in terms of land, cost, usage of pesticides, and decreased environmental footprint.

Ease of access to a gamut of electronic devices and social networking sites has resulted in the vast amounts of data being generated by the second. On one hand, the MMBD poses the challenge of storage, processing, transmission, and analysis, and on the other, it presents an opportunity to unfold hidden patterns to be utilized for efficient decision-making. Data being generated is useless unless it is administered in the direction of creating better decision support tools for the stakeholders. MMBD has showcased huge potential towards solving future agricultural problems faced due to growing population and reduced resources. Previously, field related data was collected by the farmers and environmental data was acquired by government agencies. But now, with the slumping costs of sensor-based technologies, much better degree of automation, computational abilities for data generation and data analysis is affordable and evolving day by day. This leads to another challenge, i.e., the heterogeneous and unstructured nature of the acquired data from a plethora of sources. However, this data can be the driving factor for profound advances in plant phenotyping, detection of plant diseases, land cover, soil fertility, study of weather statistics, and deploying farm management systems. Data from multiple growers can be integrated to identify the problem areas and improve the decision-making. Current systems are not equipped with dynamic data aligning and processing capabilities. Another major hindrance is the lack of proper training to the farmers to exercise the data collection equipment and tools, not to mention the lack of sound protocols and policies in place, for consolidation and interpretation of collected data.

One of the principal issues is the privacy of the captured data along with its authenticity. Before moving forward, we need to take into account the measures for validation and verification of the acquired data and the ethical factors as well. Enormous data generated poses the challenge of high dimensionality which hampers the

process of visualization. Along with visualization, we need data integration capabilities for structured, semi-structured and unstructured multimedia data. These are the few likely factors due to which we have not been able to realize the full potential promised by the novel precision agriculture technologies and reap their benefits.

8 Conclusion

This chapter focused on the applications of MMBD and IoT in the field of precision agriculture. In today's scenario, about two-thirds of the data traffic over the internet comprises of multimedia data. Along with the challenges of handling such heterogeneous and voluminous, structured as well as unstructured data, comes the opportunity of analyzing and utilizing it, in order to respond to real-world situations. Current big data systems are not configured to process multiple data types and execute complex image processing and audio/video analytics algorithms. MMBD Computing is one such area that focuses on multimedia data acquisition, storage, to processing and its visualization. One of its major application areas is precision agriculture that requires decision-making abilities to enhance the crop yield and quality, based on the data acquired via an amalgamation of sensors. IoT sensors can be used to create an intelligent system in which various environmental parameters can be observed and acquired to be analyzed. These sensors along with remote sensing technologies accumulate all types of multimedia data, viz., text, audio, images (RGB, multispectral, hyperspectral) and video.

Over the past decade, agricultural applications such as crop monitoring systems and plant disease detection are dominant and on the rise with multiple technologies being implemented for empirical studies. According to our research, mostly used sensors for precision agriculture were Air humidity and temperature sensors, soil humidity and temperature sensors, light sensors and pH sensors. Majority of the researchers have utilized ZigBee as the wireless communication technology because of its low power consumption and cost. Also, Arduino and Raspberry Pi are the most commonly used microcontrollers with multifaceted applications in smart farming. There has been a huge increase in the use of advanced technologies to precision agriculture for quantifying the shortcomings related to data collection and analysis. While there are numerous concerns, such as reliability, cost, security, deficient procedures, etc., it is expected that in future, with new designs in advanced remote sensing technologies and relevant protocols in place, there will be greater benefits for precision agriculture and its subsequent impact on the ecosystem.

9 Future Direction

In the near future, the agricultural domain will come face to face with several challenges such as water shortage, reduced soil fertility, weeds, use of fertilizers and

their negative impact on the environment and human health, growing population, increased cost of seeds, chemicals, etc. Use of advanced computational technologies can heighten the decision-making capabilities and reduce the wastage of resources. The CPS-based agricultural systems can be equipped with advanced functionalities such as tracking capabilities, dynamic data aggregation, multimedia content analysis, data mining methods, detection of faulty sensors, generating yield maps for the field, daily task manager, notifications to be sent to the grower along with suggestions, updates to be sent periodically, remote control of agricultural devices etc. Work needs to be done to make the existing methods reach the farmers effectively, to be user-friendly, secure, and accurate.

References

1. A. Kumari, S. Tanwar, S. Tyagi, N. Kumar, M. Maasberg, K.K.R. Choo, Multimedia big data computing and Internet of things applications: a taxonomy and process model. *J. Netw. Comput. Appl.* **124**, 169–195 (2018)
2. T. Iizumi, N. Ramankutty, How do weather and climate influence cropping area and intensity? *Global Food Secur.* **4**, 46–50 (2015)
3. Z. Wang, S. Mao, L. Yang, P. Tang, A survey of multimedia big data. *China Commun.* **15**(1), 155–176 (2018)
4. J. Vora, P. Italiya, S. Tanwar, S. Tyagi, N. Kumar, M.S. Obaidat, K.F. Hsiao, Ensuring privacy and security in E-Health records, in *2018 International Conference on Computer, Information and Telecommunication Systems (CITS)* (IEEE, 2018) pp. 192–196
5. J. Vora, P. DevMurari, S. Tanwar, S. Tyagi, N. Kumar, M.S. Obaidat, Blind signatures based secured E-Healthcare system, in *2018 International Conference on Computer, Information and Telecommunication Systems (CITS)* (IEEE, 2018) pp. 177–181
6. S. Tanwar, M.S. Obaidat, S. Tyagi, N. Kumar, Online signature-based biometric recognition, in *Biometric-Based Physical and Cybersecurity Systems* (Springer, Cham, 2018) pp. 255–285
7. S. Tanwar, S. Tyagi, N. Kumar, M.S. Obaidat, Ethical, legal, and social implications of biometric technologies, in *Biometric-Based Physical and Cybersecurity Systems* (Springer, Cham, 2018) pp. 535–569
8. S. Pouyanfar, Y. Yang, S.C. Chen, M.L. Shyu, S.S. Iyengar, Multimedia big data analytics: a survey. *ACM Comput. Surv. (CSUR)* **51**(1), 10 (2018)
9. Food and Agriculture Organization of the United Nations. <http://www.fao.org>
10. Y. Liu, Y. Peng, B. Wang, S. Yao, Z. Liu, Review on cyber-physical systems. *IEEE/CAA J. Autom. Sin.* **4**(1), 27–40 (2017)
11. S. Verma, A. Chug, A.P. Singh, Prediction models for identification and diagnosis of tomato plant diseases, in *Advances in Computing, Communications and Informatics (ICACCI), 2018 International Conference* (IEEE, 2018), pp. 1557–1563
12. C.R. Rad, O. Hancu, I.A. Takacs, G. Olteanu, Smart monitoring of potato crop: a cyber-physical system architecture model in the field of precision agriculture. *Agric. Agric. Sci. Proced.* **6**, 73–79 (2015)
13. R. Fresco, G. Ferrari, Enhancing precision agriculture by internet of things and cyber physical systems. *Atti Soc. Tosc. Sci. Nat. Mem. Supplemento* **125**, 53–60, (2018)
14. A. Kumari, S. Tanwar, S. Tyagi, N. Kumar, Fog computing for healthcare 4.0 environment: opportunities and challenges. *Comput. Electr. Eng.* **72**, 1–13 (2018)
15. S.S. Gill, I. Chana, R. Buyya, IoT based agriculture as a cloud and big data service: the beginning of digital India. *J. Organ. End User Comput. (JOEUC)* **29**(4), 1–23 (2017)

16. L. Tan, Cloud-based decision support and automation for precision agriculture in orchards. *IFAC-PapersOnLine* **49**(16), 330–335 (2016)
17. X. Pham, M. Stack, How data analytics is transforming agriculture. *Bus. Horiz.* **61**(1), 125–133 (2018)
18. M. Carolan, Publicising food: big data, precision agriculture, and co-experimental techniques of addition. *Sociol. Ruralis* **57**(2), 135–154 (2017)
19. S. Tanwar, P. Patel, K. Patel, S. Tyagi, N. Kumar, M.S. Obaidat, An advanced internet of thing based security alert system for smart home, in *Computer, Information and Telecommunication Systems (CITS), 2017 International Conference on* (IEEE, 2017) pp. 25–29
20. D. Anurag, S. Roy, S. Bandyopadhyay, Agro-sense: Precision agriculture using sensor-based wireless mesh networks, in *First ITU-T Kaleidoscope Academic Conference-Innovations in NGN: Future Network and Services*, (IEEE 2008) pp. 383–388
21. A. Khattab, A. Abdelgawad, K. Yelmarthi, Design and implementation of a cloud-based IoT scheme for precision agriculture, in *Microelectronics (ICM), 28th International Conference*, (IEEE 2016) pp. 201–204
22. I. Mohanraj, K. Ashokumar, J. Naren, Field monitoring and automation using IOT in agriculture domain. *Procedia Comput. Sci.* **93**, 931–939 (2016)
23. T. Baranwal, P.K. Pateriya, Development of IoT based smart security and monitoring devices for agriculture, in *Cloud System and Big Data Engineering (Confluence), 6th International Conference* (IEEE 2016), pp. 597–602
24. Z. Liqiang, Y. Shouyi, L. Leibo, Z. Zhen, W. Shaojun, A crop monitoring system based on wireless sensor network. *Procedia Environ. Sci.* **11**, 558–565 (2011)
25. B. Patil, M.H. Panchal, M.S. Yadav, M.A. Singh, M.D. Patil, Plant Monitoring using image processing, raspberry Pi & Iot, in *International Research Journal of Engineering and Technology (IRJET)*, pp. 1337–1342 (2017)
26. M. Ryu, J. Yun, T. Miao, I.Y. Ahn, S.C. Choi, J. Kim, Design and implementation of a connected farm for smart farming system, in *Sensors*, IEEE (IEEE 2015), pp. 1–4
27. L.I.U. Dan, C. Xin, H. Chongwei, J. Liangliang, Intelligent agriculture greenhouse environment monitoring system based on IOT technology, in *Intelligent Transportation, Big Data and Smart City (ICITBS), 2015 International Conference* (IEEE, 2015), pp. 487–490
28. G.H. Agrawal, S.G. Galande, R. Shalaka, Leaf disease detection and climatic parameter monitoring of plants using IoT. *Int. J. Innov. Res. Sci. Eng. Technol.*, 9927–9932 (2015)
29. S.G. Galande, G.H. Agrawal, M.L.S. Rohan, Internet of things implementation for wireless monitoring of agricultural parameters, in *International Journal of Advanced Research in Electronics and Communication Engineering (IJARECE)*, pp. 2121–2124. (2015)
30. B. Majone, F. Viani, E. Filippi, A. Bellin, A. Massa, G. Toller, M. Salucci, Wireless sensor network deployment for monitoring soil moisture dynamics at the field scale. *Procedia Environ. Sci.* **19**, 426–435 (2013)
31. J. Gutiérrez, J.F. Villa-Medina, A. Nieto-Garibay, M.Á. Porta-Gándara, Automated irrigation system using a wireless sensor network and GPRS module. *IEEE Trans. Instrum. Meas.* **63**(1), 166–176 (2015)
32. B. Zhou, L. Li, Security monitoring for intelligent water-saving precision irrigation system using cloud services in multimedia context. *Multimed. Tools Appl.*, 1–15. (2017)
33. G. Vellidis, M. Tucker, C. Perry, C. Kvien, C. Bednarz, A real-time wireless smart sensor array for scheduling irrigation. *Comput. Electr. Agric.* **61**(1), 44–50 (2008)
34. K.N. Bhanu, T.B. Reddy, M. Hanumanthappa, Multi-agent based context aware information gathering for agriculture using wireless multimedia sensor networks. *Egypt. Inform. J.* (2018)
35. S.A. Nandhini, R. Hemalatha, S. Radha, K. Indumathi, Web enabled plant disease detection system for agricultural applications using WMSN. *Wirel. Pers. Commun.* **102**(2), 725–740 (2018)
36. K. Langendoen, A. Baggio, O. Visser, Murphy loves potatoes: experiences from a pilot sensor network deployment in precision agriculture, in *Parallel and Distributed Processing Symposium, 2006. IPDPS 2006. 20th International* (IEEE, 2006) p. 8

37. T.S.T. Bhavani, S. Begum, Agriculture productivity enhancement system using IOT. *Int. J. Theor. Appl. Mech.* **12**(3), 543–554 (2017)
38. G.V. Satyanarayana, S.D. Mazaruddin, Wireless sensor based remote monitoring system for agriculture using ZigBee and GPS. *Conf. Adv. Commun. Control Syst.* **3**, 237–241 (2013)
39. S. Tyagi, M.S. Obaidat, S. Tanwar, N. Kumar, M. Lal, Sensor cloud based measurement to management system for precise irrigation, in *GLOBECOM 2017–2017 IEEE Global Communications Conference* (IEEE, 2017), pp. 1–6
40. A.J. Garcia-Sanchez, F. Garcia-Sanchez, J. Garcia-Haro, Wireless sensor network deployment for integrating video-surveillance and data-monitoring in precision agriculture over distributed crops. *Comput. Electr. Agric.* **75**(2), 288–303 (2011)

Applications of Machine Learning in Improving Learning Environment



Pallavi Asthana and Bramah Hazela

Abstract Machine learning are having a tremendous impact on the teaching industry. Teaching industry is adopting new technologies to predict the future of education system. It is Machine learning which predict the future nature of education environment by adapting new advanced intelligent technologies. This work explores the application of Machine Learning in teaching and learning for further improvement in the learning environment in higher education. We explore the application of machine learning in customized teaching and learning environment and explore further directions for research. Customized teaching and learning consider student background, individual student aptitude, learning speed and response of each student. This customized teaching and learning approach provide feedback to teacher after real-time processing of the data. This way a teacher can easily recognize student attention and take corrective measures. This will improve student participation and hence the overall results. Individual student concepts and goals can easily be track with the help of Machine learning by taking real-time feedback. Based on that feedback, curriculum, topics and methodology can be improved further. In simple terms, machine learning makes the process automatic for decision making process and analyzed the individual student data. Overall, the assessment process is made more streamlined, accurate and unbiased with the help of machine learning. In the near future, machine learning will be more efficient and produce even better results.

Finally, Machine learning will help educators to make our teaching and learning environment more fun and challenging with the aid of intelligent technologies and take

P. Asthana

Department of Electronics and Communication Engineering, Amity School of Engineering and Technology, Amity University Lucknow, Lucknow, India
e-mail: pallaviasthana2009@gmail.com

B. Hazela (✉)

Department of Computer Science and Engineering, Amity School of Engineering and Technology, Amity University Lucknow, Lucknow, India
e-mail: bramahazela77@gmail.com

our education to new heights, as soon as education system implement the machine learning concept in their curriculums.

Machine learning can potentially redefine not only how education is delivered, but also foster quality learning on the students' part. Probably the most important part of the role of machine learning in teaching is customized teaching. With machine learning, we are moving away from the one-size-fits-all methodology. Machine learning promises to deliver custom in-class teaching by providing real-time feedback based on individual student behavior and other factors. This improves the chances of better learning. Machine learning also plays an important role in assessments or evaluations by removing biases. Customized teaching is the direct opposite of the one-size-fits-all methodology or philosophy. It considers individual student aptitude, learning speed, background, response and other variables. It processes the data in real time and provides feedback to the teacher, so that the teacher can recognize flagging student attention or poor response immediately and take corrective actions. This can potentially improve student participation and, in the process, the overall results. Machine learning will be able to explain the concepts as well as set the goals for individual students. On the other hand, teachers will be able to track whether or not the students are able to digest the concepts. Based on that feedback, educators can change or modify the methodology, curriculum or topics accordingly. And, the result is more accurate and targeted for individuals. In simple terms, machine learning does the analytics based on individual student data, and makes the decision-making process automatic and uniform. Assessment is a major part of the teaching and learning process. Machine learning technology can help teachers assess or evaluate tests objectively and provide feedback. Machine learning applications can do the assessment and provide scores. The process is taken care of by the machines, removing human intervention and helping to remove human prejudice or bias from the process.

However, at the same time, we need to remember that the assessment is done by machine learning algorithms, based on the data feed. Therefore, some human intervention might be required on a case-to-case basis. For example, occasions such as research paper evaluation, interactive work, oral examination, etc., some human intervention is still necessary. Overall, the assessment process is made more streamlined, accurate and unbiased with the help of machine learning.

To date, lesson plans have been made in a generic way, so they are the same plan for all the students. However, students have different types of learning ability, so the same lesson plan may not be ideal for all students. Imagine a scenario where a student is able to learn quickly through visual representations/figures/diagrams, but he/she is given text-based study material—the student may struggle with learning the material. Before AI and machine learning, there wasn't a practical way to detect this and find a possible solution. As a result, it imposes a tremendous amount of pressure on the student and sometimes leads to failure, although the student might have had a good potential. If the material had only been presented differently, the student may have easily understood and learned it.

AI applications are a great solution to this situation. Custom lesson plans can potentially result in better learning because the technology can assess student data

and determine the best methods in which students can learn. It will also determine a better mapping of subjects based on student interest.

Feedback is an important part of any learning system. In teaching as well, feedback is one of the most important components. When we talk about feedback, it means 360-degree feedback. Here, it is applied to both student and teacher. Machine learning analyzes the student data (grading, interest, score, behavior, etc.) and provides feedback. Machine learning also analyzes teachers' data (subject taught, method of teaching, acceptance, etc.) and prepares feedback. This feedback helps both parties. Students are able to get constructive feedback and act accordingly to get better results. On the other hand, teachers are able to adjust themselves to provide a better teaching experience. While the teacher does already provide student feedback, machine learning will go further and deeper. It will assess student behavior, responses and historical data, and arrive at data-based conclusions and provide objective feedback. As for assessments, it will eliminate the possibility of human prejudice while providing feedback.

Career Prediction is one area where students can get confused and make a decision that may not work out for the best. The career path of a student is very important for their future. If the path is not chosen with care, frustration and disappointment can be the result. In general, the decision for a student's career path can be greatly influenced by a number of factors, including the family profession, parents and neighbors—and, of course, the most lucrative careers options. However, the most important thing is missing: the interest of the individual student. AI and machine learning can play a major role here. Machine learning applications for career path prediction are able to track student interest, aptitudes and dislikes. It analyzes student behavior and reactions. Based on the analysis, it can fairly predict interest areas in which the student can excel. (For more on cutting-edge education, see *Education Must Turn to the Cloud.*)

Artificial intelligence and machine learning are having a tremendous impact on the teaching industry. Before the introduction of AI/machine learning, a generic, one-size-fits-all type of approach was commonly used. As a result, students were forced to try to adjust their style of learning to the lesson plan, rather than the other way around. On the other hand, educators were facing a lot of trouble, trying to understand the students' needs and the possible solutions. So, the teaching experience and the success rate was not as per expectation. With the advent of machine learning and AI, it is becoming more focused, accurate and successful. Machine learning, if harnessed, can revolutionize teaching just based on data. In the near future, machine learning will be more efficient and produce even better results.

1 Machine Learning in Education

Tools developed with Machine Learning and Artificial Intelligence can be useful to enhance teaching capabilities. It can work independent of teachers and can be useful to support teachers [1]. Main areas utilizing these applications are [2]:

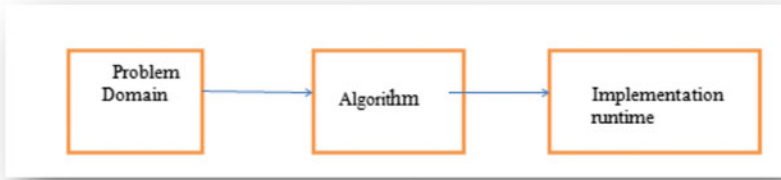

Fig. 1 Testing of software

- (i) **Tutoring:** Intelligent tutoring systems are the adaptive tutoring systems that are capable of engaging students in dialogues, answering them and they can also provide feedback.
- (ii) **Customized Learning:** Adaptive tutoring systems can be customized as requirement of students in terms of learning material, sequence of the learning, material and understanding of different students in different topics. It is also useful for the students with special needs in enabling them to identify facial expressions.
- (iii) **Automated Assessment:** Automated are highly efficient to evaluate the understanding level of the students as these systems are able to adjust the difficulty level of successive questions based on past performance.
- (iv) **Teachers Support:** Machine learning algorithms could be utilized to perform routine task of taking attendance, evaluating assignments and to generate the questions. This is helpful for the teachers.

Machine Learning in Testing of the Educational Software: Educational software are required to be very precise as they impact upon the learning process of students. They are also utilized for the assessment and tutoring of the students. Hence, they are required to undergo intensive testing process before implementation. Software testing is validates the alignment of a software with attributes of the system and also verifies that it is able to meet the intended goals. With the increase in the complexity of the software, testing process becomes more intensive [3]. Metrics and specification of software, Control flow graph, call graph execution data, test case failure report and coverage data are elements of learning. Testing of the software includes the following steps:

- (i) Analysis of problem domain and its corresponding data sets.
- (ii) Analysis of the algorithm.
- (iii) Analysis of the implementation runtime options.

Automated testing process is used to reduce the cost of testing and time required in the testing. Various Machine learning algorithms Artificial Neural Networks, Decision trees, Genetic algorithms, Bayesian learning, Instance base learning, Clustering etc. are used in the testing of the software. These methods also enhance the performance in the testing [4] (Fig. 1).

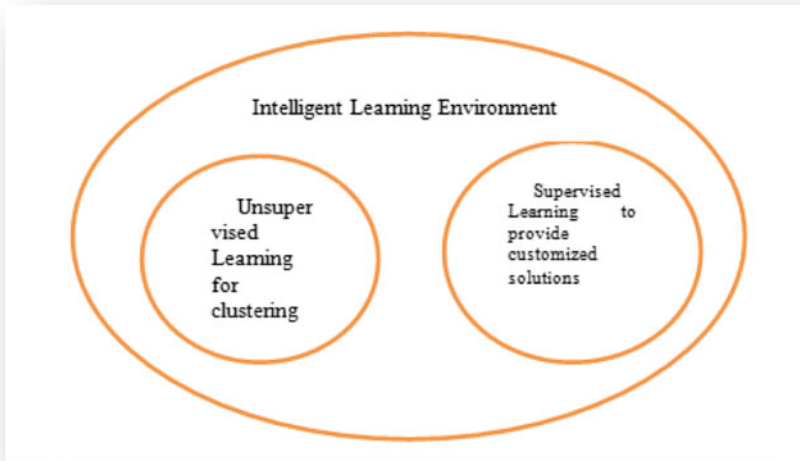

Fig. 2 Intelligent learning environment utilizing both supervised and unsupervised learning

Machine Learning in Intelligent Learning Environment: Intelligent Learning environment are referred to the systems that utilize both Supervised and Unsupervised learning. This is highly useful to represent the learning of the students in traits like knowledge, meta-cognitive abilities and learning behaviour to predict the future behavior of student. These systems are generally based on statistical pattern recognition [5]. These patterns are achieved by data acquisition, processing, learning and testing. This can be done through manually labeling of data and then applying supervised learning algorithms to identify behavior. To reduce the implementation time can be further achieved by using Unsupervised learning algorithms like k means clustering to identify common learning behavior and supervised learning is implemented to actually build the user model from the identified patterns. Intelligent learning environment provides tools to support the exploration of student in certain subject and adaptive models can provide customized suggestions to improve the exploration of students (Fig. 2).

Machine Learning for Career Prediction and Career Planning: This appears to be an interesting application of Machine learning for the career prediction and career planning.

- (i) **Career Prediction:** Career Prediction is based on the activity of individuals on various social websites. This is achieved by multi-view multi-task learning. It provides both feature heterogeneity and task heterogeneity both. Thus it is more suitable for complex problem like career prediction. This type of learning mainly uses the graph based approach. Multi view learning makes use of the consistency among different views to achieve the better performance as information from multiple social sites of the same user can reveal their characteristics

from different views and Multitask learning can model the tasks that are related to each other. In general, it has been found that features that are extracted from multiple sources are in high dimension and sometimes this information is highly sparse in nature. LASSO regression analysis is used to control sparsity and to identify task- sharing and task specific features that are crucial in determining the influential factors that have a effect on the career progression of specific User [6].

- (ii) **Career Planning:** For the career planning, data related to the qualification, present and past experience of the user is collected and based on the given profile, best career option is presented to the user [7]. To create this model, k-means clustering is done to identify the users with similar backgrounds and then Markov's chain model is used to estimate transition probability matrix. It makes an assumption that next state depends on present state. Log likelihood method is used to extract the goals with maximum probability from transition probability matrix and Langrangian is helpful while optimizing the results. Shortest path based on these optimized results is calculated by Dijkstra's Algorithm. Model is able to guide the user for career planning by suggesting the most appropriate career path. If a person wants to join as a Director in a financial firm, then model will guide him to obtain a degree in finance and then follow a complete path through joining as a assistant manager, Manager and then reaching the position of manager. This is a drawback of this system that it works in small steps. So, cannot provide the solution based on other factors like expertise of person, their reputation etc.

Machine Learning in Automated Assessment: Assessment is a powerful learning tool that can enhance learning and education. The process of student assessment should align with curricular goals and educational objectives. Identifying the assessment strategies necessary for the proper evaluation of students' progress within individual programs is as important as establishing curricular content and delivery methods. The purpose of this paper is to discuss elements to be considered in assessment design and implementation as well as common challenges encountered during this process. Elements to be considered during assessment design include purpose of assessment, domains to be tested, and characteristics of the assessment tools to be employed. Assessment tools are evaluated according to four main characteristics: relevance, feasibility, validity, and reliability. Based on the evidence presented in the literature, the use of a variety of assessment tools is recommended to match diverse domains and learning styles. The assessment cycle concludes with the evaluation of the results and, based on these, the institution, program, or course can make changes to improve the quality of education. If assessment design aligns with educational outcomes and instructional methods, it improves the quality of education and supports student learning.

Assessment methods are the strategies, techniques, tools and instruments that are developed with heuristic for collecting information to determine the extent to which students demonstrate desired learning outcomes. Machine learning has been

variedly employed to generate the questions and also in evaluation [8]. Different types of machine learning applications utilised for the automated assessment are:

- (a) **Neural Network:** These are the layered network. They have input layer, hidden layers and output layers [9, 10]. For the assessment, weights are allocated to each questions and on the basis of the correctness of the answer, difficulty level of the next question is adjusted.
 - (i) **Long Short Term Memory:** These are specific types of recurrent neural networks that are able to model temporal sequence [11]. They are also able to accurately model long range dependencies. These are reward based systems and show fast response [12].
 - (ii) **Convolutional Neural Network:** Convolutional Neural Networks are more sophisticated version of the ANN. They are the class of deep feed forward Artificial Neural Networks. In artificial neural networks, each neuron is connected with neuron of the next layer whereas in CNN, only spatially similar neurons are connected to neurons of next layer it means they are grouped on the basis of their functionalities. This makes use of the process of feature extraction and feature map to reduce the number of free parameter [13]. CNN reduces the task of learning for all neurons and enhances the efficiency of the systems. This method is more useful in the systems that have more images so pattern recognition is done efficiently. In the assessment of subject, same words can be repeatedly used and most of the words are related so, this is quite useful in assessment [14].
 - (iii) **Deep Reinforcement Learning:** Deep Learning is useful in question setting of the difficulty level of the next question in the automated assessment. This supports a flexible environment with high dimensional state and action spaces. These algorithms are capable of altering their own consequence of actions on the basis of interaction and rewards. It works on the paradigm of trial and error [15].
- (b) **Natural Language Processing:** Natural Language processing has been used for the generation of multiple choice questions where labels are extracted from given sentence. These labels are extracted from Semantic Role labeler [16]. Informative sentences are selected to find key and distractors. NLP can categorize each word into its part of speech through the series of coded rules of Grammar. These grammar rules rely on the algorithms that are based on statistical rules Maximum Likelihood estimators, Methods of parametric estimation, Non-parametric distribution, Standard distribution, Binomial distribution, Multinomial and standard distributions. Semantic analysis and is achieved by various methods like Context free Grammar etc. [17]
Informative sentences, key and distractors are found with the Syntactic and lexical features. With the help of all these entities, similarity between the question is determined through all the existing knowledge in database (Fig. 3).
- (c) **Fuzzy Logic:** Fuzzy logic is popular in many applications now because of it reasoning and computation capabilities. Systems that utilize fuzzy logic are

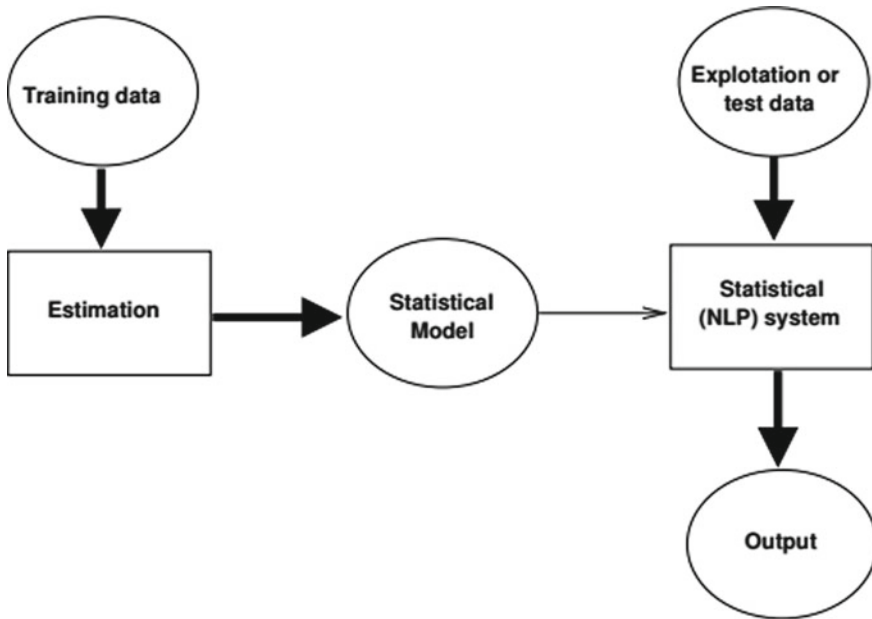

Fig. 3 Natural language processing based system [17]

good in approximate and precise, both type of reasoning. This ability of these system has been exploited in setting of the question paper as the framing of a question paper counts a number of parameters [18]. These parameters includes difficulty level, numerical and theoretical content, weightage of the marks for particular questions etc.

For some subjects like literature, behavior sciences etc., fuzzy logic is used for setting of question paper. In fuzzy logic, membership function is defined and output is chosen on its basis. Fuzzy mathematics makes use of set theory.

- (d) **Genetic Algorithm:** Genetic Algorithms are good at taking large, potentially huge search spaces and navigating them, looking for optimal combinations of things. Genetic Algorithm is able to provide a specific solution that has been designed in order to determine the difficulty level of open questions in an automatic and objective way. In the context of Outcome based education, questions can be matched and validated with the specifications that are already defined with the course [19]. Auto generated systems are good in setting up of difficulty level of questions. Genetic Algorithms are a part of evolutionary algorithms and they are categorized as global search heuristic. They are inspired by process of evolution such as inheritance, selection, mutation and crossover(recombination). These algorithms are implemented in computer simulation where various solutions are optimized towards better solutions. This is achieved by initially evaluating the fitness function of each candidate (solution) in the population (set of possible solutions)and modifying them through recombination and mutation

to form new population. Algorithms will keep on iterating until the optimized result is achieved based on the fitness function [20].

Apart from these techniques combination of various technique is also used to design automated assessment systems like combination of PCA with NLP or SVM with NLP, Neural network with fuzzy system or genetic algorithm with fuzzy system. Development of multiple choice questionnaires using the adaptive graph has also been developed recently [21, 22].

2 Machine Learning in Virtual Learning

Over 78% of Virtual learning systems that has been developed are being utilized in the Education sector. Machine learning can analyze and extract data, to find correlation and patterns from large data sets to make useful information. Various techniques that are used in creating Virtual learning environment are Neural networks that are a network of highly connected nodes that work collectively to provide solution, Support Vector Machine (SVM) are useful to classify the data to provide the best solution space, Decision trees create a pictures of decision to determine a strategy for finding best suitable path that reaches to solution, Fuzzy logic is good in reasoning and comprehending the possible set. Others algorithms that are utilized to create Virtual learning system are Roulette wheel Algorithms that maximize the choice of learning path and evolutionary algorithms provides the optimal paths in data and processes similar to the behavior of living organisms like ants, swarms etc [23].

It has become important explore these techniques as in Virtual learning system consist of a very large amount of Data that remains available to be captured and exploitation. Multi-dimensional analysis is required due to the increasing complexity and interdependence of large number of data classes and attributes.

Various techniques that have been developed for research and development in the education System are grouped like Adaptive Learning Systems, Intelligent Tutor Systems, Cognitive Systems and recommender Systems.

Machine Learning to Predict Learning Outcomes: Machine learning can be utilized to predict the learning outcomes of the students. This system is useful to improve the dropout rate of the students by early intervention. System are accurate, sensitive and specific in terms of utilizing Machine learning algorithms to predict the performance of the students on early stages of training [24]. They mainly complete the following tasks:

- (i) Automatic collection of exam scores
- (ii) Data available on the exam scores

Unobservable variables are then find out based on this data like pre-knowledge, talent and diligence of the student. On the basis of this information predictive model is created to predict the Learning outcomes of students.

3 Machine Learning in Agent-Based Educational Applications

In the era of Artificial intelligence, Machine Learning facilitate customized teaching and learning process to improve efficiency of educational application. Efficiency and effectiveness of the education system can be improve by Dynamic adaptive learning and teaching strategies. In current pedagogical systems only few learning systems exist which are dynamic and able to satisfy individual students need. Availability of these systems needs to be increase by incorporation of agents and learning objects in educational applications. Such intelligent learning systems must be adaptive, able to learn and dynamic [25]. Many educational technology are projects available as either stand-alone learning systems or Web based learning tools. All these projects involve the use of techniques such as multimedia interaction, learning models and asynchronous learning. Required integrated approach has been given for the architectural design of pedagogic information [26].

An agent-based educational architecture system defines the key functions for dynamic and adaptive learning system. To address the challenges of modern education system agent-based technology is being used to provide dynamic adapting learning [27]. Various types of agent types frameworks are:

- (i) **Simulation Based Study**—Simulation is done by the application of Machine Learning to analyze the architecture of Agent-based system. This analysis enables the approach to be student centered and handle individual students' requirements. This also improve the dynamic adaptivity in education systems. Learning adaptability at conceptual level can also be achieved by combining the learning theory with agent-based systems. This analysis is based on the presentation of learning objects to individual students using multi-disciplinary approach. Practical level adaptivity is achieved through multi-agent system. This system uses a pre-built knowledge to determine the learning objects and learning styles that are appropriate for the need of individual students.
- (ii) **An Agent-Based Distributed Framework**—This framework uses machine learning and data mining. It enables agents to exchange local learning processes model and integration of processes among different number of methods. Individual learning processes model among agents is supported by exchange of meta-level descriptions which ensure online reasoning about learning progress and learning success by learning agents. The mechanism of interaction among agent allows to apply to distribute various tasks of machine learning. It requires a powerful coordination among agents available in agent-based computing. Learning decisions with in agents enables agents to engage in *meta-reasoning process*. Conceptual frameworks are used in applications where different learner uses different data sets to implement the architecture of Modern real world distributed clustering.
- (iii) **Agent-Based Computational Economics (ACE)**—Analysis of non-linear processes and representation of such system is based on the computer simulation method of Agent-based Computational Economics. Agents and learning

processes of ACE models are represented through artificial intelligence and methods of machine learning. These systems are developed by reinforcement learning framework that are realized in Simulation system. They are able to illustrate the features of learning framework and to analyze the non-linearity of the agent-based modeling.

4 Machine Learning in Education Data Mining

Educational Data Mining is concerned with the data which comes from educational setup that is related with the improvement in the teaching learning processes by developing various methods. Educational Data mining can be categorized as: statics and visualization of Data, Web mining and Text mining. Educational data mining is done to predict, classify, regression, estimation of density and clustering. Various types of techniques are used to implement these goals like relationship mining, association mining, correlation mining, sequential mining etc.

Data is collected from varied sources including the learning of individual from software used for education purposes, collaborative learning supported by computer, and various automatic testing. Main aim of all the analysis is to improve upon students models. These models represent the information about students in terms of their current knowledge, level of motivation and cognitive skills as these factors are associated with performance of the students with the help of educational data mining methods. It is interesting to know that with the help of various models developed with the help of data mining tools, it is possible to find about real-time monitoring of students as when they are gaming on system or when they are experiencing poor efficacy or getting bored or frustrated. With the help of these models, it is possible to predict the student's retention, non-retention or failure in different courses taught at college as these model represents information about student's characteristics or attitude.

Space searching algorithms from Machine learning have been applied for the developing automated approaches to make accurate domain structure models from the data itself. Methods like making q matrix based on the responses of the students and feedback from students [28]. Skills labels from different item types can be assigned to different items by utilizing the method of covariance. It helps in identifying the role of various skills in learning of the complete domain. Partial order knowledge structures are being used to analyze relation between statistical tools like covariance for outcome relationship in item type. Relationship between item type and duration are found by Pearson correlation.

Educational Data mining is also being used to find out the student-pedagogical relations. It is able to find as which types of pedagogy will be effective for a group of students or individual in various situations. Hence, it has application in the collaborative learning also. This can be achieved by using learning decomposition methods. Data pertaining to performance of the students in varying pedagogies is plotted on a curve mostly the success of student. Best fitted model is created based on the curve

and weights relative to each of the pedagogy in the model is supportive to select the suitable pedagogy for learning.

Another application of Educational Data Mining is to refine and extend the understanding of educational theories and phenomenon for better understandings and improvement in it. Education at different levels is required to be taught in different ways and to extract the information in various situation related with the performance of the students is highly important. In an educational system, it becomes essential to monitor student's behavior and improvement in academic performance.

5 Machine Learning in Education Science for Educational Research

Earlier research related to education was mostly limited to the students studying in any course, area or Institute. So the data related with the educational research was limited. Statistical tools used to analyze these amount of data were not sufficient o model the parameters is received from this huge amount of data number in millions of students through Massive open online courses.

Various Machine learning have greater potential for the analysis of large data sets that are generated through the Massive Open Online courses. Data sets of these courses is also varying in nature due to high diversity in the backgrounds of the students, their conceptual knowledge, their demographic location etc. Many data Scientist are collecting data from these sites and this data is utilized by educational researchers and scientist for analysis [29].

Machine learning based data-driven predictive models provide support in forming and testing of the hypothesis for problems associated with these huge data sets (Fig. 4).

To analyze the deeper context of the data, hypothesis is set and is based on the questionnaire, independence of the course with respect to structure of the course and course content is found for example, if we want to analyze Java programming and C++, then, its basic structure is same, but course content is different, still, they both object oriented programming. If the same course is taught by different teachers, then mode of delivery may be different.

Information extracted from questionnaire, is processed and part of the information that supports the hypothesis is used to create Predictive models. In an Online system, data is collected on the various aspects like number of students registered for course, lecture view, lecture review, submission of the quiz based on video (lecture), resubmission of quiz, completion of the assignments, re-submission of assignments, completion of Complete course.

Various types of Machine learning can be used to predict the output of students. Supervised learning is utilized the independent variable to predict the behaviour of dependent variable. Data is transformed using techniques like exploratory Data Analysis and based on these transformed data, relevant data is filtered for example

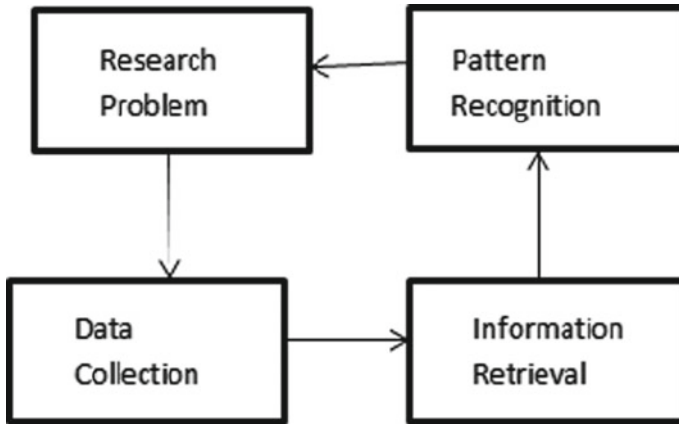

Fig. 4 Data driven predictive model through machine learning

percentage of students completing the course or submitting assignment, predictive model is created that can predict the grades of students, if they have completed course [30].

6 Machine Learning in Instructional Applications

Machine Learning based Instructional applications requires the knowledge in domains:

- (i) **Conceptual Knowledge:** In the computer algorithms, conceptual knowledge is represented in the form of Semantic networks. Concepts is the knowledge about facts and relation between different facts. Nodes in the semantic networks represents the concepts and links represents the relation between these concepts (Fig. 5).
- (ii) **Procedural Knowledge:** Procedural knowledge is the knowledge to understand the subjects that follows a definite pattern or procedure during learning for example Mathematics, spoken sentences, computer programming etc. These systems typically consists three parts; working memory, rule set and rule Interpreter.

Working Memory: It contains information about the solution. It also hold the intermediate calculations and also stores information about the attention of problem solver.

Rule Set: It is set of rule that works for providing solution and it also has potential for changing the working memory based on the current results in intermediate calculation s. It has two parts:

- (a) **Condition:** Base on the condition, rules are applied on working memory.
- (b) **Action:** It governs the process applied to working memory.

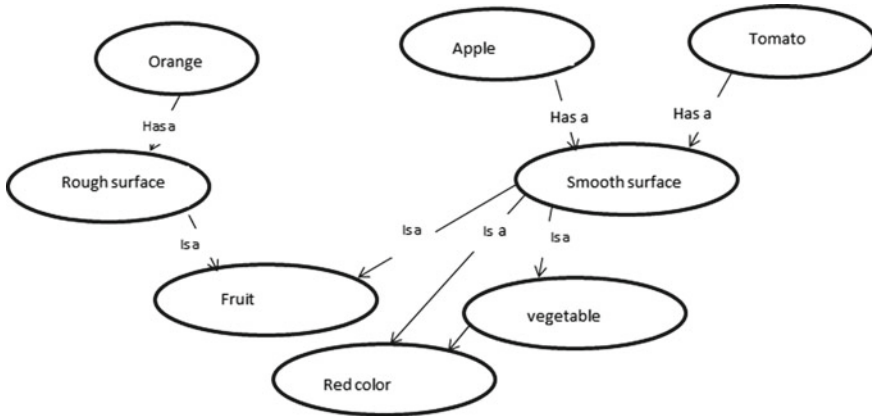

Fig. 5 Example of a semantic network

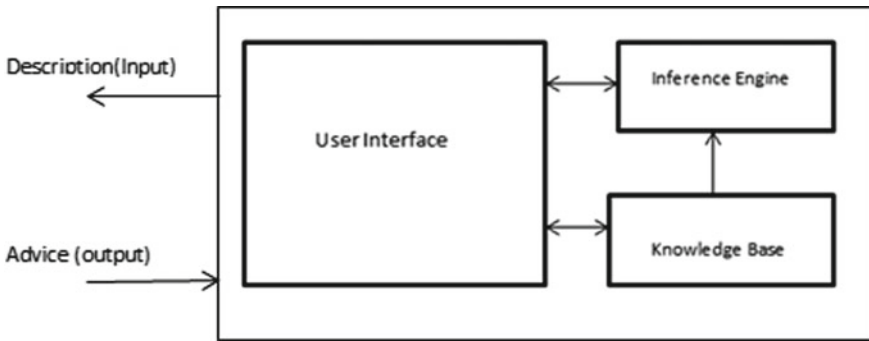

Fig. 6 Major part of expert system

One or more than rule may be applied during the execution by interpreter. Rule based systems are used in expert system used to solve tough technical problem using *Inference engines* [31].

- (iii) Imaginal knowledge: Imaginal knowledge seems to be basically about the perception of things. Computer graphs are mainly used in such application. However, with the advancement in Machine learning, systems based on pattern recognition are also applied to create application.
- (iv) Problem Solving Skills: Problem solving skills requires forward reasoning and backward reasoning. These methods are specifically termed as Artificial Intelligence. Importance of expert systems in academics is intelligible so it generates necessity of brief discussion on Inference engines in academics where problem solving skills has a significant role. These engine generally utilizes forward and backward chaining as a part of reasoning systems (Fig. 6).

Inference engines works on forward chaining and backward chaining models to obtain logical conclusion. They can utilize top to bottom or bottom to top computational models. Facts and knowledge pertaining to any task and rules required to implement that task is kept with Knowledge base of system [32].

(a) Forward Chaining:

It is based on bottom- model of computation. It uses information from known facts to draw a reasonable conclusion. New facts are generated with the knowledge of known facts to reach a pre- determined goal. This works in cycles and continues until no new rule can be drawn. Facts are checked against the predetermined goals indicating forward movement of inference towards goals from the facts.

(b) Backward Chaining:

Backward chaining is a goal driven search and it is based on the hypothesis testing. Here goal is known and different variables are searched to valid facts in data. It is based on top-down model of computation. In an expert system, it works by checking memory for new goal, to confirm, whether, rules are listed in memory and to continue the recursive program to find any area where any rule is not applied. Information about this area proves the sub goals and original goals.

Machine learning has a wider role in educational application and system. These applications can be utilized as setting up of course module, tutoring, assessment, determining learning outcome and even in predicting the career. Adaptive learning systems can be customized based on the cognitive skills and behavior of individual or a group of students.

Apart of learning processes, it is highly useful in the assessment and evaluation that sometimes becomes monotonous tasks for teachers. It can provide substantial time to teachers to create innovative methods for improved learning environment.

Huge data sets received from Massive open online Courses is quite useful in educational research. This large amount of data can be modeled using machine learning technique to create predictive models.

Education is one of the sensitive area and new and accurate methods of Module delivery, feedback systems and problem solving are developed.

References

1. J.J. Lu, L.A. Harris, in *Congressional Reasearch Service* (2018). www.crs.gov, In Focus
2. R. Luckin, W. Holmes, M. Griffiths, L.B. Focier, *Intelligence Unleashed: An Argument for AI In Education*, Pearson (2016)
3. M. Noorian, E. Bagheri, W. Du, Machine learning-based software testing: towards a classification framework, in *Proceedings of the 23rd International Conference on Software Engineering & Knowledge Engineering* (2011)
4. C. Murphy, G. Kaiser, M. Arias, *An Approach to Software Testing of Machine Learning Applications*. Columbia University Computer Science Technical Reports (2007)

5. S. Amershi, C. Conati, Unsupervised and supervised machine learning in user modeling for intelligent learning environments, in *Proceedings of 12th International Conference on Intelligent User Interfaces*, pp. 72–81 (2007)
6. Y. Liu, L. Zhang, L. Nie, Y. Yan, D.S. Rosenblum, Fortune teller: predicting your career path, in *Proceedings of the Thirtieth AAAI Conference on Artificial Intelligence* (2016)
7. Y. Lou, R. Ren, Y. Zhao, *A Machine Learning Approach for Future Career Planning*
8. H.F. El-Sofany, N. Al-Jaidah, S. Ibra-him, S. Al-kubaisi, Web-based “Questions-Bank” system to improve E-Learning education in Qatari school. *J. Comput. Sci.* **5**(2), 97–108 (2009), 2009 ISSN 1549-3636
9. M. Liu, R.A. Calvo, V. Rus, Automatic question generation for literature review writing support, in *International Conference on Intelligent Tutoring Systems, Intelligent Tutoring Systems*, pp. 45–54 (2010)
10. D. Liu, C. Lin, Sherlock: a semi-automatic quiz generation system using linked data, in *13th International Semantic Web Conference* (2014)
11. K. Greff, R.K. Srivastava, J. Koutn'ík, B.R. Steunebrink, J. Schmidhuber, *LSTM: A Search Space Odyssey, Transactions on Neural Networks and Learning Systems* (2015)
12. H. Sak, A. Senior, F. Beaufays, *Long Short-Term Memory Recurrent Neural Network Architectures for Large Scale Acoustic Modeling*. Cornell University Library (2014)
13. T. Liu, S. Fang, Y. Zhao, P. Wang, J. Zhang, *Implementation of Training Convolutional Neural Networks*. Cornell University Library (2015)
14. V. Kalogeiton, Introduction to Convolutional Neural Networks, Reading Group on Deep Learning: Session 3 (2016)
15. I.E. Fattoh, Automatic multiple choice question generation system for semantic attributes using string similarity measures. *Comput. Eng. Intell. Syst.* **5**(8) (2014), ISSN 2222-1719 (Paper) ISSN 2222-2863 (Online)
16. L. Padrio, *Statistical Methods for Natural Language Processing* (2009)
17. M. Collins, *Statistical Methods in Natural Language Processing*. AT&T Labs–Research
18. A.A. Khan, O. Naseer, Fuzzy logic based multi user adaptive test system. *Int. J. Soft Comput. Softw. Eng.* **2**(08) (2012), e-ISSN: 2251-7545
19. W. Huang, Z.-H. Wang, Design of examination paper generating system from item bank by using genetic algorithm, in *Proceeding of International Conference on Computer Science and Software Engineering* (2008)
20. A.V. Sharma, Review of evolutionary optimization algorithms for test case minimization. *Int. J. Eng. Comput. Sci.* **4**(7), 13292–13297 (2015), ISSN:2319-7242
21. V.U.B. Challagulla, F.B. Bastani, I.-L. Yen, R.A. Paul, Empirical assessment of machine learning based software defect prediction techniques. *Int. J. Artif. Intell. Tools* **17**(2) (2008)
22. J.F. Sowa, Conceptual graphs as a Universal knowledge representation. *Comput. Math. Appl.* **23**(2–5), 75–93 (1992), ISSN -0097-4943/92
23. A. Jefferies, R. Hyde, Building the future students’ blended learning experiences from current research findings. *Electron. J. e-Learning* **8**, 133–140 (2010)
24. F. Duzhin, A. Gustafsson, Machine learning-based app for self-evaluation of teacher-specific instructional style and tools’ education sciences. *MDPI J.* (2018)
25. M.A. Razek, C. Frasson, M. Kaltenbach, Toward more cooperative intelligent distance learning environments. *Softw. Agents Coop. Hum. Activity* (2002). <http://www.perso.iro.umontreal.ca/~abelram>. Accessed Feb 2003
26. H. Shi, Y. Shang, S. Chen, A multi-agent system for computer science education, in *Proceedings of the 5th Annual SIGCSE/SIGCUE ITICSE Conference on Innovation and Technology in Computer Science Education*, pp. 1–4 (2000)
27. L. Aroyo, P. Kommers, Special issue preface, intelligent agents for educational computer-aided systems. *Interact. Learn. Res.* **10**(3/4), 235–242 (1999)
28. R.S.J.D. Baker, K. Yacef, The state of educational data mining in 2009: a review and future visions. *J. Educ. Data Min.* **1**(1), Fall (2009), Article 1
29. L. Kidzi nski et al., A tutorial on machine learning in educational science, in *Proceedings of International Conference on Future Buildings and Districts—Sustainability from Nano to Urban Scale—Vol. II*, Scartezzini, Jean-Louis (2015)

30. C.J. Burges, A tutorial on support vector machines for pattern recognition. *Datamining Knowl. Discov.* **2**(2), 121–167 (1998)
31. H.M. Half, Instructional applications of artificial intelligence. *Educ. Leadersh.*, 24–31 (1986)
32. A. Al-Ajlan, The comparison between forward and backward chaining. *Int. J. Mach. Learn. Comput.* **5**(2) (2015)

Network-Based Applications of Multimedia Big Data Computing in IoT Environment



Anupam Singh and Satyasundara Mahapatra

Abstract In the modern business world, business management techniques are continuously increased and governed by smart devices and innovative technologies. These devices are associated with internet can be called as a device of Internet of Things (IoT). Wi-Fi, Bluetooth, Infrared and Hotspot technologies are the connecting medium for these devices. Somehow, these devices are connected to the servers for processing the user request. These sensing devices are producing enormous amount of data in structured or semi-structured or unstructured form otherwise known as big data. The data are stored, manipulated and analyzed with the help of big data techniques for taking well-defined decisions. Thus, the top management people of the business world are able to drive their business in real time. The uses of smart devices are rapidly increased in different application categories of IoT known as Personal, Group, Community and Industrial. Due to easy access to internet, independent power source and sensing without human intervention makes smart devices as an important component of IoT. This chapter first gives a brief introduction on IoT with its structure. Then different technologies are discussed in the field of IoT. The different application areas of IoT are also presented. Finally, Big Data and the importance of IoT based sensor devices in Big Data is presented.

Keywords Big data · IoT · RFID · Bluetooth · Wireless sensor network

1 Introduction

Internet of Things (IoT), the most remarkable network of intelligent electronic devices stands for “Connect with everyone, everything, always, everywhere for each service and each network” [1]. This development brings an immense revolution in

A. Singh (✉) · S. Mahapatra

Pranveer Singh Institute of Technology Kanpur, UP Bhautipratappur, India
e-mail: anupam2007@gmail.com

S. Mahapatra

e-mail: satyasundara123@gmail.com

© Springer Nature Singapore Pte Ltd. 2020

S. Tanwar et al. (eds.), *Multimedia Big Data Computing for IoT Applications*, Intelligent Systems Reference Library 163,
https://doi.org/10.1007/978-981-13-8759-3_17

the field business world. Catching information with the help of smart devices, store it and take decision for business world with the help of emerging technologies is the way Big Data is handled. These smart devices are connected through internet and send contextual information such as location, temperature, auto generated machine reports, etc. at any time or any moment from one location to other location [1]. The devices are executed with the help of sensors and processors. Due to lower price of sensors, processors and spreading of internet connection, the usages of these devices are increased strongly. Hence in real business world these devices are used as human necessity rather than “good to have.”

As per the Gartner expectation the number of users who uses the smart devices will be rise to 20 billion by 2020 while the other scientist estimate that it should be 50 billion [2]. But in order for this to happen, only holding smart devices is not the solution. The requirement is, design a device with its own internet, independent power source and a way of sensing the physical environment [2]. Somehow, to happen these things a number of technologies are very much available with us. These are RFID, Bluetooth, 3G, 4G, 5G, wireless sensor networks, solar chargeable batteries, and portable devices. These technologies are operated with the help of sensor devices. These devices are not only very much capable to collect, analyze, transmit a large set of structured, unstructured or semi-structured data in real time but also monitored and control the complex industrial processes. For that reason, without data, the IoT devices do not have features and capabilities that have been backed by worldwide attitudes. These large set of data are otherwise known as Big Data.

IoT is an excellent driven approach to implement in today’s business world [3, 4]. But the biggest problem for enterprises is how to generate the huge amount of data, collect those data, store them in an efficient manner for processing them to achieve their business objective. For generating such amount data is only possible with the help of the things and technologies used in IoT. Hence the researchers as well as the engineers are relaxed by using these devices. But still they are facing challenges in some research related work and real time scenario. i.e. how to manage these massive and heterogeneous data in highly distributed environment [3, 4]. This is possible only with the help of wear Operating System by Google such as Android Wear known as ‘brain’ of human Body area Network (BAN) [5] which gives the storage and communication capabilities of smart devices. Last but not least with technologies such as Near Field Communications (NFC) [6]. The smart sensor devices are also used as actuators and the actions with trigger control the devises like televisions, moor car, etc.

This chapter presents an overview on Internet of Things (IoT) like Bluetooth, Wi-Fi, Optical tags and quick response codes, Bluetooth, Body area Network (BAN), Near Field Communications (NFC), etc. A number of applications with the help of smart devices interconnected to other devices are discussed. Big Data and the role of IoT in big data are also discussed. The processing of IoT based big data is discussed through which how the business world will be benefited are also discussed. At the end of this chapter the future opportunities of IoT and it’s use in big data analysis for business development is discussed.

2 Internet of Things (IoT)

IoT is an wide and expanded networks of intelligent devices that are auto organized among them and share their data, information and resources over internet for changing the environments in a smart way [7]. The advanced IoT aims to enhance the lifestyle of peoples by using “smart” devices in the environment, which is fully integrated with Internet [4]. This will convert the people-to-people communication lifestyle to device-to-device communication lifestyle. It is also expected that the model of IoT includes a huge numbers of smart devices that are actuating, sensing and processing for establishing connection with Internet [8]. As the time passes away, the numbers of smart devices otherwise known as “things” which are connected to the internet are increased and finally these things are the major producers as well as the consumers of the data or resources. These things are obtain their data or resources from the physical world in real time over Internet by using wireless technology or through gateway [8]. These things are also able to connect other things and obtain the information by sensing and make independent decision [9–11].

In today’s world, IoT is a primary need for the business world. This world depends on other enterprises to fulfill their requirements time to time. These needs of their requirements are maintained very easily with the help of smart devices or things. The ability of tracking their requirements make entrepreneur more efficient by speed up their process, reducing error and prevent theft through IOT [8]. Providing an authenticated and satisfactory connection to those smart devices of their companies is a big challenge. In this direction, the things of IoT can play bigger role as it was always connected with Internet through several communication interfaces, availability of many useful features, significant storage capacity and ability for taking decision by computing [12]. The term IoT has attracted the attention of today’s IT world with a vision by projecting the global infrastructure of physical objects connected in a common network, enabling anytime, anywhere for everybody [13]. The IoT is also trying to create a global network, that communicates between people-to-people (P2P), people-to-things (P2T), things-to-things (T2T) (i.e. anything-to-anything) by providing a unique identity [14].

3 Structure of IoT

IoT is a large network of sensor devices, like RFID, barcodes, wired and wireless access, as well as the subnets of intelligence devices (i.e. computers) connected through a range of intermediary technologies that can act as a means of connectivity possible. International telecommunication Union (ITU) provide the structure of IoT and classified into four dimensions as given in Fig. 1 [15, 16].

For tagging things, RFID plays a vital role by automatically identifying a thing in real time for complete the identification process [17]. For Feeling thing, sensors are collecting the data from the environment by establishing the communication between

Fig. 1 Structure of internet of things [59]

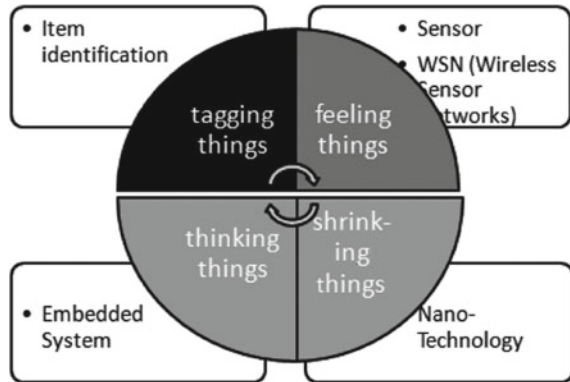

physical and information world: for example measure the temperature and pressure [18]. In case of shrinking things, nanotechnology has been applied for connecting within small things: for example “for monitoring the quality of water in reasonable cost by using nano-sensors [18] in the field of healthcare the use of nano-sensors is utilized for diagnosis and treatment of diseases like HIV and AIDS [19]. In case of thinking, the embedded intelligence thing has established the network connection to the Internet with the help of sensors: for example maintaining the freshness of perishable items inside the refrigerators.

4 Technologies Used in IoT

IoT is a system, where the interrelated computing sensor devices or things are connected among themselves with the help of a number of technologies. Some of the technologies are discussed below.

4.1 Radio Frequency Identification (RFID)

RFID is a well known automated wireless identification mechanism [7]. It consists of three components named as scanning antenna, transceiver and RFID tags. This tag consists of a microchips, memory and antenna. It works on radio frequency waves for transmitting the signals. The tags are first activated with the help of this signal. After that the activated tag send a wave back to antenna, then it translated into data. RFID tags are basically two types named as active tag and passive tag. Active tag has work with its own energy source, i.e. a battery. On the other hand, passive tag draws energy from the reading antenna, whose electromagnetic wave activates the energy in the RFID tag’s antenna. These tags are classified into two categories on the basis

of their memory types. These are read-only and write only. The RFID technology is divided into four types on the basis of low, high, ultra-high and microwave frequency [7, 20].

4.2 Barcode

Barcode is an optical of machine-readable form of a product to which it's stick. It is a way to code the numbers as well as letters with a formulation which includes space and different size of bars. It looks just like numbers of black lines with different width are placed in the form of square or rectangle with gaps [7]. These images are read by a laser scanner known as Barcode reader. These images are also read by using cameras [7]. The reader read these line thickness and space by the help of laser beam [7]. Then the reader transforms the reflected light into digital form for immediate intervention or storage. These barcode are basically three types named as Numeric, Alpha Numeric and Two dimensional [7].

4.3 Electronic Product Code (EPC)

Electronic Product Code (EPC) is used for single identification. In general EPC is an advanced form of barcode. EPC has its own numerical formulation system with greater capabilities for recognizing the products. In EPC the contained numbers are associated with specific information. These are the information of manufacture, starting point and end point of a shipment [7]. EPC consists of four parts, namely ONS (Object Naming Service), EPCDS (EPC Discovery Services), EPCIS (EPC Information Services) and EPCSS (EPC Security Services) [21]. EPC is designed in such a way so that it placed on a RFID tag and transmits data and activated when a signal is released from a reader. In today's fast moving environment the industry-driven standard of EPC was maintained by EPCglobal, a neutral and non-profit organization [22].

4.4 Internet Protocol (IP)

IP or Internet Protocol is a technique or protocol through which data or information is transmitted from one intelligence device to another over internet. The objective is to assign at least one IP in the form of binary to each intelligence device for achieving the uniqueness [7]. In the current scenario two version of IP are exist. They are IPv4 (IP version 4) consists of 32 bits and IPv6 (IP version 6) consists of 64 bits [7]. IPv6 and IPv4 are two completely separate protocols and not compatible with each other.

So these protocols cannot interact with each other directly but with the help of “dual stack” system exchanging data between IPv4 and IPv6 is possible [21].

4.5 Wireless Fidelity (Wi-Fi)

Wi-Fi is a network connectivity technology used for transferring high-speed data over short distance by using radio wave based devices (router, laptop, smartphones, etc.). These devices are bases on IEEE 802.11 standards in 1997 [3]. Different types of Wi-Fi standards are used by the wave-based devices. These standards are 802.11a, 802.11b, 802.11 g, and 802.11n [7, 23]. Now a day this wireless connectivity is an established part of everyday life. All smart devices like smartphones, laptops, tablets, cameras and very much other devices are used Wi-Fi connectivity. Due to the high-speed data transfer nature, Wi-Fi technology is highly accepted by hotels, homes, airports, and cafes in the society by using wireless access points [23].

4.6 Bluetooth

Bluetooth is a short-range low-cost wireless communication technology. With the help of this technology smart devices like smartphones, laptop, printer, cameras, tablet, PDAs, and other peripherals are transmitted data or voice wirelessly in short distances. The main purpose of Bluetooth technology is to replace the cables that normally connect with devices and keep a secured communication between the devices [24]. This technology was developed in the year 1994. It uses almost same frequency as other wireless technologies like cordless phones and Wi-Fi routers are used. It generates a 10 m radius wireless communication network known as personal area network (PAN), which can establish the communication between two to eight smart intelligence devices. This low cost and short-range wireless network allows us to send data like images, videos, voice and commonly text between the devices. The most important part of the Bluetooth technology is, it uses less power than the Wi-Fi technology. Its low power makes it less far from any of the other wireless devices in the 2.4 GHz radio band. Bluetooth v3.0 with high-speed technology incorporated devices can transfer up to 24 Mbps of data, which is faster than the 802.11b Wi-Fi standard, but slower than 802.11a and 802.11 g Wi-Fi standards. It was expected that as the technology has evolved, Bluetooth speeds have increased.

4.7 ZigBee

ZigBee is a wireless technology used for transmits data from one intelligent device to another in low cost and low power [25]. Specifically it was designed to control the

sensor network on IEEE 802.15.4 standard used for WPANs. This device is designed by ZigBee alliance and operates at 868 MHz, 902–928 MHz and 2.4 GHz frequencies only [25]. This is a very simple and less expensive communication system used widely for short-range wireless networks like Wi-Fi and Bluetooth. The communication network of ZigBee is also utilized for wide area network with the help of routers and allow other intelligent devices to join in his network. The ZigBee communication system consists of at least one coordinator, router and an end device for its operation in an efficient manner [25]. The coordinator behaves like a root and creates a bridge between the networks. The responsibility of ZigBee coordinator is to keep track of data when the transmission is performed and also store the data. It works like an intermediary router which gives permission to route the data through him from one device to another. The ZigBee devices connect themselves through the parent node of end device and maintain the life of the energy unit (i.e. battery) for long time. The router, coordinator and end device numbers are calculated on the type of network (i.e. star, mesh, tree, etc.) for which it works.

4.8 Near Field Communication (NFC)

NFC is a wireless communication technique on wave for intelligent compatible devices [7]. The benefit is, a user can transmit the data or information without needing to touch both the devices together. This technology is designed and developed by jointly “Philips and Sony” in the year 2004. This technology is very popular in Europe and Asia. It was also migrated to United State because of its popularity. This technology comes under the category of short-range wireless connectivity standard (i.e. ISO/IEC 14443). It creates a magnetic field for enabling the communication [26]. NFC technology started becoming widely available to consumers in the field of mobile payment like Google Wallet and mobile ticketing like Oyster Card [26].

4.9 Wireless Sensor Networks (WSNs)

WSN is a wireless sensor based network, specifically designed for the sensor devices which are available at distributed autonomous location. These devices are monitored the environmental conditions like pressure, location, temperature, heat, light etc [7, 27]. A WSN system built a wireless gateway among the distributed sensor devices. This sensor device consists of several technical components. These components are radio, power bank, microcontroller, analog circuit, and sensor interface. The radio technology of WSN system is consuming more battery power. So today’s WSN systems are based on ZigBee due to its low consumption power. Depending on the environment, different types of WSN networks are selected and can be deployed underwater, underground, on land, and so on. These types of WSNs are used in different application areas like agriculture monitoring, Home Control, Build-

ing Automation, Industrial Automation, Medical Applications, military applications, highway monitoring, civil and environmental engineering applications, etc [27].

4.10 Actuators

Actuators are a electro-mechanical intelligence devices which is responsible for moving and controlling a system [7, 28]. It was operated by electrically, manually or various type of fluids (i.e. air, hydraulic, etc.) energy and convert to some kind of motion [7]. One common type of actuator named as pneumatic cylinder is powered by air and known as airtight cylinder. This is made from metal and used for storing energy of compressed air. These compressed airs move a piston when the air is released. It works much like a human finger. In the field of IoT, The actuators are utilized whenever there is a need to operate another device by applying a force.

4.11 Artificial Intelligence (AI)

Artificial intelligence (AI) is an area where the intelligent machines are simulated from the experience in such a way, so that it performs a task as human performs. These machines are connected with network to perform their daily activities and made human life easy [7]. These machines are also very sensitive and responsive to human's presence and activities [7]. The process for simulation of human intelligence and machine are including learning, reasoning and training. The intelligent machines are characterized as Embedded, Context Aware, Personalized, Adaptive and Anticipatory. The different application of AI are expert systems, speech recognition and machine vision [7].

5 Architecture of IoT

In today's world, the technological field of IoT extends into a very wide range. Billions to trillion of heterogeneous object or things are trying to connect themselves over the internet. So there is a need for a perfect reference model. The growing numbers of architectures of IoT are not able to give a perfect reference model [29]. The basic model provided a 3-layer architecture [26, 30], which have Application layer, Network layer, and Perception layer. Some other reference models of IoT architecture are also proposed and discussed in the literatures [31–33] with more abstraction. A very common and interesting view of a reference model named as 5-layer architectural model is briefly described below with the help of Fig. 2.

The First layer is known as object layer, otherwise known as perception layer. This layer is responsible for performing the functionalities like collecting informa-

Fig. 2 5-layer architectural model of IoT

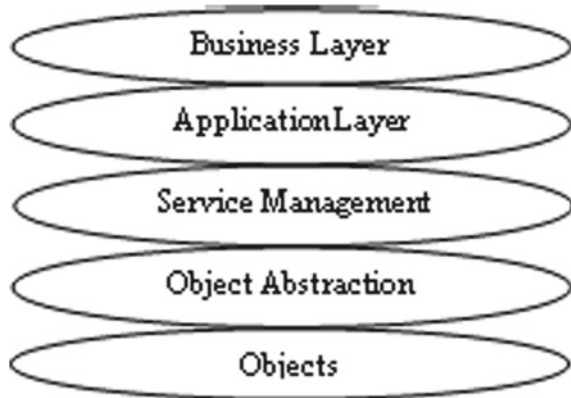

tion about location, weight, temperature, etc. by using standardized heterogeneous devices which have plug-and-play mechanism. This layer is also responsible for digitalizing the data and sends them through a secured channel to the next layer. The perception layer of IoT is the creator of Big data [29]. The second layer is Object Abstraction Layer and responsible for transferring the data which are collected in perception layer to the next layer. These data can be transferred through various devices having wireless technologies like RFID, 3G, GSM, Wi-Fi, Bluetooth with Low Energy, infrared, ZigBee, etc. [29]. This layer is also handling the data management process as well as cloud computing [31]. The third layer is known as Service Management layer Middleware layer. This layer is responsible for pairing a service with its requester based on addresses and names. This layer enables the IoT application programmers to work with heterogeneous devices or objects. This layer also processed the received data, take decision and provide the required services over the wireless network [32, 34]. The fourth layer is Application layer and responsible for providing the services requested by the customers. The ability of providing quality intelligent services to the customers need until their satisfaction is the main motto of this layer. The importance of this layer is to provide high-quality intelligent service as per the customer requirements. This layer is responsible to make smart and automated many business market domain such as home, building, transportation, industry, and healthcare [31, 33]. The fifth layer is Business Layer and maintains the overall activities and services of a system. This layer is responsible for building business models and makes it possible to take support decision by analyzing big data [29]. This layer is also responsible for monitoring and managing the above four layer of IoT architecture. Apart from this an architecture on e-health care is also proposed in [35]. FlexRFID, a middleware architecture of IoT was also implemented on different application domains like supply chain management, smart library management and healthcare sector [36–38].

6 Application Areas of IoT

In the professional life or day to day life humans are curious in nature. These curiosities provide a new begin where human start to make machines smart enough, so that it reduces the work load. The designed interconnected smart devices have captured the data and shared these data between machine to machine or machine to human or human to machine on a daily basis in different application areas of IoT. They are Logistic and supply chain management (SCM), transportation, healthcare, and environment and disaster monitoring, etc. [39].

6.1 *Logistics and Supply Chain Management (SCM)*

There are huge potential for applying IoT in many domain areas of Supply Chain Management. It helps the objects to communicate freely and enables better control on the logistics as discussed in [39–41]. It increases the efficiency of the process by scanning the data with the help of RFID tags, barcodes, NFC, and mobile phones and creates a smart ways of transmitting the things by using transmission protocols such as WSNs, GSM network, 3G, 4G, or even 5G networks, it brings in transparency in an organization [39]. It creates the real-time visibility of inventory system and brings transparency in an organization. A numerous examples on different application of IoT in the field of logistics and SCM are discussed in [39]. A supermarket chain management, where things (goods) are tracked and maintained the stock automatically by using WSNs, barcodes, and RFIDs is illustrated in [40]. The Use of Aspire RFID with session initiation protocol (SIP) to detect the location and mobility management of RFID tags is discussed in [39]. The design of Logistic Geographical Information Detecting Unified Information System Based on IoT is discussed in [42]. The concept of “circular economy,” with the help of supply chain where tagging a product from manufacturing unit to the end of product life i.e recycling enables a new way of resource optimization is discussed in [43].

6.2 *Transportation*

IoT transforms the transport sector by optimizing the movement of human and things (goods), economy of the country and safety of the public. This smart transport system will automate the roads, railways, airways transform the experiences of passengers and give a new form to the way of goods tracked and delivered. The monitoring of road in real time and provide the status of road condition as alert system reported is discussed in [44]. Applications like license plate identification, parking place indexing and secure vehicle system are reported in [45]. A vehicle monitoring system based on WSN for measuring the performance of lithium-ion batteries used in electric

vehicles and enhance the uses of batteries by providing the route status to the driver is discussed in [46]. By using the IoT system the manufactures of electric vehicles provide a battery monitoring system and their charging schedule is presented in [43]. A fully autonomous vehicle integrated system, parking sensor system is also presented in [43]. How to improve customer experience and control the flow of passenger in London City Airport and provide them the “doorstep to destination” data time to time with the help of smartphone is discussed in [43].

6.3 Healthcare

The benefits of IoT technology have greatly reflected on healthcare. IoT intelligence devices are multiplied and used across the entire healthcare industry throughout the world. These devices are portable heart rate, check blood pressure and blood sugar, smart pill boxes, etc. A cooperative IoT based approach for better health monitoring and control of rural and poor human is proposed in [47]. How IoT is able to shift healthcare from cure to prevention, and give people a greater control over their decisions is discussed in [43]. The uses of smartphone for monitoring vital signs and transmit health data directly to the care centers are proposed in [48]. This system provides emergency help to patients, who suffer from critical illness. As most of the IoT devices are connected via the cloud, healthcare providers i.e hospital can constantly and consistently check-up their patients.

6.4 Environment and Disaster

Hurricanes, earthquakes and tsunamis that destroy everything. Due to lack of technical resources and physical obstacles execute the work of the emergency services is very difficult. Thanks to the devices of IoT, those are being seen as a solution for reducing the impact of these disasters [39]. These devices are made up of smart sensors and connect themselves with the help of Internet. They transmit information in real time and help the disaster recovery process. Sensors are also utilized to monitor physical or environmental conditions, such as temperature, pressure and sound etc. and pass their data through the network for taking right decision of facing a disaster [39]. A Long-Term Environmental Monitoring system with the help of WSN is discussed in [49].

6.5 Smart Home

A smart home, otherwise known as automated home where the available devices placed anywhere is controlled remotely from any place in the world. These devices

are interconnected through internet and accessible through one central point [50, 51]. This central point is a smart device like smartphone, tablet, laptop, game console, etc. Examples like Door locks, televisions, home monitors, cameras, lights and even appliances such as the refrigerator can be controlled through one home automation system. The whole system is installed on a smart network device for certain changes to take effect time to time. These devices come with self-learning skills. It learns the homeowner's schedules and adjusts as needed. A Bluetooth based home automation system is discussed in [52].

6.6 Smart Farming

In Smart farming, The IoT based intelligent devices are monitoring the crop and give information so that the farmer able to take decision instantly with the help of expert management system. This makes our system as an automated irrigation system discussed in [43, 50]. Sensors can also used for tracking animals, diseases, etc. The farmer can monitor the field condition from anywhere. The IoT based automated farming system is more efficient than the traditional farming system. The farm who uses smart farming can share their data with other firm, consumers and regulators [43]. The smart farming not only targets conventional large farming operations, but also provide new levers to uplift other growing trends in agricultural like organic farming, family farming and enhance highly transparent farming. From environmental point of view, smart farming can provide a lot of benefits like efficient water usage, optimize use of fertilizer and meditational treatments if required in the field. A special Android application for with user-friendly GUI for irrigation control by using smartphone is developed and presented in [53].

7 Big Data

Big Data is an important topic for today's business world where the data sets are so large and produced at astronomical rate [54]. These data cannot be managed and analyzed efficiently by traditional data mining and handling techniques. The types of data are unstructured or sensitive w.r.t time or very large in size and not able to process by the engine of relational database [55, 56]. Such type of data requires an efficient processing approach called as Big Data. To make sense of such huge amount of data, they are often categorized into five V's named as Velocity, Volume, Value, Variety, and Veracity as reported by Google (Fig. 3).

- Velocity refers to the speed at which the large amounts of data are being generated.
- Volume refers to the unbelievable amount of data generated per second.
- Value refers to worth of the data being extracted.

Fig. 3 5V's of big data

- Variety refers to the different types of data (i.e. Structured, Unstructured and Semi-structured)
- Veracity refers to the quality or trustworthiness of the data (Fig. 3).

In the recent trend the Big Data technology analyze the data at the time of generation without storing in database because collecting the huge data and then analyzing it is a big challenge from the point of view of organisation. The most important part of such data is to realize it's cost and benefit. The new and efficient big data technologies allow the structured, unstructured and semi-structured data for harvesting, storing, utilizing and the trustworthiness of the data is also maintained at the same time.

8 Role of IoT in Big Data

When business world wants to analyze the huge amount of data, IoT plays a vital role as a source of those data [54]. This is the point where the role of IoT in Big Data comes into the picture. To analyze the IoT sensor devices data, the big data analytics is emerging as a key. This helps the entrepreneurs of business world for making fruitful decisions to achieve their goal. The role of IoT is to generate huge amount of data in real time w.r.t the concept of 5Vs. These data are processed and stored in distributed locations. The IoT based big data are processed as follows:

1. Huge amounts of structured, unstructured and semi-structured data are generated by IoT based smart sensor devices. These data otherwise known as big data depend on Velocity, Volume, Value, Variety, and Veracity. i.e. 5Vs.
2. The huge amount of data generated in step 1 is stored in big data files, which is a shared distributed database.
3. These IoT based big data is now analyzing with the help of analytic tools like Hadoop MapReduce or Spark.
4. Finally the reports are generated by analyzing the data (Fig. 4).

There is a strong interdependent relation between big data and IoT, as they help each other for taking decision in real time for business world [57, 58]. As the business

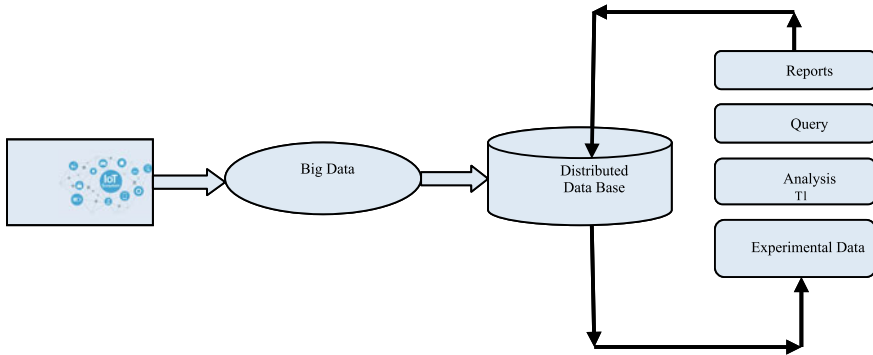

Fig. 4 IoT based big data processing

grows, IoT sensor devices also grow and it creates more demands on the capabilities of big data. Due to the huge amount of data generated by IoT based sensor devices, the traditional data storage technology unable to store the data. As a result, more advanced and innovative storage technology are designed and developed and update the big data infrastructure of the business organisation. Due to this updating the IoT based big data combined applications are expedite the scope of research in both the areas. Hence, from the perspective of IoT, it is the fuel that drive the big data technology.

9 Conclusion

IoT or Internet of Things is a system of interconnected intelligent devices with unique identifier and ability to transfer data or information over a wireless network automatically. This allows the development of intelligent devices and its applications in the field of energy, logistics, industrial control, retail, agriculture, etc. The word “things” in IoT refers to the devices which have unique identifiers and allow remote sensing, remote monitoring and actuating. This chapter tries to present a brief overview on the structure of IoT from point of view of International telecommunication Union (ITU). A numerous data transfer technologies are utilized by the sensors or devices of the IoT system. Some of the technologies named as RFID, Barcode, EPC, Internet protocol, Wi-Fi, Bluetooth, ZigBee, NFC, WSNs, Actuators and AI are explained briefly in this chapter. From the architectural point of view, A 5-layer architectural model of IoT is briefly described. As internet is hype of the IoT, it has many application areas. A few application areas such as Supply chain management, Transportation, Healthcare, Environment and disaster, Smart home and Smart Farming are briefly described in this chapter. Big data and the role of IoT in big data for business world

is also explored in this chapter. The IoT based big data processing is also described in this chapter. Through which the business organisations are able to analyze IoT based big data, manage them and able to take well-informed decision for their future goal.

References

1. S.M.R. Islam, D. Kwak, M.D.H. Kabir, M. Hossain, K.S. Kwak, The internet of things for health care: a comprehensive survey. *IEEE Access*, **3**, 678–708 (2015). <https://doi.org/10.1109/ACCESS.2015.2437951>
2. P. Mukherjee, the smartphone and the internet of things [Internet] (2015). <http://praxis.ac.in/the-smartphone-and-the-internet-of-things/>. Accessed 2 Oct 2018
3. S. Meyer, A. Ruppen, C. Magerkurth, Internet of Things-aware process modeling: integrating IoT devices as business process resources, in *Proceedings International Conference on Advanced Information Systems Engineering*, pp. 84–98 (2013)
4. D. Mourtzis, E. Vlachou, N. Milas, Industrial big data as a result of IoT adoption in manufacturing. *Procedia CIRP* **55**, 290–295 (2016)
5. T. O'Donovan, A context aware wireless body area network (BAN), in *Proceedings 3rd International Conference Pervasive Computing Technologies for Healthcare (Pervasive-Health 2009)*, pp. 1–8 (2009)
6. C. Faulkner, What is NFC? everything you need to know, November 2015. Techradar.com
7. S. Madakam, R. Ramaswamy, S. Tripathi, Internet of Things (IoT): a literature review. *J. Comput. Commun.* **3**, 164–173 (2015). <https://doi.org/10.4236/jcc.2015.35021>
8. G. Aloï, G. Caliciuri, G. Fortino, R. Gravina, P. Pace, W. Russo, C. Savaglio, Enabling IoT interoperability through opportunistic smartphone-based mobile gateways. *J. Netw. Comput. Appl.* **81**(74–84) (2017)
9. G. Fortino, P. Trunfio, *Internet of Things Based on Smart Objects, Technology, Middleware and Applications*. Springer (2014). ISBN 978-3-319-00490-7
10. G. Fortino, D. Parisi, V. Pirrone, G. Fatta Di, Bodycloud: a saas approach for community body sensor networks. *Future Gener. Comput. Syst.* **35**(6), 62–79 (2014)
11. G. Fortino, A. Guerrieri, W. Russo, C. Savaglio, Integration of agent-based and cloud computing for the smart objects-oriented IoT, in *IEEE International Conference on Computer Supported Cooperative Work in Design—CSCWD*, pp. 493–498 (2014)
12. G. Aloï, G. Caliciuri, G. Fortino, P. Pace, A smartphone-centric approach for integrating heterogeneous sensor networks, in *International Conference on Body Area Networks BODYNETS*, London, Great Britain September 29–October 1, 2014
13. E.A. Kosmatos, N.D. Tselikas, A.C. Boucouvalas, Integrating RFIDs and smart objects into a unified internet of things architecture. *Adv. Int. Things: Sci. Res.* **1**, 5–12 (2011)
14. R. Aggarwal, M. Lal Das, RFID security in the context of “internet of things”, in *First International Conference on Security of Internet of Things*, Kerala, 17–19 August 2012, pp. 51–56 (2012)
15. L. Atzori, A. Iera, Morabito, G., The internet of things: a survey. *Comput. Netw.*, 2787–2805 (2010)
16. L. Coetzee, J. Eksteen, The internet of things—promise for the future? An introduction, in *Proceedings of the 2011 IST-Africa Conference; May 11–13, 2011; Gaborone, Botswana; IIMC International Information Management Corporation*, pp. 1–9 (2011)
17. S. Vongsingthong, S. Smachat, Internet of things: a review of applications & technologies. *Suranaree J. Sci. Technol.* **21**(4), 359–374 (2014)
18. O. Vermesan, P. Friess, *Internet of Things: Converging Technologies for Smart Environments and Integrated Ecosystems*. River Publishers Series In Communications, London, UK, 364p. (2013)

19. J. Gubbi, R. Buyya, S. Marusic, M. Palaniswami, Internet of things (IoT): a vision, architectural elements, and future directions. *FutureGener. Comp. Syst.* **29**, 1645–1660 (2013)
20. M.E. Ajana, M. Boulmalf, H. Harroud, M. Elkoutbi, RFID middleware design and architecture, in *Dr. Cristina Turcu, editor: Designing and Deploying RFID Applications*. Rijeka, Croatia: InTech; <https://doi.org/10.5772/16917> (2011)
21. S.M. Kywe, J. Shi, Y. Li, R. Kailash, Evaluation of different electronic product code discovery service model. *Adv. Int. Things (AIT)* **2**(2), 37–46 (2012)
22. ZIH Corp. Electronic Product Code (EPC) RFID Technology [Internet]. 2017. <https://www.zebra.com/us/en/resource-library/getting-started/rid-printing-encoding/epc-rid-technology.html>. Accessed 2 Oct 2018
23. Tutorials Point. Wi-Fi Wireless Communication [Internet]. 2015. www.tutorialspoint.com/wi-wii_tutorial.pdf. Accessed 2 Oct 2018
24. P.I. Bluetooth [Internet]. 2008. webuser.hs-furtwangen.de/~heindl/ebte-08ss-bluetooth-Ingo-Puy-Crespo.pdf [Accessed: 2 October 2018]
25. T. Obaid, H. Rashed, A. Abou-Elnour, M. Rehan, M. Muhammad-Saleh, M. Tarique, Zigbee technology and its application in wireless home automation systems: a survey. *Int. J. Comput. Netw. Commun.* **6**(4). <https://doi.org/10.5121/ijcnc.2014.6411> (2014)
26. S. Burkard, Near Field Communication in Smartphones [Internet]. https://www.snet.tu-berlin.de/fileadmin/fg220/courses/WS1112/snet-project/nfc-in-smartphones_burkard.pdf. Accessed 2 Oct 2018
27. K. Sohraby, D. Minoli, T. Znati, *Wireless Sensor Networks: Technology, Protocols, and Applications*. 1st ed. (John Wiley & Sons, Hoboken, NJ, 2017), pp. 38–69
28. Southwest Center for Microsystems Education (SCME) University of New Mexico. Introduction to Transducers, Sensors and Actuators [Internet] (2011). http://engtech.weebly.com/uploads/5/1/0/6/5106995/more_on_transducers_sensors_actuators.pdf. Accessed 2 Oct 2018
29. A. Al-Fuqaha, M. Guizani, M. Mohammadi, M. Aledhari, M. Ayyash, Internet of things: a survey on enabling technologies, protocols, and applications. *IEEE Commun. Surv. Tutor.* **17**(4), 2347–2376. <https://doi.org/10.1109/COMST.2015.2444095> (2015)
30. R. Khan, S.U. Khan, R. Zaheer, S. Khan, Future internet: the internet of things architecture, possible applications and key challenges, in *Frontiers of Information Technology (FIT), 10th International Conference on*, pp. 257–260 (2012)
31. Z. Yang, Y. Peng, Y. Yue, X. Wang, Y. Yang, W. Liu, Study and application on the architecture and key technologies for IOT, in *Multimedia Technology (ICMT), International Conference on*, pp. 747–751 (2011)
32. M. Wu, T.J. Lu, F.Y. Ling, J. Sun, H.Y. Du, Research on the architecture of internet of things, in *Advanced Computer Theory and Engineering (ICACTE), 3rd International Conference on*, pp. V5-484-V5-487 (2010)
33. L. Tan, N. Wang, Future internet: the internet of things, in *Advanced Computer Theory and Engineering (ICACTE), 2010 3rd International Conference on*, pp. V5-376-V5-380 (2010)
34. M.A. Chaqfeh, N. Mohamed, Challenges in middleware solutions for the internet of things, in *Collaboration Technologies and Systems (CTS), International Conference on*, pp. 21–26 (2012)
35. M.E. Ajana, H. Harroud, M. Boulmalf, M. Elkoutbi, A. Habbani, Emerging wireless technologies in e-health trends, challenges, and framework design issues, in *Proceedings of the International Conference on Multimedia Computing and Systems (ICMCS)*, 10–12 October, pp. 440–445 (2012)
36. M.E. Ajana, H. Harroud, M. Boulmalf, H. Hamam, FlexRFID: a lexible middleware for RFID applications development, in: *Proceedings of the 6th International Wireless and Optical Networks Communications (WOCN) Conference*; April; Cairo, Egypt (2009)
37. M.E. Ajana, H. Harroud, M. Boulmalf, M. Elkoutbi, FlexRFID middleware in the supply chain: Strategic values and challenges. *Int. J. Mobile Comput. Multimed. Commun.* **3**(2), 19–32 (2011). <https://doi.org/10.4018/jmcmc.2011040102>
38. E.M. Ajana, M. Chraibi, H. Harroud, M. Boulmalf, M. Elkoutbi, A. Maach, FlexRFID: a security and service control policy-based middleware for context-aware pervasive computing.

- Int. J. Adv. Res. Artif. Intell. (IJARAI). **3**(10). <https://doi.org/10.14569/ijarai.2014.031004> (2014)
39. S. Vongsingthong, S. Smanchat, Internet of things: a review of applications & technologies [Internet] (2014). <http://www.thaiscience.info/journals/Article/SJST/10966646.pdf>. Accessed 2 Oct 2018
 40. R. Li, H. Luo, Based on the internet of things the supermarket chain management information system development and safety stock research, in *Proceedings of the 2nd International Conference on Education Technology and Computer (ICETC)*; 22–24 June; Shanghai, China. pp. 368–371 (2010)
 41. Y. Wei, Design and realization of mobile information collection module in logistic internet of things unified information system, in *Proceedings of IEEE 3rd International Conference on Communication Software and Networks (ICCSN)*; 27–29 May; Xian, China. pp. 263–266 (2011)
 42. X. Lin, Logistic geographical information detecting unified information system based on internet of things, in *Proceedings of the 3rd International Conference on Communication Software and Networks (ICCSN)*; 27–29 May; Xian, China. pp. 303–307 (2011)
 43. Government Office for Science. The Internet of Things: Making the Most of the Second Digital Revolution [Internet]. www.gov.uk/government/uploads/system/uploads/attachment_data/file/409774/14-1230-internet-of-things-review.pdf. Accessed 2 Oct 2018
 44. A. Ghose, P. Biswas, C. Bhaumik, M. Sharma, A. Pal, A. Jha, Road condition monitoring and alert application: using in-vehicle Smartphone as internet-connected sensor, in *Proceedings of the IEEE 10th International Conference on Pervasive Computing and Communications (PERCOM Workshops)*; 19–23 March; Lugano, Switzerland. pp. 489–491 (2012)
 45. X. Ren, H. Jiang, Y. Wu, X. Yang, K. Liu, The Internet of things in the license plate recognition technology application and design, in *Proceedings of the Second International Conference on Business Computing and Global Informatization (BCGIN)*; 12–14 October; Shanghai, China. pp. 969–972 (2012)
 46. W. Haiying, H. Long, Q. Xin, W. Hongbo, L. Gechen, D. Xianqing, Simulation system of the performance of power battery for electrical vehicle based on Internet of things, in *Proceedings of the 2012 International Conference on Measurement, Information and Control (MIC)*; 18–20 May; Harbin, China. pp. 681–684 (2012)
 47. V.M. Rohokale, N.R. Prasad, R. Prasad, A cooperative internet of things (IoT) for rural health-care monitoring and control, in *Proceedings of the 2nd International Conference on Wireless Communication, Vehicular Technology, Information Theory and Aerospace & Electronic Systems Technology (Wireless VITAE)*; 28 February 3 March; Chennai, India. pp. 1–6 (2011)
 48. A.J. Jara, M.A. Zamora, A.F. Skarmeta, Knowledge acquisition and management architecture for mobile and personal health environments based on the internet of things, in *Proceedings of the IEEE 11th International Conference on Trust, Security and Privacy in Computing and Communications (TrustCom)*; 25–27 June; Liverpool, UK. pp. 1811–1818 (2012)
 49. M.T. Lazarescu, Design of a WSN platform for long-term environmental monitoring for IoT applications. *IEEE J. Emerg. Sel. Topics Circuits Syst.* **3**(1), 4554 (2013)
 50. M.U. Farooq, M. Waseem, S. Mazhar, A. Khairi, T. Kamal, A review on internet of things (IoT). *Int. J. Comput. Appl.* **113**(1). <https://doi.org/10.5120/19787-1571> (2015)
 51. M. Khan, B.N. Silva, K. Han, Internet of things based energy aware smart home control system. *IEEE Access* **4**, 7556–7566 (2016)
 52. R. Piyare, M. Tazil, Bluetooth based home automation system using cell phone, in *IEEE 15th International Symposium on Consumer Electronics* (2011)
 53. V.D. Bachuwar, A.D. Shligram, L.P. Deshmukh, Monitoring the soil parameters using IoT and android based application for smart agriculture, in *AIP Conference Proceedings 1989*, 020003, (2018); Vol. 1989, Issue 1. <https://doi.org/10.1063/1.5047679>, Published Online: 23 July 2018
 54. E. Ahmed, I. Yaqoob, I.A.T. Hashem, I. Khan, A.I.A. Ahmed, The role of big data analytics in internet of things. *Comput. Netw.* **129**, 459–471 (2017)
 55. Y.-S. Kang, I.-H. Park, J. Rhee, Y.-H. Lee, MongoDB-based repository design for IoT-generated RFID/sensor big data. *IEEE Sens. J.* **16**(2), 485–497 (2016)

56. H. Cai, B. Xu, L. Jiang, A.V. Vasilakos, Iot-based big data storage systems in cloud computing: perspectives and challenges. *IEEE Int. Things J.* **4**(1), 75–87 (2017)
57. L.D. Xu, W. He, S. Li, Internet of things in industries: a survey. *IEEE Trans. Ind. Informat.* **10**(4), 2233–2243 (2014)
58. D. El-Baz, J. Bourgeois, T. Saadi, A. Bassi, ALMA, a logistic mobile application based on Internet of Things, in: *Proceedings of the IEEE International Conference on Green Computing and Communications (GreenCom) and IEEE Internet of Things and IEEE Cyber, Physical and Social Computing*; 20–23 August; Beijing, China. pp. 355–358 (2013)
59. https://www.researchgate.net/figure/Four-dimensions-for-the-IoT-ITU_fig1_308711274

Evolution in Big Data Analytics on Internet of Things: Applications and Future Plan



Rohit Sharma, Pankaj Agarwal and Rajendra Prasad Mahapatra

Abstract The term Big Data shows the large and varied set of electronic information that can be the combination of data collected from multiple sources. Reliably, we make 2.5 quintillion bytes of facts; so much that 90% of the facts on earth nowadays has been made over the trendy two years alone. Security and surety problems are widely spreading out by using velocity, volume, and mixture of colossal records, as an example, generous scale cloud systems, varying characteristics of information sources and setups, spilling nature of information acquirement and high extent among cloud movements. IoT is a great idea for everyone and also the best path for innovation age. The IoT could play a very important role and be extensively delivered with the aid of the splendid amount of heterogeneous devices that produce critically “Huge information” (Lee et al. Research on iot based cyber physical system for industrial big data analytics. IEEE, pp. 1855–1859, [1]). As we know that a number of records are being gathered today through numerous associations and these records need a large storage, so how to accommodate a large memory space is also a big question in today scenario. It ends up being computationally wasteful to dissect any such huge data. The amount of the handy crude facts has been developing an exponential scale. A standout amongst the maximum vital highlights of IoT is its ongoing or close to constant correspondence of facts approximately the “connected matters”. The four precept peculiarity of IoT is (a) Large information degree (TBs to PBs), (b) High velocity of statistics circulation, information alternate (OLTP) and facts making ready (OLAP, examination) (c) Diverse prepared and unstructured information, differing information models and inquiry dialects, diverse facts resources and veracity (Rizwan et al. Real-time smart trafficmanagement systemfor smart cities by using internet of things and big data. IEEE, pp. 1–7, [2]). Big data and IoT are widely used in many applications worldwide. Many researchers are working day night to improve the services of Big data and IoT. There are many deficiencies are present in both the technologies. And the most common is its security. Big data and IoT both requires the concern about its security. The reason behind is that, the big data and IoT applications are accessing the use of cloud widely. And in many cases, the data

R. Sharma (✉) · P. Agarwal · R. P. Mahapatra
SRM Institute of Science and Technology, Ghaziabad, India
e-mail: rohitapece@gmail.com

© Springer Nature Singapore Pte Ltd. 2020
S. Tanwar et al. (eds.), *Multimedia Big Data Computing for IoT Applications*, Intelligent Systems Reference Library 163,
https://doi.org/10.1007/978-981-13-8759-3_18

453

stored to cloud is very secret. So from the security point of view, it is necessary to take these technologies seriously. Some researchers are also working on RFID and Internet of Things, like a combine approach. RFID is also a latest technology and due to its deficiencies, RFID technology is extracting out by many vendors. In UK, big numbers of RFID cards have been deployed in many places but it failed due to lacking in security. To improve RFID security, researchers are also having a look at IOT. The question is what the outcome will be. Will the researchers get success by using this combine approach? May be yes. In this chapter, some applications are discussed and try to explain the utilization of Big data and IoT in brief. Secondly, the deficiencies are also the matter of concern in the chapter. The desired solutions to overcome the drawbacks of the Big Data and Internet of Things are also discussed. This chapter is present about the development in the subject of Big Data on Internet of things applications.

Keywords IoT · Big data · IoT architecture · IoT in healthcare · Cloud computing in big data

1 Introduction

IoT paperwork is a speaking-actuating community of a massive quantity of things which includes RFID tags, cellular phones, sensors, and actuators, and so on. For many applications, we required a big storage to store the data. Because in some case the data is real time value that automatically update it after few moments. Like in health care system, the human body parameter is based on real time data. That will change after every moment. So here I am discussing about the same. The records generated from IoT have the subsequent features:

- Large-scale statistics: Masses of data acquisition gadget are allotted. For analysis and processing, now not most effective the presently received statistics.
- Effective statistics debts for most effective small part of large facts: a fantastic amount of noises can also occur throughout the purchase and transmission of statistics in IoT. In a few conditions, most effective small quantity of strange statistics is treasured [3, 4].

Big data and IoT are widely used in many applications worldwide. Many researchers are working day night to improve the services of Big data and IoT. There are many deficiencies are present in both the technologies. And the most common is its security. Big data and IoT both requires the concern about its security. The reason behind is that, the Big data and IoT applications are accessing the use of cloud widely [5]. The term Big Data shows the large and varied set of electronic information that can be the combination of data collected from multiple sources. Reliably, we make 2.5 quintillion bytes of facts; so much that 90% of the facts on earth nowadays has been made over the trendy two years alone. Security and surety problems are widely spreading out by using velocity, volume, and mixture of colossal records,

Table 1 Architecture using Five-layer for IoT

Layers	Description
Perception layer	Composed of physical gadgets and sensor devices
Network layer	In this layer, the usage of era may be Wi-Fi, Z-Wave, 3G, Zig-Bee and so forth
Middleware layer	For processing, storing, and studying the data of objects that obtained from the community layer and related to the database
Application layer	It is based on the objects statistics processed inside the middleware layer
Business layer	This layer is a manager of Internet of Things. The control includes programs, relevant device version, and services

as an example, generous scale cloud systems, varying characteristics of information sources and setups, spilling nature of information acquirement and high extent among cloud movements.

Internet of thing is very important for everyone in current scenario. It is widely useful in multiple applications like human healthcare systems, traffic monitoring systems and environments monitoring systems etc. The IoT can make the human life easier. The human health care system is widely used system that provides the online record of health for a person. The environment tracking system can help us to track the present environments condition for any location. The traffic intensity is also a big problem in current scenario. This problem can be solving out by using the Internet of thing. The traffic can be monitor and controlled with the help of IoT. Some researchers are also doing funded project of IoT. These projects will be very helpful for the society. So it is necessary to discuss about the recent trends of Internet of things.

Complex facts sorts generally in IoT applications can be represented and modeled extra successfully the usage of JSON (Java Script Object Notation) files, instead of tables. IoT may be divided into 5 layers as proven in Table 1.

2 Recent Trends in IoT-Based Analytics and Big Data

Lot of applications recently comes in trend that links to Big data and IoT. It is very important to learn and discuss about these recent trends. Today, many applications are directly or indirectly linked to Big data and IoT. Big Data are widely used in many applications worldwide. Many researchers are working day night to improve the services of Big data and IoT. There are many deficiencies are present in both the technologies. And the most common is its security. Big data and IoT both requires the concern about its security. The reason behind is that, the big data and IoT applications are accessing the use of cloud widely. Out of these, the use of IoT in healthcare, home security, human tracking are widely acceptable by the world. Yes, while we are talking about the benefits of a technology then few drawbacks and sophisticated issue are also

being in concern. Some researchers are also working on RFID and Internet of Things, like a combine approach. RFID is also a latest technology and due to its deficiencies, RFID technology is extracting out by many vendors. In UK, big numbers of RFID cards have been deployed in many places but it failed due to lacking in security. To improve RFID security, researchers are also having a look at IOT. The question is what the outcome will be. Will the researchers get success by using this combine approach? May be yes. Internet of thing is very important for everyone in current scenario. It is widely useful in multiple applications like human healthcare systems, traffic monitoring systems and environments monitoring systems etc. The IoT can make the human life easier. The human health care system is widely used system that provides the online record of health for a person. The environment tracking system can help us to track the present environments condition for any location. The traffic intensity is also a big problem in current scenario. This problem can be solving out by using the Internet of thing. The traffic can be monitor and controlled with the help of IoT. Some researchers are also doing funded project of IoT. These projects will be very helpful for the society. So it is necessary to discuss about the recent trends of Internet of things.

In this chapter, some applications are discussed and try to explain the utilization of Big data and IoT in brief. Secondly, the deficiencies are also the matter of concern in the chapter. The desired solutions to overcome the drawbacks of the Internet of Things and Big Data are also discussed. This chapter is present about the development in the subject of Big Data on Internet of things applications. So in this chapter I am discussing about these advantages along with few drawbacks of Big data and IoT [6]. The term Big Data shows the large and varied set of electronic information that can be the combination of data collected from multiple sources. Reliably, we make 2.5 quintillion bytes of facts; so much that 90% of the facts on earth nowadays has been made over the trendy two years alone. Security and surety problems are widely spreading out by using velocity, volume, and mixture of colossal records, as an example, generous scale cloud systems, varying characteristics of information sources and setups, spilling nature of information acquirement and high extent among cloud movements. Here I am trying to share few reviewed papers on Big data and IoT. I consider few researchers' views. They are sharing their ideas in the field of Big data and IoT. The concept and logic are different but the target is same how analyze the performance of Big data and IoT.

Alam et al. [7] Have a study that has an applicability of 8 facts mining algorithms, inclusive of KNN, SVM, NB, C5, Zero, C4, Five, linear discriminate evaluation (LDA), synthetic neural community (ANN), and ANN (DLANN), deep studying for IoT-generated statistics.

Lee et al. [1] Propose an Internet of Things-based completely cyber physical gadget that helps information evaluation and information acquisition techniques to enhance productivity in sever industries.

Rathore et al. [4] Advocate a clever town manage gadget based totally mostly on Internet of Things that exploits analytics and big data. The records are amassed by using deploying specific sensors, including water sensors and weather, surveillance gadgets, vehicular networking sensors. The proposed model is carried out the usage of

the Map Reduce Hadoop environment in a actual environment. The implementation technique consists of sever steps, together with information era, statistics amassing.

Rizwan et al. [2] Have an example that the weaknesses and strengths of numerous visitors control systems. They recommend a low value, actual-time visitors control machine that deploys sensors and IoT devices to seize actual-time site visitors information. Specifically, low-price web site sensors for traffic detection are installed within the center of the street for each 500 or one thousand meters. Compared with the existing structures, the proposed device offers a higher alternative technique for coping with web page site visitors.

Zhang et al. [3] Endorse Firework, a contemporary computing paradigm that permits dispensed facts sharing and processing in an Internet of Things based totally, collaborative region environment. Firework combines bodily allotted information through manner of supplying digital statistics perspectives to give up customers using predefined interfaces. Firework instance has many stakeholders who should sign in their corresponding features and datasets which are abstracted as records perspectives. They illustrate such concept through the usage of appearing case studies of linked health and locate the misplaced.

Ahlgren et al. [5] talks the importance of using Internet of things to deliver services for enhancing the lives of residents, which include air excellent, transportation, and strength overall performance. The authors explain that Internet of things based totally systems need to be primarily based on open facts and requirements, including protocols and interfaces, to permit 0.33- birthday celebration innovations through way of mitigating producer lock-ins.

Wang et al. [8] discusses the possibilities and challenges because of IoT and big statistics for the cluster of maritime. They also boom a modern day framework for integrating business Internet of things with massive information and analytics generation.

Sezer et al. [9] proposes a model that integrates massive statistics, semantic net technology, and Internet of things. The key necessities for the proposed model are the conceptual and analyzed format of the predicted Internet of things gadget is proposed based at the analysis consequences. The logical model deals with 5 layers, especially, extract-rework-load (ETL), data acquisition, semantic rule reasoning, analyzing, and motion.

Prez and Carrera [6] conclude a comprehensive study at the overall characterization performance of the IOT. They specifically reputation on the contemporary day infrastructure for website hosting Internet of things loads in the cloud with a goal to provide multi-tenant facts move advanced querying mechanisms, processing abilities, software answers through combining superior information-centric generation and multi-protocol help.

Jara et al. [10] discusses a survey to spotlight the prevailing answers and demanding situations to big data which can be posed thru cyber-physical structures. There have a look at makes a specialty of cloud safety and the heterogeneous integration of information from a couple of assets.

Vuppalapati et al. [11] Examine the function of large statistics in health system and find out that sensors for body generate massive amounts of fitness related information.

Ding et al. [12] Recommend a contemporary cluster mechanism for statistical database for massive statistics analysis in the (IOT-Statistic DB) IoT paradigm. The statistical evaluation is completed in a disbursed and parallel fashion the usage of more than one server.

Yen et al. [13] look at the capability of service composition techniques and discovery in fixing actual-worldwide issues primarily based at the statistics generated via IoT. They look at how diverse technology, consisting of statistics artificial intelligence and analytics can be used inside the clever global to derive situational information and to take moves therefore.

Ahmad et al. [14] makes analysis on the behavior of human by the usage of the use of huge facts and analytics inside the social IoT paradigm. They recommend an structure that contains three domains.

Arora et al. [15] Make use of huge records and analytics strategies to categories network-enabled gadgets. They additionally examine the general overall performance of four gadget studying algorithms, which include good Nave Bayes (NB), enough-nearest neighbor (KNN), random forest and manual vector machines (SVM).

Minch et al. [16] Perform few studies about place privateness within the generation of IoT, huge data, and analytics. They come to be privy to, describe and classify privateness issues and display the viable ache elements inside the context of huge information and analytics.

Mukherjee et al. [17] Endorse an Internet of things model for the execution of facts parallel analytic jobs. They aim to turn out to be aware of a appropriate analytical set of rules that would cope up with the necessities of processing and reading large quantities of statistics.

Ramakrishnan et al. [18] Analyze the contemporary energy improvement in India and determine the blessings that may be received via analytics and cloud computing.

Berlian et al. [19] Introduce a model for tracking and studying massive quantities of information that are generated via the (IoUT) Internet of Underwater Things.

Mourtzis et al. [20] Display that the adoption of Internet of things within the manufacturing enterprise can remodel conventional systems into contemporary ones. Moreover, such transformation results in a records production manner that turns commercial information into commercial enterprise large statistics, which is probably rendered vain without analytics power. The term Big Data shows the large and varied set of electronic information that can be the combination of data collected from multiple sources. Reliably, we make 2.5 quintillion bytes of facts; so much that 90% of the facts on earth nowadays has been made over the trendy two years alone. Security and surety problems are widely spreading out by using velocity, volume, and mixture of colossal records, as an example, generous scale cloud systems, varying characteristics of information sources and setups, spilling nature of information acquirement and high extent among cloud movements. Big data and IoT are widely used in many applications worldwide. Many researchers are working day night to improve the services of Big data and IoT. There are many deficiencies are present in both the technologies. And the most common is its security. Big data and IoT both require the concern about its security [21].

And in many cases, the data stored to cloud is very secret. Some researchers are also working on RFID and Internet of Things, like a combine approach. RFID is also a latest technology and due to its deficiencies, RFID technology is extracting out by many vendors. In UK, big numbers of RFID cards have been deployed in many places but it failed due to lacking in security. To improve RFID security, researchers are also having a look on IOT. The question is what outcome will be. In this chapter, some applications are discussed and try to explain the utilization of Big data and IoT in brief. Secondly, the deficiencies are also the matter of concern in the chapter. The desired solutions to overcome the drawbacks of IoT and bog data are also discussed.

3 The Need of Big Data and IoT Implementation

IoT will permit massive records, large facts needs analytics, and analytics will enhance procedures for greater IoT gadgets. The parent below suggests the regions of massive facts produced. Some or the alternative way, facts is produced through connected devices [22].

Figure 1 show the different areas relates to big data. Figure shows that, how the different technologies are connected to each other in big data.

- Analytical monitoring
- Enable mass customization
- Improved situational alertness
- Safety enhancements
- Process optimization

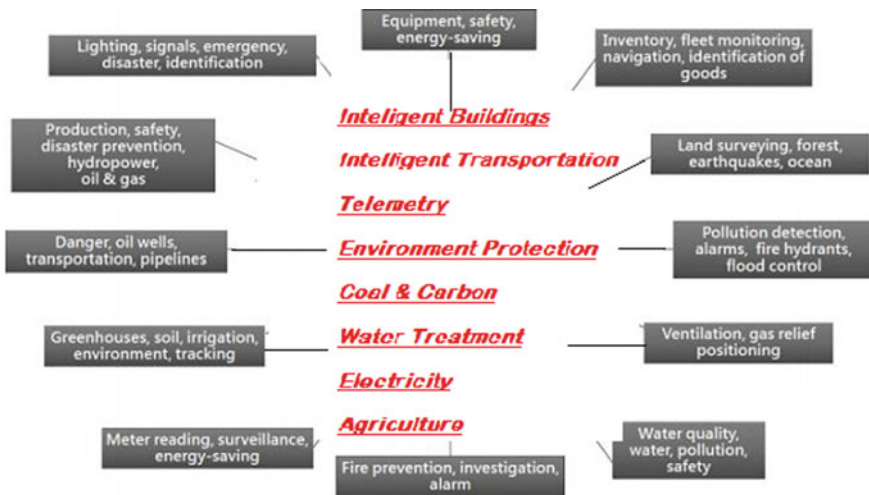

Fig. 1 Various areas relates to Big data

- Labor Efficient use
- Optimized resource utilization
- Improved quality

The above are few viable motives to put in force Big data and IoT.

4 IoT Impacts on Big Data

Internet of Things is a network including devices (physical), which can be additionally implanted with electronics, software and sensors thereby allowing those gadgets to trade records. This surely allows good incorporation among actual world bodily entities and laptop-operated systems. The term Big Data shows the large and varied set of electronic information that can be the combination of data collected from multiple sources. Reliably, we make 2.5 quintillion bytes of facts; so much that 90% of the facts on earth nowadays has been made over the trendy two years alone. Security and surety problems are widely spreading out by using velocity, volume, and mixture of colossal records, as an example, generous scale cloud systems, varying characteristics of information sources and setups, spilling nature of information acquirement and high extent among cloud movements. Lot of applications are recently comes in trend that links to Big data and IoT. It is very important to learn and discuss about these recent trends. Today, many applications are directly or indirectly linked to Big data and IoT. Out of these, the use of IoT in healthcare, home security, human tracking are widely acceptable by the world. Yes, while we asking about the advantages of any technology then few drawbacks and sophisticated issue are also be present there. So in this chapter I am discussing about these advantages along with few drawbacks of Big data and IoT [23].

The term Big Data shows the large and varied set of electronic information that can be the combination of data collected from multiple sources. Reliably, we make 2.5 quintillion bytes of facts; so much that 90% of the facts on earth nowadays has been made over the trendy two years alone. Security and surety problems are widely spreading out by using velocity, volume, and mixture of colossal records, as an example, generous scale cloud systems, varying characteristics of information sources and setups, spilling nature of information acquirement and high extent among cloud movements. Big data and IoT are widely used in many applications worldwide. Many researchers are working day night to improve the services of Big data and IoT. There are many deficiencies are present in both the technologies. And the most common is its security. Big data and IoT both require the concern about its security.

a. Issues of Security for data

The Internet of things has given new protection demanding situations that cannot be controlled by way of using conventional protection techniques. Big data and IoT are widely used in many applications worldwide. Many researchers are working day night to improve the services of Big data and IoT. There are many deficiencies are

present in both the technologies. And the most common is its security. Big data and IoT both requires the concern about its security. The reason behind is that, the Big data and IoT applications are accessing the use of cloud widely. In UK, big numbers of RFID cards have been deployed in many places but it failed due to lacking in security. To improve RFID security, researchers are also having a look at IOT. The question is what the outcome will be. Will the researchers get success by using this combine approach? May be yes. In this chapter, some applications are discussed and try to explain the utilization of Big data and IoT in brief. Secondly, the deficiencies are also the matter of concern in the chapter. The desired solutions to overcome the drawbacks of the Internet of Things and Big Data are also discussed. This chapter is present about the development in the subject of Big Data on Internet of things applications. So in this chapter I am discussing about these advantages along with few drawbacks of Big data and IoT [6]. Facing IoT safety troubles require a shift. Few security troubles are

- Secure filtering of redundant statistics
- Secure statistics facilities
- Secure transactions
- Access manage
- Imposing real time protection, and so on.,

A multi-layered protection device and proper network tool will assist avoid attacks and maintain them from scattering to different elements of the community.

b. Storage for Big Data

Obviously Internet of things has an instantaneous impact at the storage infrastructure of massive facts. For many applications, we required a big storage to store the data. Because in some case the data is real time value that automatically update it after few moments. Like in health care system, the human body parameter is based on real time data. That will change after every moment. So here I am discussing about the same. The records generated from IoT have the subsequent features: Collection of Internet of things Big Data is a difficult assignment because filtering redundant facts is necessarily required [24].

c. Year by year living Impact:

At domestic, the dwelling theatre gambling the favorite film of ours as rapid as you flip on the TV, clever gadgets could have got to shop plenty of power and cash through robotically switching off electric devices even as you go away domestic.

The above mentioned goes to reveal up in a fully temporary time given that of the fast improvement in web of things and large information science [25].

d. Analytics of Big Data:

IoT significant knowledge analytics may also be very needed to grow to be in a optimized decision. Consistent with the Gartner IT dictionary, massive information is style of know-how belongings, immoderate-quantity, and immoderate-pace and progressive forms of records processing for higher approach and option making

[26]. The term Big Data shows the large and varied set of electronic information that can be the combination of data collected from multiple sources. Reliably, we make 2.5 quintillion bytes of facts; so much that 90% of the facts on earth nowadays has been made over the trendy two years alone. Security and surety problems are widely spreading out by using velocity, volume, and mixture of colossal records, as an example, generous scale cloud systems, varying characteristics of information sources and setups, spilling nature of information acquirement and high extent among cloud movements [6].

The charge at which expertise streams in from property along with cellular items; click on streams, gadget-to-method approaches is giant and constantly fast transferring. Significant know-how mining and analytics makes it possible for to reveal secret patterns, unidentified correlations, and specific manufacturer documents [11].

5 Internet of Things Applications

The IoT is anything but an all around coordinated statute. It is an application time and valuable to our life. There exist some effective projects officially progressed in exceptional fields like transportation, astute situations territory, wellness care put, dinner's manageability, and advanced applications [27].

a. Transportation

- **Brilliant stopping**

The brilliant stopping gives answers for control of stopping that can assist drivers with keeping time and gas. By providing right information about vehicles stopping territories, it will be valuable for improving site guests float and abatement site guests stick [28].

- **Three-D Assisted driving**

Vehicles like autos, transports and prepares which is presumably furnished with sensors can supply gainful data to the main impetus to keep better route and wellbeing. By utilizing 3D helped utilizing, the drivers can decide the right course in view of on prior comprehension about guests stick and mischance's [12].

b. Shrewd conditions

- **Shrewd houses and work environments**

Sensors, controllers and actuators might be added to various residential and authoritative focus gadgets as a fan, icebox, clothes washer, forced air system, and microwave. For instance in Turkey, they watch a product for a residential that is a response for masses issues [29].

- **Brilliant water supply**

Water supply in sharp urban communities needs to be followed to guarantee that the water amount is sufficient for ways of life wishes. The keen urban

areas might be fit for find water misfortune bother sooner than it takes area, thus it can broadly keep on the value assortment. It enables the sharp urban areas to find the water spill sites and select out change priority to keep parts measure of water from misfortune.

c. **Medicinal services**

- **Pharmaceutical stock**

Keen drug store is a perfect program that enables smooth gets to treatment. Sensors associated devices can show the use of the medicine. On account of finding terminated pills, it will keep it from gets to the influenced individual. For instance, keen physician recommended drugs is a South African venture that gives a settled of over the top abilities, low-charge pharmaceuticals to drug stores, specialists, and extraordinary human services social orders.

- **Wellbeing following**

Radio Frequency Identification (RFID) age is valuable for screen character's wellness. The influenced man or lady's restorative insights might be estimated by means of detecting gadgets and dispatched remotely to his to seek after his wellness [30].

d. **Advanced projects**

The applications noted inside the past segments are commonsense as they both were at that point conveyed or might be expert in a short or medium period considering the predefined time are now accessible. The following noted applications aren't done; it'll see inside what's to come.

e. **Sustenance manageability**

There are various stages that crosses from it before setting into the ice chest. These extents are fabricating, collecting, transportation, and dissemination. The sustenance can be put away from harm through the utilization of sensors that ready to show the fame of the nourishment and track temperature, mugginess, and light to safeguard nourishment. Powerful dinners checking let in plant security from damage and oversee water sum [31].

City data variant

The (CIM) City Information Model is based on the conviction that recommends all homes is followed by means of the experts and permitted to the third birthday festivity. Can obviously interconnect with every uncommon. Shrewd urban areas models must be incorporated to improve execution and effectiveness of the gadget [18].

Taxi using Robot

Savvy robot taxis in brilliant urban communities can address with each other and offer contributions while solicited by route from people. Robot cabs can treat without issues with activity blockage. On account of ceasing in the meantime as sensors told that actuators start off energizing batteries, it can make straightforward safeguarding and smooth the vehicle.

6 Methodologies and Techniques

Lot of methodologies and techniques are available for improving the services of Big data and IoT. Few of them, we are going to discuss here (Fig. 2).

a. Map Reduce:

Map Reduce move toward becoming built as a broad programming worldview. A portion of the valid jobs provided all the key wants of parallel execution, adaptation to internal failure, stack adjusting, and data control. The Map Reduce structure accumulates all gadgets with the not strange key from all information and goes along with them by and large. Hence, it secures shaping one business endeavor for every last one of the super created keys. Map Reduce is one of the new age, anyway it's far obviously an arrangement of rules, a strategy for the best approach to fit as a fiddle the majority of the insights. To accumulate the awe inspiring from Map Reduce, we need more noteworthy than only a calculation. We need an arrangement of items and innovations made to control the difficulties of Big data [33].

b. Hadoop:

Hadoop is proposed to parallelize records preparing through processing hubs to surge calculations and shroud idleness. Map Reduce is a structure that is utilized for handling enormous records sets in an assigned style through various machines [34].

c. Pig:

The Pig usage planned in the Hadoop structure to offer additional database as ability. A work area in Pig is a settled of tuples, and each issue is a rate or an arrangement of tuples. Along these lines, this structure takes into consideration settled tables, that is a surprising conviction. Pig additionally offers a scripting dialect known as

Fig. 2 Hadoop ecosystem of Apache [32]

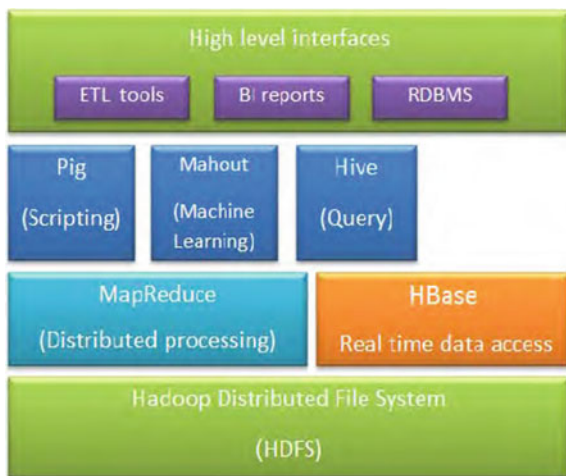

Pig Latin that gives the majority of the not unordinary ideas of SQL, together with projections, joins, arranging, and gathering. Pig Latin contrasts from SQL as contents are procedural and are perfect for software engineers to be comprehended [29].

d. **HBase:**

HBase is a database show inside the Hadoop structure that resembles the first gadget of Big Table. The records in HBase are similarly spared as (key, rate) gadgets, wherein the mission inside the non-key segments might be spoken to by the qualities.

e. **Mahout:**

Mahout is particularly built on an Apache open-convey library which ready to be scaled and overseen for the huge amount of realities. These fragments rely upon three full-estimate framework considering missions that Mahout as of now works.

- Collaborative separating
- Clustering
- Categorization/Classification.

f. **NoSQL:**

In light of the blast of the Internet ease of use and the openness of minimal effort stockpiling, a major amount of built up, semi-set up and unstructured certainties are obtained and put something aside for sublime styles of bundles. This measurement is usually signified to as big records. Google, Facebook, Amazon, and severa uncommon organizations utilize NoSQL databases [35].

g. **GFS:**

GFS is an assigned report gadget set up by methods for Google Inc. GFS is more suited for Google's most imperative realities stockpiling and use prerequisites which can create huge parts of insights that calls for reviewing. GFS has numerous capacities, which incorporate conventional in general execution, adaptability, dependability, and accessibility of the apportioned report framework controlled through way of utility outstanding tasks at hand and innovative condition of Google [30].

h. **Big Table:**

A Big Table improvement is started in 2004 and is presently used by a far of Google applications, all in all with Map Reduce.

Big Table is enlarged for insights take a gander at procedures, by utilizing method for allocated data carport control demonstrate, it truly is basically founded for the most part on segment stockpiling to finish information recovering viability [20]. The term Big Data shows the large and varied set of electronic information that can be the combination of data collected from multiple sources. Reliably, we make 2.5 quintillion bytes of facts; so much that 90% of the facts on earth nowadays has been made over the trendy two years alone. Security and surety problems are widely spreading out by using velocity, volume, and mixture of colossal records, as an example, generous scale cloud systems, varying characteristics of information

sources and setups, spilling nature of information acquirement and high extent among cloud movements. Big data and IoT are widely used in many applications worldwide. Many researchers are working day night to improve the services of Big data and IoT. There are many deficiencies are present in both the technologies. And the most common is its security. Big data and IoT both require the concern about its security [36].

i. **Ontology**

Metaphysics is the focal point of any semantic time as semantic sensor Web. It is a gadget for data designations and use. Semantic Ontology might be separated into a couple of codecs as OWL and RDF.

j. **Semantic Sensor Web**

The measure of blessing sensors can be full-estimate, and the aggregated information might be escalated. On the off chance that we've the capacity to put the accumulations of records legitimate into a homogeneous and heterogeneous frame, at that point the interoperability issues of insights the information will depend upon the semantic advancements to device the data. There are numerous components of semantic sensor Web as [31]:

k. **RDF:**

RDF is a shortening for portrayal considers structure. It is an investigations depiction dialect. This dialect decides the manner in which that sources can interconnect with each unique and perform understandings.

l. **Data Fusion**

It is a multidisciplinary volume that incorporates server fields, and it is hard to discharge an unmistakable and specific class. The created systems and methods can be partitioned as said through the accompanying prerequisites:

- According to the particular records combination levels said by method for the utilization of the JDL.
- According to the structure kind: (a) concentrated, (b) decentralized, or (c) dispensed.

In the accompanying subsections, a couple of IoT middleware proposition are ordered:

UBIWARE

The middle thoughts of UBIWARE is to allow computerized revelation, organization, movement, summon and execution of different Business Intelligence contributions.

Connection Smart Middleware

Connection Smart is predicated on a semantic model-driven design and allows the utilization of gadgets as administrations each with the valuable asset of inserting contributions in gadgets and with the asset of intermediary administrations for gadgets. The semantic depiction of gadgets depends on ontology the utilization of OWL, SAWSDL and OWL-s [24].

Hydra

The Hydra middleware incorporates of a transporter arranged shape. It relies upon Web contributions to help the asset revelation, depiction, and get passage to that depends absolutely on XML and Web conventions. Hydra people group utilizes an intermediary to join the limited gadgets to it. The two standard obligations wrapped up by method for Hydra developers are (I) incorporating non-Hydra gadgets and (ii) interfacing Hydra-empowered contraptions to a system.

7 Cloud Computing and Big Data Analytics for IOT

Big data and IoT are widely used in many applications worldwide. Many researchers are working day night to improve the services of Big data and IoT. There are many deficiencies are present in both the technologies. And the most common is its security. Big data and IoT both require the concern about its security. The reason behind is that, the Big data and IoT applications are accessing the use of cloud widely. The term Big Data shows the large and varied set of electronic information that can be the combination of data collected from multiple sources. Reliably, we make 2.5 quintillion bytes of facts; so much that 90% of the facts on earth nowadays has been made over the trendy two years alone. Security and surety problems are widely spreading out by using velocity, volume, and mixture of colossal records, as an example, generous scale cloud systems, varying characteristics of information sources and setups, spilling nature of information acquirement and high extent among cloud movement [15] (Table 2).

Map Reduce is a processing version and programming in big statistics. Some Map Reduce initiatives and related software program are shown in Table 3.

Web of Things has been advanced in one of a kind districts and states in 3 principal designs and probabilities financing strategy. In the states together with the USA, the brief timeframe period respect fund weight of the advancement of cunning power, sharp towns, and RFIDs. Through the online life arrange, a couple of administrations, and bundles, together with locale based absolutely contributions, expanded truth, and cell phones, are primary to the advancement of Internet of Things. Despite the fact that it isn't in every case yet evident which procedure is all the more ground-breaking, every one of them can support Internet of Things and its projects. Be that as it may, an approach to decide the endeavors of accessible sources at an arranged level obtains each other task [26].

Joining big statistics with conventional statistics is any other path to value. For instance, so-referred to as 360-diploma perspectives of clients and different business entities are extra entire and larger whilst based totally on both traditional business enterprise records and large records [13]. Big data and IoT are widely used in many applications worldwide. Many researchers are working day night to improve the services of Big data and IoT [37]. There are many deficiencies are present in both the technologies. And the most common is its security. Big data and IoT both requires the concern about its security. The term Big Data shows the large and varied set of

Table 2 Classification for Big data

Classification	Description
Data sources	<ul style="list-style-type: none"> • Web and Social: Generating information thru URL to share or change facts in digital communities and networks, consisting of blogs, Facebook, and Twitter
	<ul style="list-style-type: none"> • Machine: automatically producing information from computer systems, medical devices, or other machines
	<ul style="list-style-type: none"> • Sensing: producing information from sensing devices
	<ul style="list-style-type: none"> • Transactions: Transaction statistics, consisting of monetary and paintings statistics
	<ul style="list-style-type: none"> • IoT: Internet of things produces huge amounts of statistics
	<ul style="list-style-type: none"> • Semi-structured: not following a conventional database device; within the form of structured facts that are not prepared in relational database fashions
	<ul style="list-style-type: none"> • Unstructured: along with textual content messages, movies, and social media information; now not following a designated layout
Data stores	<ul style="list-style-type: none"> • Document-oriented: A document-orientated information save is much like a document or row in a database type relational
	<ul style="list-style-type: none"> • Graph primarily based: storing and representing records that make use of a graph model with nodes, edges, and houses related to each other through members of the family
	<ul style="list-style-type: none"> • Key-value: Key-cost is an opportunity relational database device that shops and accesses records designed to scale to a very big length
Data staging	<ul style="list-style-type: none"> • Cleaning: identifying incomplete and unreasonable facts
	<ul style="list-style-type: none"> • Transform: remodeling data into a form appropriate for evaluation
Data processing	<ul style="list-style-type: none"> • Batch: Map Reduce-primarily based structures were followed for lengthy-going for walks batch jobs
	<ul style="list-style-type: none"> • Real time: including easy scalable streaming system (S4)

Table 3 Some related software and Map Reduce projects

Software	Brief description
Hive	Offers a HDFS warehouse structure
Hbase	Scalable distributed database assisting based statistics garage for big tables
Spark™	A speedy computation engine for Hadoop statistics
Cassandra	A scalable multi-master database without a single factor of failure
Zookeeper™	High-performance provider to coordinate the approaches of allotted programs; a distributed carrier with grasp and slave nodes and stores configuration facts
Madout™	A device-studying and information-mining library that can be completed in a allotted mode and is executable via Map Reduce

Table 4 Big data IoT management subsystem

Layers	Management subsystems
Layer 1	IoT objects management (physical devices)
Layer 2	IoT big-data management
Layer 3	IoT intelligence management
Layer 4	IoT applications management

Table 5 Overall big data IoT layering architecture

Layering	Architecture representation
Application layer	IoT applications
Knowledge processing layer	IoT tools
Data management layer	IoT middleware
Transport layer	IoT network
Physical sensing layer	IoT objects

electronic information that can be the combination of data collected from multiple sources. Reliably, we make 2.5 quintillion bytes of facts; so much that 90% of the facts on earth nowadays has been made over the trendy two years alone. Security and surety problems are widely spreading out by using velocity, volume, and mixture of colossal records, as an example, generous scale cloud systems, varying characteristics of information sources and setups, spilling nature of information acquirement and high extent among cloud movements [6].

In UK, big numbers of RFID cards have been deployed in many places but it failed due to lacking in security. To improve RFID security, researchers are also having a look at IOT. The question is what the outcome will be. Will the researchers get success by using this combine approach? May be yes. In this chapter, some applications are discussed and try to explain the utilization of Big data and IoT in brief. Secondly, the deficiencies are also the matter of concern in the chapter. The desired solutions to overcome the drawbacks of the Internet of Things and Big Data are also discussed. This chapter is present about the development in the subject of Big Data on Internet of things applications. So in this chapter I am discussing about these advantages along with few drawbacks of Big data and IoT [6].

An information type procedure is anticipated to formulate fused information into more than one fact groups [31]. The fused information can be labeled into more than one businesses of having more than one occasion kinds inclusive of system popularity records, functional facts, inventory records, manufacturing facts, and product great information, etc. [16, 27] (Tables 4 and 5).

IoT will power Big Data by way of supplying extra information, from many distinct resources, in real-time. Big Data has few key skills for records management in IoT:

- Creating rich and useful packages: Data control have to aid the improvement of functionally wealthy packages with complicated information and algorithms [15].

- Unlocking commercial enterprise agility: The potential to aid many new and regularly converting business necessities.
- Enabling a unmarried point of truth and commercial enterprise convergence: Aggregate more than one views of associated facts from multiple structures into one constant version of the facts [38].

The product of huge simple insights is the antecedent to the upward push of the (IIoT) Industrial Internet of Things. By making machines more quick witted by means of neighborhood preparing and discussion, the IIoT will resolve inconveniences in systems which have been some time ago impossible [35]. This is in which enormous records investigation (BDA) will coordinate in. Indeed, BDA and IoT supplement each uncommon and increment as a twofold “helix”. BDA on sensor-empowered task records can upgrade vitality execution and natural generally speaking execution, assurance confirmation and assessment, and the following of wounds and condition dangers. In standard, BDA requires overwhelming computational quality. As people have decided in the HPC arrange, super pc frameworks have just been worked with a half and half CPU and GPU structure to use the huge pool of preparing contraptions in GPUs [30].

Web of Things has been advanced in one of a kind districts and states in 3 principal designs and probabilities financing strategy. In the states together with the USA, the brief timeframe period respect fund weight of the advancement of cunning power, sharp towns, and RFIDs. Through the online life arrange, a couple of administrations, and bundles, together with locale based absolutely contributions, expanded truth, and cell phones, are primary to the advancement of Internet of Things. Despite the fact that it isn't in every case yet evident which procedure is all the more ground-breaking, every one of them can support Internet of Things and its projects. Be that as it may, an approach to decide the endeavors of accessible sources at an arranged level obtains each other task [26].

A comprehensive Big Data approach changed into proposed to uncover the not bizarre direction from tremendous RFID-empowered creation realities for supporting assembling coordinations decision makings. This system includes several key advances: warehousing for crude RFID information, purging instrument for RFID enormous certainties, mining not strange examples, and also test elucidation and representation. For IoT programs, they got substantial detecting records might be in various abilities, that is a test. Enormous Data investigation has been vast heterogeneous records examination in nonlinear, high-dimensional, dispensed, and parallel insights handling. In Big Data procedures for IoT, a calculation changed into proposed for peculiarity discovery in enormous sensor actualities. Big data and IoT are widely used in many applications worldwide. Many researchers are working day night to improve the services of Big data and IoT. There are many deficiencies are present in both the technologies. And the most common is its security. Big data and IoT both requires the concern about its security. The reason behind is that, the Big data and IoT applications are accessing the use of cloud widely. In exact, an arrangement of tenets of relevant inconsistency location moved toward becoming conveyed to improvement a thing abnormality recognition set of principles. A post-preparing

setting cognizant irregularity location algorithm changed into proposed in light of on a multivariate grouping set of directions. A Map Reduce technique turned out to be moreover proposed to characterize the sensor profiles utilized in the setting locator [33, 39].

8 Future Directions and Challenges of Internet of Things

The Internet of Things is offers various new conceivable outcomes to the venture and end shopper in loads of programming fields. Lot of applications are recently comes in trend that links to Big data and IoT. It is very important to learn and discuss about these recent trends. In UK, big numbers of RFID cards have been deployed in many places but it failed due to lacking in security. To improve RFID security, researchers are also having a look at IOT. The question is what the outcome will be. Will the researchers get success by using this combine approach? May be yes. In this chapter, some applications are discussed and try to explain the utilization of Big data and IoT in brief. Secondly, the deficiencies are also the matter of concern in the chapter. The desired solutions to overcome the drawbacks of the Internet of Things and Big Data are also discussed. The term Big Data shows the large and varied set of electronic information that can be the combination of data collected from multiple sources. Reliably, we make 2.5 quintillion bytes of facts; so much that 90% of the facts on earth nowadays has been made over the trendy two years alone. Security and surety problems are widely spreading out by using velocity, volume, and mixture of colossal records, as an example, generous scale cloud systems, varying characteristics of information sources and setups, spilling nature of information acquirement and high extent among cloud movements. This chapter is present about the development in the subject of Big Data on Internet of things applications. So in this chapter I am discussing about these advantages along with few drawbacks of Big data and IoT [6]. Today, many applications are directly or indirectly linked to Big data and IoT. Internet of thing is very important for everyone in current scenario. It is widely useful in multiple applications like human healthcare systems, traffic monitoring systems and environments monitoring systems etc. The IoT can make the human life easier. The human health care system is widely used system that provides the online record of health for a person. The environment tracking system can help us to track the present environments condition for any location. The traffic intensity is also a big problem in current scenario. This problem can be solving out by using the Internet of thing. The traffic can be monitor and controlled with the help of IoT. Some researchers are also doing funded project of IoT. These projects will be very helpful for the society. So it is necessary to discuss about the recent trends of Internet of things.

Out of these, the use of IoT in healthcare, home security, human tracking are widely acceptable by the world. Yes, while we asking about the advantages of any technology then few drawbacks and sophisticated issue are also be present there. So

in this chapter I am discussing about these advantages along with few drawbacks of Big data and IoT [33].

a. Challenge of Environment Innovation:

Web of Things is a muddled system that is most likely executed with the guide of a few supporters, in which administrations should be audaciously delivered. In this way, new administrations or projects must be upheld without coming about hundreds for the commercial center gets to or other task squares. In this way, the move-area frameworks helping advancement keeps on being poor [40].

b. Challenge of Architecture:

Web of Things covers a serious sort of innovation. Web of Things comprises of a combined scope of cunning interconnected contraptions and sensors alongside cameras, biometric, substantial, and concoction sensors [41]. They are frequently nonintrusive, seen, and covered up.

c. Challenge of Technical Protocols:

There are a few specialized requesting circumstances as Heterogeneous design inside the network innovation and applications. Web of Things comprises of unmistakable sorts of systems that are not smooth to coordinate them. The cost of report age should be little and associations must be dependable. Characterizing the type of proper wellbeing and privateness answer is an entangled procedure. Initiation of programmed contributions stills an endeavor [42].

d. Challenge of Security and Privacy:

Issues of security and privateness in Internet of Things wind up more noteworthy clear than a customary system. Notwithstanding there exist an outstanding wide assortment of specialists in insurance and privateness, there's a constant interest for security wellbeing and secret privateness of records. Today's, client's realities have an inside and out security, so privateness assurance is an enormous issue. Security models which can be composed presently may not be ideal for Internet of Things structures [43, 44].

Endorsement of most recent innovation and contributions depend on trustfulness of certainties and security of data and its privateness.

e. Challenge of Hardware:

Keen gadgets with more noteworthy between instrument correspondence will prompt shrewd frameworks with unnecessary degrees of insight. There are 5 requesting circumstances that face equipment in Internet of Things, esteem, power and quality, condition related inconveniences, network, and upkeep. Web of Things associations depend upon remote that moderately low expense and incidental size [45]. Equipment gadgets must be intended to apply the littlest measure of power and long-lasting battery. The external condition can likewise affect the equipment effectiveness as contamination, dampness, and warming. The association ought to be solid and adaptable and now not depend handiest on remote, the Internet or records should be permitted.

It is costly to keep harms in detecting devices, so insurance and guide should be neighborhood [46, 47].

f. Challenge of Standard:

Measures make an essential endeavor in creating Internet of Things. A broad is vital to allow smooth and equivalent access and use to all performing artists. Standard and idea characteristics will rouse the change of Internet of Things foundations and projects, administrations and contraptions. Institutionalization lets in item and contributions to do the incredible. The institutionalization could be extreme because of sizable speed in Internet of Things. Conventions and multi-equalities can expand institutionalization. It must be open. Moreover, the standard improvement framework should be available to all on-screen characters and the following well known must be open and free [48].

g. Strategies for Development:

Web of Things has been advanced in one of a kind districts and states in 3 principal designs and probabilities financing strategy. In the states together with the USA, the brief timeframe period respect fund weight of the advancement of cunning power, sharp towns, and RFIDs. Through the online life arrange, a couple of administrations, and bundles, together with locale based absolutely contributions, expanded truth, and cell phones, are primary to the advancement of Internet of Things. Despite the fact that it isn't in every case yet evident which procedure is all the more ground-breaking, every one of them can support Internet of Things and its projects. Be that as it may, an approach to decide the endeavors of accessible sources at an arranged level obtains each other task [26].

h. Business Challenge:

The issue is that there might be no arrangement of business venture period set of guidelines to fit as a fiddle all. The Internet of Things is avoidance to regular business endeavor variant. In the initial phase in business undertaking rendition advancement in Internet of Things, endeavor necessities must start with diminishing device disappointment [49, 50].

i. Challenges for Data Processing:

Information handling is a critical resources in the Internet of Things. By taking a gander at the interconnecting gadgets and devices that exchange stand-out sorts of data, the subsequent gathered data has a top to bottom degree. The capacity records focuses that store this following information will require more spaces, power and power resources. This data require association and handling. Semantic realities combination models might be utilized for extricating that implies from insights. Additionally, engineered insight calculations should be suggested to harvest which implies from these repetitive records. Information carport and examination will be an inconvenience amid all worldwide will be connected through Internet of Things. Dealing with out the majority of the information from the Internet of Things is a training in Big information that executed 3 most vital advances: realities ingestion,

actualities carport, and examination [24, 51]. Internet of thing is very important for everyone in current scenario. It is widely useful in multiple applications like human healthcare systems, traffic monitoring systems and environments monitoring systems etc. The IoT can make the human life easier. The human health care system is widely used system that provides the online record of health for a person. The environment tracking system can help us to track the present environments condition for any location. The traffic intensity is also a big problem in current scenario. This problem can be solving out by using the Internet of thing. The traffic can be monitor and controlled with the help of IoT. Some researchers are also doing funded project of IoT. These projects will be very helpful for the society. So it is necessary to discuss about the recent trends of Internet of things.

Consequently, associations need to acclimatize new advances like Map Reduce and Hadoop. It must be fit for give enough circles, organize, and register capacity to keep with the inflow of late insights, numerous measuremens preparing challenges are listed inside the accompanying subsections.

9 Conclusions

Big data and IoT are widely used in many applications worldwide. Many researchers are working day night to improve the services of Big data and IoT. There are many deficiencies are present in both the technologies. And the most common is its security. Big data and IoT both require the concern about its security. The reason behind is that, the Big data and IoT applications are accessing the use of cloud widely.

And in many cases, the data stored to cloud is very secret. So from the security point of view, it is necessary to look these technologies seriously. Some researchers are also working on RFID and Internet of Things, like a combine approach. RFID is also a latest technology and due to its deficiencies, RFID technology is extracting out by many vendors. Big data and IoT are widely used in many applications worldwide. Many researchers are working day night to improve the services of Big data and IoT. There are many deficiencies are present in both the technologies. And the most common is its security. Big data and IoT both requires the concern about its security. The reason behind is that, the Big data and IoT applications are accessing the use of cloud widely. In UK, big numbers of RFID cards have been deployed in many places but it failed due to lacking in security. To improve RFID security, researchers are also having a look on IOT. The question is what outcome will be. In this chapter, some applications are discussed and try to explain the utilization of Big data and IoT in brief. Secondly, the deficiencies are also the matter of concern in the chapter. The desired solutions to overcome the drawbacks of IoT and bog data are also discussed.

Lot of applications are recently comes in trend that links to Big data and IoT. It is very important to learn and discuss about these recent trends. Today, many applications are directly or indirectly linked to Big data and IoT. Out of these, the use of IoT in healthcare, home security, human tracking are widely acceptable by the world. Yes, while we asking about the advantages of any technology then few

drawbacks and sophisticated issue are also be present there. So in this chapter I am discussing about these advantages along with few drawbacks of Big data and IoT [52].

References

1. C. Lee, C. Yeung, M. Cheng, Research on iot based cyber physical system for industrial big data analytics, in *Industrial Engineering and Engineering Management (IEEM), 2015 IEEE International Conference on* (IEEE, 2015), pp. 1855–1859
2. P. Rizwan, K. Suresh, M.R. Babu, Real-time smart traffic management system for smart cities by using internet of things and big data, in *Emerging Technological Trends (ICETT), International Conference on* (IEEE, 2016), pp. 1–7
3. Q. Zhang, X. Zhang, Q. Zhang, W. Shi, H. Zhong, Firework: big data sharing and processing in collaborative edge environment, in *Hot Topics in Web Systems and Technologies (HotWeb), 2016 Fourth IEEE Workshop on* (IEEE, 2016), pp. 20–25
4. M.M. Rathore, A. Ahmad, A. Paul, Iot-based smart city development using big data analytical approach, in *Automatica (ICA-ACCA), IEEE International Conference on* (IEEE, 2016), pp. 1–8
5. B. Ahlgren, M. Hidell, E.C.-H. Ngai, Internet of things for smart cities: Interoperability and open data. *IEEE Int. Comput.* **20**(6), 52–56 (2016)
6. J.L. P'erez, D. Carrera, Performance characterization of the servioticity api: an iot-as-a-service data management platform, in *Big Data Computing Service and Applications (BigDataService), 2015 IEEE First International Conference on* (IEEE, 2015), pp. 62–71
7. F. Alam, R. Mehmood, I. Katib, A. Albeshri, Analysis of eight data mining algorithms for smarter internet of things (iot). *Procedia Comput. Sci.* **98**, 437–442 (2016)
8. H. Wang, O.L. Osen, G. Li, W. Li, H.-N. Dai, W. Zeng, Big data and industrial internet of things for the maritime industry in northwestern norway, in *TENCON 2015-2015 IEEE Region 10 Conference* (IEEE, 2015), pp. 1–5
9. O.B. Sezer, E. Dogdu, M. Ozbayoglu, A. Onal, An extended iot framework with semantics, big data, and analytics, in *Big Data (Big Data), 2016 IEEE International Conference on* (IEEE, 2016), pp. 1849–1856
10. A.J. Jara, D. Genoud, Y. Bocchi, Big data for cyber physical systems: an analysis of challenges, solutions and opportunities, in *Innovative Mobile and Internet Services in Ubiquitous Computing (IMIS), 2014 Eighth International Conference on* (IEEE, 2014), pp. 376–380
11. C. Vuppapalapati, A. Ilapakurti, S. Kedari, The role of big data in creating sense ehr, an integrated approach to create next generation mobile sensor and wearable data driven electronic health record (ehr), in *Big Data Computing Service and Applications (BigDataService), 2016 IEEE Second International Conference on* (IEEE, 2016), pp. 293–296
12. Z. Ding, X. Gao, J. Xu, H. Wu, Iot-statisticdb: a general statistical database cluster mechanism for big data analysis in the internet of things, in *Green Computing and Communications (Green-Com), 2013 IEEE and Internet of Things (iThings/CPSCoM), IEEE International Conference on and IEEE Cyber, Physical and Social Computing* (IEEE, 2013), pp. 535–543
13. I.-L. Yen, G. Zhou, W. Zhu, F. Bastani, S.-Y. Hwang, A smart physical world based on service technologies, big data, and game-based crowd sourcing, in *Web Services (ICWS), 2015 IEEE International Conference on* (IEEE, 2015), pp. 765–772
14. A. Ahmad, M.M. Rathore, A. Paul, S. Rho, Defining human behaviors using big data analytics in social internet of things, in *Advanced Information Networking and Applications (AINA), 2016 IEEE 30th International Conference on* (IEEE, 2016), pp. 1101–1107
15. D. Arora, K.F. Li, A. Loffler, Big data analytics for classification of network enabled devices, in *Advanced Information Networking and Applications Workshops (WAINA), 2016 30th International Conference on* (IEEE, 2016), pp. 708–713

16. R.P. Minch, Location privacy in the era of the internet of things and big data analytics, in *System Sciences (HICSS), 2015 48th Hawaii International Conference on* (IEEE, 2015), pp. 1521–1530
17. A. Mukherjee, H.S. Paul, S. Dey, A. Banerjee, Angels for distributed analytics in iot, in *Internet of Things (WF- IoT), 2014 IEEE World Forum on* (IEEE, 2014), pp. 565–570
18. R. Ramakrishnan, L. Gaur, Smart electricity distribution in residential areas: internet of things (iot) based advanced metering infrastructure and cloud analytics, in *Internet of Things and Applications (IOTA), International Conference on* (IEEE, 2016), pp. 46–51
19. M.H. Berlian, T.E.R. Sahputra, B.J.W. Ardi, L.W. Dzatmika, A.R.A. Besari, R.W. Sudibyo, S. Sukaridhoto, Design and implementation of smart environment monitoring and analytics in real-time system framework based on internet of underwater things and big data, in *Electronics Symposium (IES), 2016 International* (IEEE, 2016), pp. 403–408
20. D. Mourtzis, E. Vlachou, N. Milas, Industrial big data as a result of iot adoption in manufacturing. *Procedia CIRP* **55**, 290–295 (2016)
21. B. Cheng, A. Papageorgiou, F. Cirillo, E. Kovacs, Geelytics: geo-distributed edge analytics for large scale iot systems based on dynamic topology, in *Internet of Things (WF-IoT), 2015 IEEE 2nd World Forum on* (IEEE, 2015), pp. 565–570
22. E. Ahmed, M.H. Rehmani, Introduction to the special section on social collaborative internet of things, p. 382384 (2017)
23. M.M. Rathore, A. Ahmad, A. Paul, S. Rho, Urban planning and building smart cities based on the internet of things using big data analytics. *Comput. Netw.* **101**, 63–80 (2016)
24. G. Suci, V. Suci, A. Martian, R. Craciunescu, A. Vulpe, I. Marcu, S. Halunga, O. Fratu, Big data, internet of things and cloud convergence—an architecture for secure-health applications. *J. Med. Syst.* **39**(11), 1–8 (2015)
25. F. Bonomi, R. Milito, J. Zhu, S. Addepalli, Fog computing and its role in the internet of things, in *Proceedings of the first edition of the MCC workshop on Mobile cloud computing* (ACM, 2012), pp. 13–16
26. S. Tanwar, S. Tyagi, S. Kumar, The role of internet of things and smart grid for the development of a smart city, in *Intelligent Communication and Computational Technologies (Lecture Notes in Networks and Systems: Proceedings of Internet of Things for Technological Development, IoT4TD 2017)*, Springer International Publishing, vol. 19, pp. 23–33
27. N. Mishra, C.C. Lin, H.T. Chang, A cognitive adopted framework for IoT big-data management and knowledge discovery prospective. *Int. J. Distrib. Sens. Netw.* **2015**, 6 (2015)
28. D. Slezak, P. Synak, J. Wróblewski, G. Toppin, Infobright analytic database engine using rough sets and granular computing, in *Granular Computing (GrC), 2010 IEEE International Conference on* (IEEE, 2010), pp. 432–437
29. A. Mukherjee, S. Dey, H.S. Paul, B. Das, Utilizing condor for data parallel analytics in an iot contextan experience report, in *Wireless and Mobile Computing, Networking and Communications (WiMob), 2013 IEEE 9th International Conference on* (IEEE, 2013), pp. 325–331
30. A. Ahmed, E. Ahmed, A survey on mobile edge computing, in *Intelligent Systems and Control (ISCO), 2016 10th International Conference on* (IEEE, 2016), pp. 1–8
31. H.R. Arkian, A. Diyanat, A. Pourkhalili, Mist: fogbased data analytics scheme with cost-efficient resource provisioning for iot crowdsensing applications. *J. Netw. Comput. Appl.* **82**, 152–165 (2017)
32. H. Aly, M. Elmogy, S. Barakat, Big data on internet of things: Applications, architecture, technologies, techniques, and future directions. *Int. J. Comput. Sci. Eng. (IJCSE)*, **4**, 300–313 (2015)
33. I.A.T. Hashem, N.B. Anuar, A. Gani, I. Yaqoob, F. Xia, S.U. Khan, Mapreduce: review and open challenges. *Scientometrics*, 1–34 (2016)
34. F. Farber, S.K. Cha, J. Primsch, C. Bornhövd, S. Sigg, W. Lehner, Sap hana database: data management for modern business applications. *ACM Sigmod Rec.* **40**(4), 45–51 (2012)
35. E. Ahmed, M.H. Rehmani, Mobile edge computing: opportunities, solutions, and challenges, pp. 59–63

36. R. Tonjes, P. Barnaghi, M. Ali, A. Mileo, M. Hauswirth, F. Ganz, S. Ganea, B. Kjærsgaard, D. Kuemper, S. Nechifor et al., Real time iot stream processing and large-scale data analytics for smart city applications, in *Poster Session, European Conference on Networks and Communications* (2014)
37. M. Villari, A. Celesti, M. Fazio, A. Puliafito, Alljoyn lambda: an architecture for the management of smart environments in iot, in *Smart Computing Workshops (SMARTCOMP Workshops), 2014 International Conference on* (IEEE, 2014), pp. 9–14
38. M.A. Hayes, M.A.M. Capretz, Contextual anomaly detection in big sensor data, in *IEEE International Congress On Big Data*, 2014, pp. 64–70
39. U. Shaukat, E. Ahmed, Z. Anwar, F. Xia, Cloudlet deployment in local wireless networks: Motivation, architectures, applications, and open challenges. *J. Netw. Comput. Appl.* **62**, 18–40 (2016)
40. J. Nandimath, E. Banerjee, A. Patil, P. Kakade, S. Vaidya, D. Chaturvedi, Big data analysis using apache hadoop, in *Information Reuse and Integration (IRI), 2013 IEEE 14th International Conference on* (IEEE, 2013), pp. 700–703
41. V. Morabito, Managing change for big data driven innovation, in *Big Data and Analytics* (Springer, 2015), pp. 125–153
42. S. Burke, Hp haven big data platform is gaining partner momentum, *CRN [online]* <http://www.crncom/news/applications-os/240161649> (2013)
43. A. Bhardwaj, S. Bhattacharjee, A. Chavan, A. Deshpande, A.J. Elmore, S. Madden, A.G. Parameswaran, Datahub: collaborative data science and dataset version management at scale, *arXiv preprint arXiv:1409.0798* (2014)
44. J. Jin, J. Gubbi, T. Luo, M. Palaniswami, Network architecture and qos issues in the internet of things for a smart city, in *Communications and Information Technologies (ISCIT), 2012 International Symposium on* (IEEE, 2012), pp. 956–961
45. 2017, Accessed on 3rd June) Hortonworks. [Online]. <https://hortonworks.com/>
46. Y. Zhuang, Y. Wang, J. Shao, L. Chen, W. Lu, J. Sun, B. Wei, J. Wu, D-ocean: an unstructured data management system for data ocean environment. *Front. Comput. Sci.* **10**(2), 353–369 (2016). <http://dx.doi.org/10.1007/s11704-015-5045-6>
47. Z. Ding, Q. Yang, H. Wu, Massive heterogeneous sensor data management in the internet of things, in *IEEE International Conferences On Internet Of Things, And Cyber, Physical And Social Computing*, pp. 100–108 (2011)
48. 2017, Accessed on 3rd June) Mapr. [Online]. <https://mapr.com>
49. E. Al Nuaimi, H. Al Neyadi, N. Mohamed, J. AlJaroodi, Applications of big data to smart cities. *J. Int. Serv. Appl.* **6**(1), 1 (2015)
50. E. Ahmed, M. Imran, M. Guizani, A. Rayes, J. Lloret, G. Han, W. Guibene, Enabling mobile and wireless technologies for smart cities: Part 2. *IEEE Commun. Mag.* **55**(3), 12–13 (2017)
51. S. Tanwar, P. Patel, K. Patel, S. Tyagi, N. Kumar, M.S. Obaidat, An advanced internet of thing based security alert system for smart home, in *International Conference on Computer, Information and Telecommunication Systems (IEEE CITS-2017)*, Dalian University, Dalian, China, 21–23 July 2017, pp. 25–29
52. R. Sharma, Steps for implementing big data and its security challenges, of the book titled “Data Intensive Computing Application for Big Data” to be published by *Advances in Parallel Computing series of IOS PRESS* (Scopus Indexed) ISSN 1879-808X, Vol. 29, February 2018