

See discussions, stats, and author profiles for this publication at: <https://www.researchgate.net/publication/303738671>

An all Optical VCSEL Wavelength Conversion for Optical Fibre Access Networks

Conference Paper · May 2016

DOI: 10.13140/RG.2.2.17836.46722

CITATION

1

READS

110

1 author:



Duncan Boiyo

Machakos University

19 PUBLICATIONS 25 CITATIONS

SEE PROFILE

Some of the authors of this publication are also working on these related projects:



Cheap and energy efficient Flexible technologies for high speed optical fibre communication systems [View project](#)

An all Optical VCSEL Wavelength Conversion for Optical Fibre Access Networks

D. Kiboi Boiyo¹, G.M. Isoe¹, S. Wassin¹, E.K. Rotich Kipnoo², R.R. Gamatham³, A.W.R. Leitch¹ and T.B. Gibbon¹

Abstract—a cheap, scalable and efficient optical wavelength conversion and optical path switching technique for access networks is experimentally demonstrated. Wavelength conversion is used in wavelength division multiplexed (WDM) systems and networks to accommodate multiple channels within a single optical fibre link. This technique can be used to route data from one wavelength to an idle path/wavelength hence improve efficient channel utilization in the grid. In this paper, the process of wavelength conversion has been experimentally realized by optically injecting a vertical cavity surface emitting laser (VCSEL) master laser into the side-mode of a second laser VCSEL cavity (slave). This paper provides a 10 dB extinction ratio of the dominant wavelength in the slave VCSEL laser within the 1550 nm wavelengths transmission region. This study is relevant to reconfigurable metro-access networks for wavelength and path assignment in optical fibre transport, which forms the backbone for high speed optical data transport. With distinct wavelength assignment and conversion, an optical switch can be used to direct and redirect a wavelength to the designated user at the terminal of an access network.

Keywords—Access Networks, Optical Fibre, Wavelength Conversion

I. INTRODUCTION

Wavelength division multiplexing (WDM) is an effective technique for adding new wavelengths onto an optical network to distinctively identify and allocate wavelength destinations. In a typical WDM optical network, wavelength collisions can be overcome by using flexible wavelength converters. An all-optical (without optical-electrical-optical conversion) wavelength conversion and WDM techniques can therefore be used to increase the network capacity for efficient utilization of available bandwidth and allow wavelength reuse [1]. Several methods of wavelength conversion have been reported: Optoelectronic converters, laser converters and coherent converters [2]. All optical wavelength converters include nonlinear optical gating based on fibre loop, cross-gain modulation, cross-phase modulation and four-wave mixing based on semiconductor optical amplifier [3]. Laser tunability is the key part of optical

wavelength conversion. Different tunable sources have been previously used: micro-electro mechanical external cavity diode lasers (MEM-ECL), multi-section DFB lasers and MEM-VCSEL. However, it has been reported that achieving wavelength conversion using MEM-ECL or MEM-VCSEL is difficult since external optical injection on the laser cavity is impossible [4].

This paper reports a low power purely optical wavelength conversion based on laser wavelength injection on the side-mode of a vertical cavity surface emitting laser (VCSEL). The VCSEL laser cavity is current-driven and its wavelength can be tuned [5]. In this scheme, a master VCSEL has been injected into the side-mode of a second slave VCSEL with laser gain saturation being the principle technique of conversion. A wavelength conversion has been achieved for 1550 nm transmission window which is the low attenuation wavelength in optical fibre transmissions. Finally, a 10 dB extinction ratio of the dominant wavelength of the slave laser is reported.

II. THEORY

A. VCSEL TECHNOLOGY

A VCSEL comprises of a gain medium which is an active region sandwiched between a pair of distributed Bragg reflectors (DBRs) as shown in Fig.1. The emitted light from a VCSEL is perpendicular to the active region. Moreover, this active region receives current through proton injection or through an oxide aperture [6].

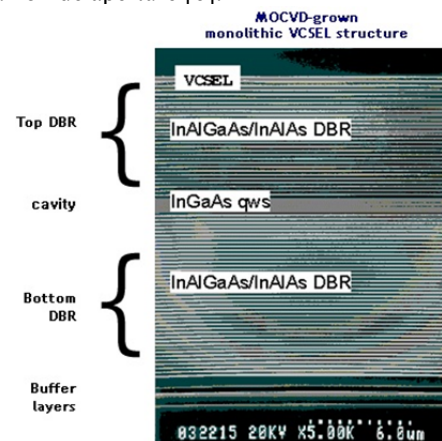

FIG.2 THE STRUCTURE OF THE RAYCAN VCSEL [7]

The spectral mode spacing $\Delta\lambda$, of a VCSEL is given by (1);

$$\Delta\lambda = \lambda^2 / 2n_{eff}L_{eff} \quad (1)$$

¹Duncan KiboiBoiyo, George Isoe, ShukreeWassin, Andrew Leitch and Tim Gibbon, Centre for Broadband Communications, NMMU, South Africa (phone:+27415042141; fax:+27415042173;

Email: Duncan.Boiyo@nmmu.ac.za/ dkiboiyo08@yahoo.com).

²Enoch Kirwa Rotich, University of Kabianga, Kenya, Email: ekipnoo@gmail.com

³Romeo Gamatham, The Square Kilometre Array (SKA) Project, South Africa. Email: rgamatham@ska.ac.za

where λ is the emission wavelength, n_{eff} is the average refractive index of the mirrors and L_{eff} is the total cavity length which is the sum of the active region thickness and the penetration depth of the electric field into the DBR [8].

A VCSEL has several advantages: Low power, wavelength tunability, low cost, high power per unit area, easily coupled circular beam, high temperature operation and direct data modulation [9].

III. SYSTEM OF OPERATION

An incident beam from the master laser with wavelength λ_i is injected into the laser cavity of a multimode tunable laser. Wavelength tuning is done to 'lock' the side-mode of the tunable laser to λ_i . The side-mode is therefore stimulated with increase in injected power from λ_i . As a result, λ_i is converted to a 'new' lasing wavelength λ_c due to gain saturation as shown in Fig. 2.

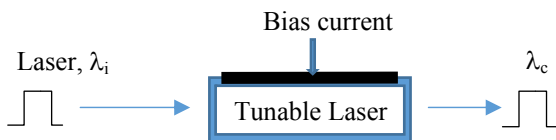

FIG. 2 AN ALL OPTICAL WAVELENGTH CONVERSION USING TWO LASERS [2]

IV. EXPERIMENTAL DESIGN

To achieve an all optical wavelength conversion, two tunable VCSELs within 1550 nm range are used as shown in Fig. 3. VCSEL 1 is used as a master laser that carries data at wavelength λ_i while VCSEL 2 is the slave tunable laser responsible for wavelength conversion. Band-pass filters (BPFs) are used to filter out the undesired wavelengths in this scheme. An Erbium-doped fibre amplifier (EDFA) is used to increase the injected power so as to achieve the necessary gain saturation necessary for conversion within the VCSEL 2 cavity. Moreover, a 10/90 optical coupler is used to monitor the injected power through a power meter (PM). An isolator prevents backscattered light from the circulator and VCSEL 2. A 3 dB coupler is used to monitor the converted light through a power meter (PM) and an optical spectrum analyzer (OSA).

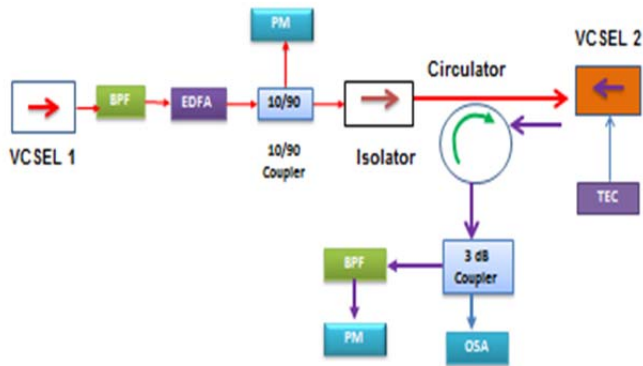

FIG. 3 A SCHEMATIC OF AN ALL OPTICAL WAVELENGTH CONVERSION USING TWO VCSEL LASER SOURCES

The circulator directs the injection beam from VCSEL 1 and also enables the converted beam of light from VCSEL 2

to be received at the 3 dB coupler. The side-mode of VCSEL 2 is filtered out by BPF for perfect wavelength conversion. Theoptical spectra areobserved using the optical spectrum analyzer (OSA). The converted wavelength λ_c is monitored through the power meter after filtering out the side-modes from VCSEL 2 using a BPF. The VCSEL temperature is maintained and controlled at 25⁰ C using a thermoelectric cooler (TEC).

V. RESULTS AND DISCUSSION

A VCSEL is a low power laser that requires mA range drive current and it can be biased by increasing the driving current as shown in Fig. 4. VCSEL 2 was biased by increasing the current 0-9 mA. It shows that VCSEL 2 has a lasing threshold of 1 mA bias current. The ability to tune the wavelength of the VCSEL is illustrated in the inset of Fig. 4. By increasing the bias current from 2-7 mA, the VCSEL can achieve a 1547.77-1551.18 nm tunability which translates to 3.4 nm or 425 GHz bandwidth. This makes the VCSEL to be an ideal component for wavelength conversion and WDM transmission.

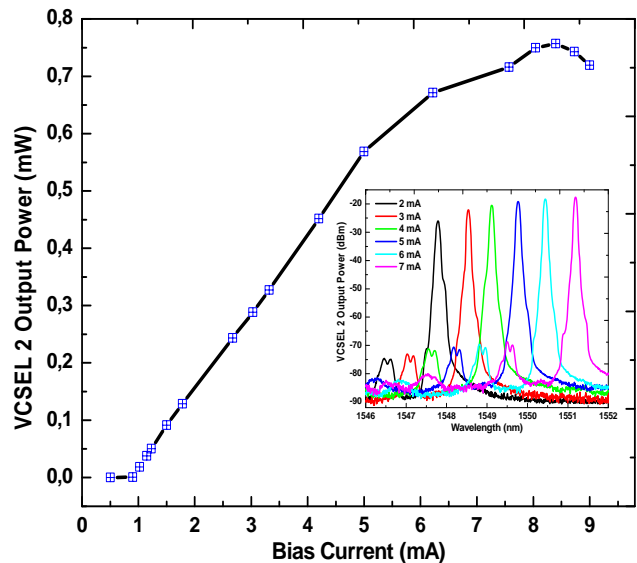

FIG.4 VCSEL BIASING AND WAVELENGTH TUNABILITY (INSET)

The VCSEL has two modes; the dominant and the side-modes with a side-mode suppression ratio (SMSR) of 52 dB as shown in Fig. 5. The wavelength to be converted λ_i is optically injected into the side-mode of the slave VCSEL. The side-mode and dominant mode wavelength difference for VCSEL 2 is 1.6 nm (200 GHz). As observed in Fig. 5, the side-mode has two peaks with a 0.12 nm spacing which results in the drifting of λ_i during injection.

To convert a wavelength at 1548.5 nm, the slave VCSEL 2 is tuned so that its side-mode coincides with the master wavelength as shown in Fig. 6. Without optical injection, the dominant mode of the slave is "HIGH" or logically "1". By injecting a laser beam into the side-mode, the dominant mode of VCSEL 2 is suppressed to a "LOW" or logic "0".

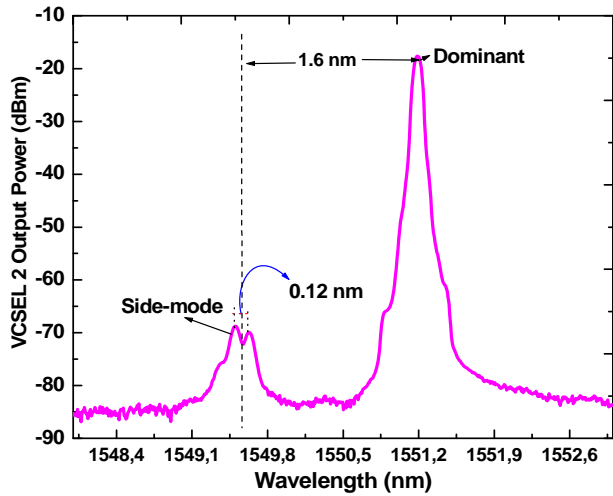

FIG.5 SHOWS THE TWO MODES OF THE SLAVE VCSEL: THE DOMINANT AND SIDE-MODES

If the injection beam has sufficient power, the side-mode lases dominantly as shown in Fig. 6 and hence the wavelength conversion. The difference in power of the dominant mode with and without injection gives its extinction ratio.

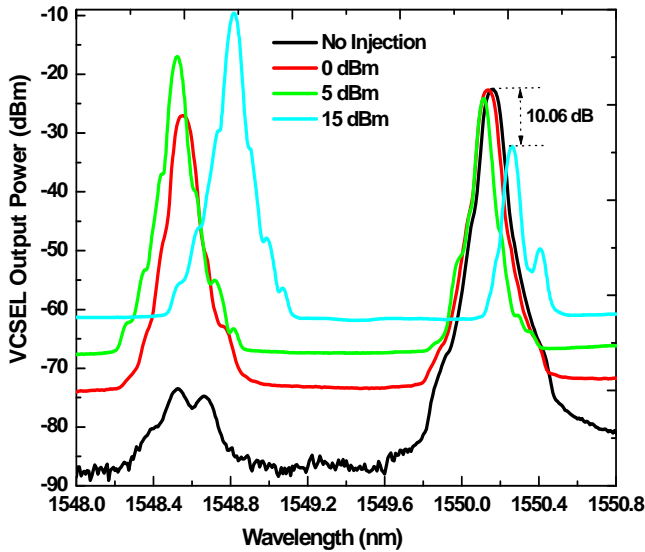

FIG.6 SHOWS SIDE-MODE WITH AND WITHOUT EXTERNAL OPTICAL INJECTION

The slave laser was biased above its lasing threshold at 5.27 mA and 6.3 mA to produce -5 dBm and -4 dBm of power respectively. This high power ensures that the converted signal (beam) can be transmitted for a longer distance.

At low injection power, the side-mode is not lased due to insufficient lasing power. An increase in injected power, reduces the output power of the dominant mode of VCSEL 2 as shown in Fig. 7. For -5 dBm, a significant suppression of the dominant mode is observed with a 10 dBm injected power.

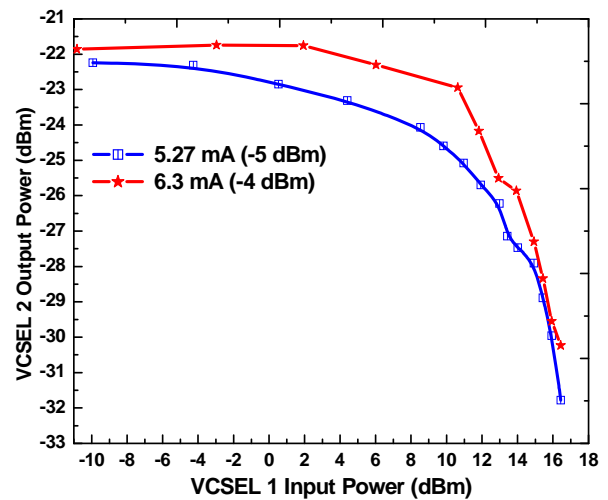

FIG.7SHOWS THE OUTPUT POWEROF THE DOMINANT MODE OF VCSEL 2 AS OBSERVED FROM THE OSA WITH INCREASE IN INJECTION POWER.

Extinction ratios of 10 dB and 8.3 dB were achieved by injecting a 16 dBm beam into a -5 dBm and -4 dBm as shown in Fig.8. The increase in injected power results in side-mode lasing dominantly while turning “OFF” the dominant mode and therefore wavelength conversion.

Since there is data inversion due to data transmitted by the master laser being converted to a new wavelength λ_c , the optical receiver receives inverted data for demodulation.

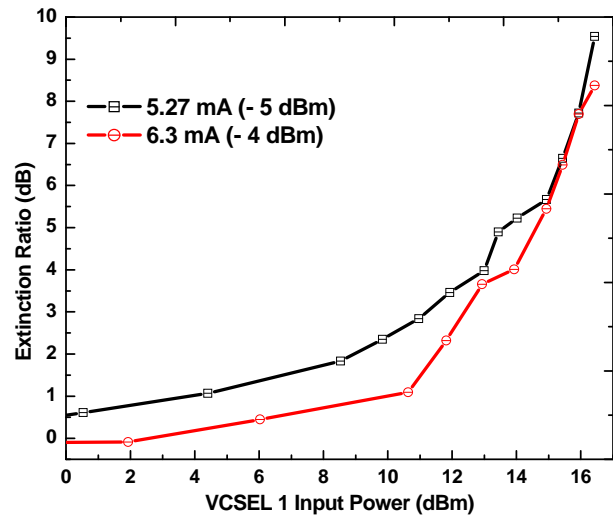

FIG.8ILLUSTRATES THE EXTINCTION RATIO WITH INCREASE IN INJECTION POWER

Data that was transmitted by $a\lambda_i$ carrier can therefore be transferred and transmitted by a converted λ_c carrier. This implies that data can be routed and rerouted through a network by utilization of wavelength conversion. As a result, wavelength collisions can be avoided in WDM systems and in typical mesh-ring networks.

VI. CONCLUSION

A cheaper and low power all optical wavelength conversion using a VCSEL has been experimentally demonstrated

providing an extinction ratio of 10 dB. The side-mode and dominant modes of the VCSELs can be tuned to fit into a standard international telecommunication union (ITU) 200 GHz Grid for wavelength reuse in reconfigurable optical fibre networks. This work also offers low power, cheap and effective VCSEL technology for wavelength conversion in optical access networks.

ACKNOWLEDGEMENT

We are grateful for equipment and research support from: SKA-SA, Cisco, DST, CSIR, ALC, NRF, NLC, THRIP, Telkom, Dartcom and Ingoma Communication Services.

REFERENCES

- [1] S. L. Jansen, et al, "Wavelength conversion of a 40-Gb/s NRZ signal across the entire c-band by an asymmetric Sagnac Loop", *IEEE Photonics Technology Letters*, Vol. 17, No. 10, pp. 2137-2139, Oct 2005.
- [2] K. E. Stubkjaer, et al, "Wavelength Converter technology", *IEICE Trans. Electron.*, Vol. E82-C, No. 2, pp. 338-348, February 1989.
- [3] Yingchen Wu, et al, "All-optical Wavelength Conversion using Optical injection induced wavelength switching in V-cavity laser", *Progress in Electromagnetics Research Symposium Proceedings, Guangzhou, China*, pp. 915-919, Aug. 25-28, 2014.
- [4] Kwang-Hyun Lee, et al "A Tunable-Output Wavelength Converter based on a self-seeded Fabry-Perot Laser Diode with a chirped fibre grating", *Microwave And Optical Technology Letters*, Vol. 37, No. 1, Apr 5, 2003.
- [5] R. Michalzik, (Ed.), *VCSELs: Fundamentals, technology and applications of vertical-cavity surface-emitting lasers*, Springer, Berlin Heidelberg, 2013.
- [6] Raycan, <http://www.raycan.com/tech.html>. Accessed 16th March 2016.
- [7] Raycan, 1310 nm / 1550 nm VCSEL structure in RayCan. http://www.raycan.com/tech_8.html. Accessed 9th Feb 2016.
- [8] Finisar, <http://www.myvcsel.com/designing-with-vcsels/>, in, 2013. Accessed 9th Feb 2016.
- [9] Finisar, Optical Modes in VCSEL. https://www.finisar.com/sites/default/files/downloads/application_note_vcsel_optical_modes.pdf. Accessed on 16th March 2016